

EDANUSA

F6, F6 Express

Fetal & Maternal Monitor

Version 1.5

CE₀₁₂₃

About this Manual

P/N: 01.54.109276-15

Release Date: Apr. 2012

© Copyright EDAN INSTRUMENTS, INC. 2008 - 2012. All rights reserved.

Statement

This manual will help you understand the operation and maintenance of the product better. It is reminded that the product shall be used strictly complying with this manual. User's operation failing to comply with this manual may result in malfunction or accident for which EDAN INSTRUMENTS, INC. (hereinafter called EDAN) can not be held liable.

EDAN owns the copyrights of this manual. Without prior written consent of EDAN, any materials contained in this manual shall not be photocopied, reproduced or translated into other languages.

Materials protected by the copyright law, including but not limited to confidential information such as technical information and patent information are contained in this manual, the user shall not disclose such information to any irrelevant third party.

The user shall understand that nothing in this manual grants him, expressly or implicitly, any right or license to use any of the intellectual properties of EDAN.

EDAN holds the rights to modify, update, and ultimately explain this manual.

Responsibility of the Manufacturer

EDAN only considers itself responsible for any effect on safety, reliability and performance of the equipment if:

Assembly operations, extensions, re-adjustments, modifications or repairs are carried out by persons authorized by EDAN, and

The electrical installation of the relevant room complies with national standards, and

The instrument is used in accordance with the instructions for use.

Upon request, EDAN may provide, with compensation, necessary circuit diagrams, and other information to help qualified technician to maintain and repair some parts, which EDAN may define as user serviceable.

Terms Used in this Manual

This guide is designed to give key concepts on safety precautions.

WARNING

A **WARNING** label advises against certain actions or situations that could result in personal injury or death.

CAUTION

A **CAUTION** label advises against actions or situations that could damage equipment, produce inaccurate data, or invalidate a procedure.

NOTE

A **NOTE** provides useful information regarding a function or a procedure.

Table of Contents

Chapter 1 Safety Guide	1
1.1 Intended Use.....	1
1.2 Features	2
1.3 Instruction for Safe Operation.....	2
1.4 Ultrasound Safety Guide	3
1.5 Safety Precautions.....	3
1.6 Definitions and Symbols	8
Chapter 2 Installation Guide.....	11
2.1 Opening and Checking Package.....	11
2.2 Installing Battery	11
2.3 Installing Monitor	13
2.4 Connecting Power Cable.....	13
Chapter 3 Monitor and Accessories	14
3.1 Overview	14
3.1.1 Keys and Control Knob.....	15
3.1.2 Indicators.....	17
3.2 Accessories.....	18
3.2.1 Ultrasound (US) Transducers.....	18
3.2.2 TOCO Transducers	18
3.2.3 Belt	19
3.2.4 Remote Event Marker	19
3.2.5 Fetal Stimulator.....	19
3.2.6 DECG Cable.....	20
3.2.7 Fetal Spiral Electrode.....	20
3.2.8 IUP Cable	21
3.2.9 IUP Catheter.....	21
3.2.10 ECG Cable	21
3.2.11 SpO ₂ Transducer	22
3.2.12 NIBP Cuff.....	22
3.2.13 TEMP Transducer	22
3.3 Screen.....	23
3.3.1 Main Interface	23
3.3.2 Setup Interface	25
3.4 Ordering Information	26
Chapter 4 Alarms.....	28
4.1 Alarm Classification.....	28
4.2 Audible Alarm.....	28
4.3 Visual Alarm	29
4.4 Choosing Alarm Display Form	29
4.5 Changing Alarm Volume	29
4.6 Choosing Alarm Silence Duration	30
4.7 Choosing Signal Loss Delay	30
4.8 Reviewing Alarms.....	30
4.9 Alarm Treatment Measures.....	30

4.10 Testing Alarms	31
4.11 Patient Alarm Defaults	31
Chapter 5 Printing	33
5.1 Function Description	33
5.2 Printing Configuration	34
5.2.1 Switching Auto Start Printing On or Off	34
5.2.2 Choosing Paper Speed	34
5.2.3 Changing Print Timer	34
5.2.4 Switching Print Self-Check On or Off	35
5.2.5 Changing Printing End Volume	35
5.3 Understanding Recorder Paper Printout	35
Chapter 6 Pre-Monitoring Preparation	37
6.1 Loading Recorder paper	37
6.2 Switching On	39
6.3 Checking Recorder Paper	39
6.4 Adjusting Screen Angle	40
6.5 Setting Date and Time	41
6.6 Connecting Transducers	41
6.7 Placing Accessories in the Holder	42
6.8 Adjusting Volume	43
Chapter 7 Fetal Monitoring	44
7.1 Confirming Fetal Life	44
7.2 Monitoring FHR with Ultrasound	44
7.2.1 Parts Required	44
7.2.2 FHR Monitoring Procedure	45
7.2.3 Switching FHR Alarm On or Off	46
7.2.4 Changing FHR Alarm Limits	46
7.2.5 Changing FHR Alarm Delay	47
7.3 Monitoring FHR with DECG (F6)	47
7.3.1 Contraindications	47
7.3.2 Parts Required	47
7.3.3 Preparing Patient's Skin Prior to Placing Electrodes	48
7.3.4 Switching DECG Beep On or Off	48
7.3.5 Switching the Artifact Suppression On or Off	48
7.3.6 Directions for Using Fetal Spiral Electrode	49
7.3.7 DECG Monitoring Procedure	50
7.3.7 Detaching Fetal Spiral Electrode	50
7.4 Monitoring Twin FHRs	50
7.4.1 Monitoring Twins Externally	50
7.4.2 Monitoring Internally	51
7.4.3 Signals Overlap Verification (SOV)	51
7.4.4 Changing FHR2 Offset	51
7.5 Monitoring Uterine Activity Externally	52
7.5.1 Parts Required	52
7.5.2 TOCO Monitoring Procedure	52
7.5.3 Changing UA Baseline	53
7.5.4 Testing TOCO Transducers	53
7.6 Monitoring Uterine Activity Internally (F6)	54

7.6.1	Parts Required	54
7.6.2	Directions for Use of IUPC	54
7.6.3	IUP Monitoring Procedure	56
7.6.4	Checking Intrauterine Pressure Cable Function	57
7.7	Monitoring Fetal Movement	57
7.7.1	Auto Fetal Movement Monitoring (AFM)	57
7.7.2	Enabling or Disabling AFM Trace	58
7.7.3	Changing AFM Gain	58
7.7.4	Choosing AFM Mode	58
7.7.5	Changing AFM Threshold	58
7.7.6	Choosing FM Source	59
7.7.7	Manual Fetal Movement Monitoring (MFM)	59
7.7.8	Changing MFM Volume	59
7.8	Start Monitoring	59
7.9	Inputting Maternal Information (Mat. Info)	60
7.9.1	Auto ID	60
7.9.2	Changing Maternal Information	60
7.9.3	Switching Mat. Info Inputting On or Off	61
Chapter 8	Fetal Monitoring Display (F6)	62
8.1	Traces	62
8.1.1	Changing Time Scale	63
8.2	Trace Control Tools	63
8.2.1	Data Saving	64
8.2.2	Searching for a File	64
8.2.3	Reviewing	65
8.2.4	CTG Analysis	66
8.2.5	Marking a Note	68
8.3	Numerics	69
8.4	Fetal Monitoring Alarm Messages	70
8.4.1	Patient Alarm Messages	70
8.4.2	Technical Alarm Messages	70
Chapter 9	Maternal Monitoring (F6 Express)	72
9.1	Maternal ECG Monitoring	72
9.1.1	Introduction	72
9.1.2	How to Place 3-lead ECG Cables	73
9.1.3	ECG Monitoring Procedure	74
9.1.4	Changing ECG Source	74
9.1.5	Changing ECG Gain	74
9.1.6	Enabling ECG Calibration	75
9.2	Maternal SpO ₂ Monitoring	75
9.2.1	Introduction	75
9.2.2	SpO ₂ Monitoring Procedure	77
9.2.3	Enabling SpO ₂ Trace Printing	78
9.2.4	Switching the SpO ₂ Alarm On or Off	78
9.2.5	Changing SpO ₂ Alarm Limits	78
9.3	Maternal HR Monitoring	78
9.3.1	Introduction	78
9.3.2	Choosing HR Source	79
9.3.3	Changing HR Beep Volume	79

9.3.4 Enabling HR Trace.....	79
9.3.5 Switching the HR Alarm On or Off.....	79
9.3.6 Changing HR Alarm Limits.....	80
9.3.7 Signals Overlap Verification.....	80
9.4 Maternal NIBP Monitoring.....	80
9.4.1 Introduction.....	80
9.4.2 How to Apply NIBP Cuff.....	81
9.4.3 Preparation for NIBP Monitoring.....	82
9.4.4 Auto Measurement.....	82
9.4.5 Manual Measurement.....	83
9.4.6 Correcting the Measurement.....	84
9.4.7 Changing NIBP Unit.....	84
9.4.8 Switching the NIBP Alarm On or Off.....	84
9.4.9 Changing SYS Alarm Limits.....	84
9.4.10 Changing DIA Alarm Limits.....	84
9.4.11 Changing MAP Alarm Limits.....	85
9.4.12 Choosing NIBP Printing Mode.....	85
9.5 Maternal TEMP Monitoring.....	85
9.5.1 TEMP Monitoring Procedure.....	85
9.5.2 Changing TEMP Unit.....	86
9.5.3 Switching the TEMP Alarm On or Off.....	86
9.5.4 Changing TEMP Alarm Limits.....	86
Chapter 10 Maternal Monitoring Display (F6 Express).....	87
10.1 Display Mode.....	87
10.2 Maternal Monitoring Traces.....	89
10.3 Maternal Vital Sign List.....	89
10.4 Numerics.....	90
10.5 Maternal Monitoring Alarm Messages.....	91
10.5.1 Patient Alarm Messages.....	91
10.5.2 Technical Alarm Messages.....	92
Chapter 11 After Monitoring.....	94
11.1 Completing Monitoring.....	94
11.2 Switching Off.....	94
Chapter 12 Maintenance and Cleaning.....	95
12.1 Maintenance.....	95
12.1.1 Maintaining Inspection.....	95
12.1.2 Maintenance of Monitor.....	96
12.1.3 Maintenance of Transducers.....	96
12.1.4 Storage of Recorder Paper.....	96
12.1.5 Cleaning of Recorder.....	96
12.1.6 Maintaining the Battery.....	97
12.2 Cleaning.....	97
12.2.1 Cleaning of Monitor.....	97
12.2.2 Cleaning of Accessories.....	98
12.3 Disinfecting.....	100
12.4 Sterilizing.....	100
Chapter 13 Warranty and Service.....	101
13.1 Warranty.....	101

13.2 Contact information	101
Appendix 1 Product Specifications.....	102
A1.1 Environmental Specifications	102
A1.2 Physical Specifications.....	102
A1.3 Performance Specifications.....	104
A1.4 Recorder Specifications.....	107
A1.5 Rechargeable Lithium-ion Battery	108
A1.6 Low Output Summary Table.....	109
Appendix 2 Signal Input/Output Connector	110
Appendix 3 Troubleshooting.....	112
A3.1 No Display.....	112
A3.2 Noise.....	112
A3.3 Recorder Error.....	112
A3.4 Trouble with Ultrasound FHR Monitoring	113
A3.5 Troubles with DECG FHR Monitoring.....	113
A3.6 Troubles with Contractions Monitoring (External).....	114
A3.7 Troubles with Monitoring Contractions (Internal).....	114
A3.8 Big ECG Signal Interference or Thick Baseline	114
A3.9 NIBP and SpO2 No Results	115
A3.10 Blown Fuses	115
Appendix 4 Abbreviation	117
Appendix 5 EMC Information – Guidance and Manufacture’s Declaration.....	118
A5.1 Electromagnetic Emissions – for all EQUIPMENT and SYSTEMS.....	118
A5.2 Electromagnetic Immunity – for all EQUIPMENT and SYSTEMS	119
A5.3 Electromagnetic Immunity – for EQUIPMENT and SYSTEM that are not LIFE-SUPPORTING	121
A5.4 Recommended Separation Distance.....	123
Appendix 6 Limitations of Ultrasonic Monitoring.....	124
A6.1 How Does Ultrasound Work.....	124
A6.2 Artifacts in Fetal Heart Monitoring.....	124
A6.3 Audio Output and Screen Reading.....	126
Appendix 7 Connection of T840 Telemetry System.....	127
A7.1 Connecting T840 Telemetry System.....	127
A7.2 FHR Monitoring with Cordless Transducers	128

Chapter 1 Safety Guide

CAUTION

Federal (U.S.) Law restricts this device to sale by or on the order of a physician.

NOTE:

- 1 In order to ensure the operator and patient's safety, read through this chapter before using this monitor.
- 2 This user manual is written to cover the maximum configuration. Therefore, your model may not have some of the parameters and functions described, depending on what you have ordered.

1.1 Intended Use

F6 Fetal & Maternal Monitor (hereinafter called F6):

The F6 Fetal & Maternal Monitor is intended for non-invasive and invasive monitoring of fetus during antepartum examination, labor and delivery. It is intended to be used only by trained and qualified personnel in antepartum examination rooms, labor and delivery rooms.

F6 Fetal & Maternal Monitor provides Non-Stress testing for pregnant women from the 28th week of gestation. It can externally monitor the FHRs using ultrasound and uterine activity via a TOCO transducer. Alternatively, it can internally monitor one of the FHRs with DECG and uterine activity with an IUPC.

F6 Express Fetal & Maternal Monitor (hereinafter called F6 Express):

F6 Express Fetal & Maternal Monitor is intended for monitoring physiological parameters of pregnant women during antepartum examination, labor and delivery. It is intended to be used only by trained and qualified personnel in antepartum examination rooms, labor and delivery rooms.



F6 Express Fetal & Maternal Monitor is intended for providing Non-Stress testing or fetal monitoring for pregnant women from the 28th week of gestation. In addition, it provides a solution for maternal vital signs monitoring.

Contraindications:

They are not intended for use in intensive care units, operating rooms or for home use.

1.2 Features

The following table lists the measurements that **F6** and **F6 Express** support.





Model	 F6	 F6 Express
Dual-FHR	√	√
TOCO	√	√
FM	√	√
AFM	√	√
DECG/IUP	Opt	×
MECG	×	√
NIBP	×	√
MSpO2	×	√
TEMP	×	√
NOTE: √ = Standard Opt = Optional × = Not Available		

1.3 Instruction for Safe Operation

NOTE:

In this manual, **Monitor** refers to both **F6** and **F6 Express**, and is used where the information applies to both models.

- ◆ The monitor is designed to comply with the international safety requirements IEC/EN 60601-1 for medical electrical equipment. It is class I equipment.
- ◆ The monitor operates within specifications at ambient temperatures between +5°C (+41°F) and +40°C (+104°F). Ambient temperatures that exceed these limits could affect the accuracy of the instrument and cause damage to the modules and circuits. Allow at least 2 inches (5 cm) clearance around the instrument for proper air circulation.
- ◆ You must check that the equipment, cables and transducers do not have visible evidence of damage that may affect patient safety or monitoring capability before use. If damage is evident, replacement is recommended before use.
- ◆ The monitor must be serviced only by authorized and qualified personnel. The manufacturer does not accept responsibility for safety compliance, reliability and performance if modifications or repairs are carried out by unauthorized personnel. Identical replacement parts must be used.
- ◆ The protective categories against electric shock of the patient connections are:

Ultrasound (FHR1, FHR2) External TOCO Fetal Movement Mark (FM) Fetal Stimulator ((FS) Intrauterine Pressure (IUP)	Type BF	
Non-invasive Blood Pressure (NIBP) Arterial Oxygen Saturation (SpO ₂)	Type BF, defibrillation-proof	
Direct Electrocardiography (DECG)	Type CF	
Electrocardiography (ECG) Temperature (TEMP)	Type CF, defibrillation-proof	

The monitor described in this user manual is not protected against:

- a) The effects of high frequency currents.
- b) The interference of electrosurgery equipment.

1.4 Ultrasound Safety Guide

◆ Fetal Use

The monitor is designed for continuous fetal heart rate monitoring during pregnancy and labor. Clinical interpretation of fetal heart rate traces can diagnose fetal and/or maternal problems and complications.

◆ Instructions for Use in Minimizing Patient Exposure

The acoustic output of the monitor is internally controlled and can not be varied by the operator in the course of the examination. The duration of exposure is, however, fully under the control of the operator. Mastery of the examination techniques described in the User Manual will facilitate obtaining the maximum amount of diagnostic information with the minimum amount of exposure. The exercising of clinical judgment in the monitoring of low risk patients will avoid unnecessary insonation.

1.5 Safety Precautions

WARNING and **CAUTION** messages must be observed. To avoid the possibility of injury, observe the following precautions during the operation of the instrument.

WARNING

For using safety:

- 1 The monitor is provided for the use of qualified physicians or personnel professionally trained. They should be familiar with the contents of this user manual before operation.
 - 2 Installation and service should only be performed by qualified service engineers authorized by the manufacturer.
 - 3 The monitor is not intended for use in intensive care units (ICU), operating rooms or for home use.
 - 4 **EXPLOSION HAZARD** - Do not use the monitor in the presence of flammable anesthetics or other materials.
 - 5 **SHOCK HAZARD** - the power receptacle must be a three-wire grounded outlet. Never try to adapt the three-prong plug to fit a two-slot outlet. A hospital grade outlet is required. If the outlet has only two slots, make sure that it is replaced with a three-slot grounded outlet before attempting to operate the monitor.
 - 6 Any non-medical equipment (such as the external printer) is not allowed to be used within the patient vicinity (1.5m/6ft.).
 - 7 Do not use the additional multiple portable socket-outlet or extension cord in the medical electrical system, unless it's specified as part of the system by manufacturer. And the multiple portable socket-outlets provided with the system shall only be used for supplying power to equipment which is intended to form part of the system.
 - 8 If multiple instruments are connected to a patient, the sum of the leakage currents may exceed the limits given in the IEC/EN 60601-1 and may pose a safety hazard. Consult your service personnel.
 - 9 Multiple portable socket-outlets shall not be placed on the floor.
 - 10 Make sure that the power is turned off and the power cord is disconnected from the AC socket before connecting or disconnecting equipment. Otherwise, the patient or operator may receive electrical shock or other injury.
 - 11 Do not connect any equipment or accessories that are not approved by the manufacturer or that are not IEC 60601-1 approved to the monitor. The operation or use of non-approved equipment or accessories with the monitor is not tested or supported, and monitor operation and safety are not guaranteed.
 - 12 **SHOCK HAZARD** - Don't connect non-medical electrical equipment, which has been supplied as a part of the system, directly to the wall outlet when the non-medical equipment is intended to be supplied by a multiple portable socket-outlet with an isolation transformer.
 - 13 **SHOCK HAZARD** - Don't connect electrical equipment, which has not been supplied as a part of the system, to the multiple portable socket-outlets supplying the system.
-
-

WARNING

- 14 Do not use the additional multiple portable socket-outlet or extension cord in the medical electrical system, unless it's specified as part of the system by manufacturer. And the multiple portable socket-outlets provided with the system shall only be used for supplying power to equipment which is intended to form part of the system.
 - 15 Do not exceed the maximum permitted load when using multiple portable socket-outlets to supply the system.
 - 16 Do not touch accessible parts of non-medical electrical equipment and the patient simultaneously.
 - 17 Do not apply this monitor and other ultrasonic equipment simultaneously on a same patient, in case of possible hazard caused by leakage current superposition.
 - 18 Do not apply this monitor simultaneously with other PATIENT-connected equipment, such as, a cardiac pacemaker or other electrical stimulators, on the same patient.
 - 19 The monitor can only be used on one patient at a time.
 - 20 Do not switch on the monitor until all cables have been properly connected and verified.
 - 21 Do not touch the signal input or output connector and the patient simultaneously.
 - 22 Equipment and devices that connect to the monitor should form an equipotential body to ensure effective grounding.
 - 23 Disconnect the power cord before changing fuses. Replace them with those of the same specifications only.
 - 24 **SHOCK HAZARD** - Do not attempt to connect or disconnect a power cord with wet hands. Make certain that your hands are clean and dry before touching a power cord.
 - 25 **SHOCK HAZARD** - Do not remove the top panel cover during operation or while power is connected.
 - 26 Do not apply the monitor during electro-surgery or MRI; otherwise it might result in harming the patient or the operator.
 - 27 Only MECG, SpO2, NIBP and TEMP applied parts of the monitor are defibrillation-proof. When a defibrillator is applied, keep other accessories away from the patient. Otherwise it may result in damaging the monitor or harming the patient.
 - 28 Only connect accessories supplied or recommended by the manufacturer to the device.
 - 29 Accessory equipment connected to the analog and digital interfaces must be certified according to the respective IEC/EN standards (e.g. IEC/EN 60950 for data processing equipment and IEC/EN 60601-1 for medical equipment). Furthermore all configurations shall comply with the valid version of the system standard IEC/EN 60601-1-1. Anybody who connects additional equipment to the signal input connector or signal output connector to configure a medical system must ensure that the system complies with the requirements of the valid version of the system standard IEC/EN 60601-1-1. If in doubt, consult our technical service department or your local distributor.
-
-

WARNING

- 30 Parts and accessories used must meet the requirements of the applicable IEC 601 series safety standards, and/or the system configuration must meet the requirements of the IEC 60601-1-1 medical electrical systems standard.
- 31 Connect the grounding wire to the equipotential grounding terminal in the main system. If it is not evident from the instrument specifications whether a particular instrument combination is hazardous or not, for example due to summation of leakage currents, you should consult the manufacturer or an expert in the field, to ensure that the necessary safety of all instruments concerned will not be impaired by the proposed combination.

For proper monitoring:

- 32 Clinical decision making based on the output of the device is left to the discretion of the provider.
- 33 The disposable accessories are intended to be used only once. Dispose of them properly after use and do not reuse them.
- 34 The IUPC is neither intended nor approved for measuring intrauterine pressure extraovularly; attempting to do so may lead to maternal discomfort or injury.
- 35 Alarms must be set up according to different situations of patients. Make sure that audio sounds can be activated when an alarm occurs.
- 36 Do not put the sensor on extremities with arterial catheter or venous syringe.
- 37 Do not perform NIBP measurements on patients with sickle-cell disease or under any condition where the skin is damaged or expected to be damaged.
- 38 Do not apply the cuff to a limb that has an intravenous infusion or catheter in place. This could cause tissue damage around the catheter when infusion is slowed or blocked during cuff inflation.

For using the battery:

- 39 Before using the rechargeable lithium-ion battery (hereinafter called battery), be sure to read the user manual and safety precautions thoroughly.
 - 40 Unplug the monitor before installing and removing the battery.
 - 41 Do not short-circuit the battery by connecting the battery cable connector or battery socket with metal objects or solder.
 - 42 Do not connect the battery directly to an electric outlet or cigarette lighter charger.
 - 43 Do not heat or throw the battery into a fire.
 - 44 Do not use or leave battery close to fire or other places where temperatures may be above +60 °C (+140 °F).
 - 45 Do not immerse, throw or wet the battery in water/ seawater.
 - 46 Do not destroy the battery: Do not pierce battery with a sharp object such as a needle; Do not hit with a hammer, step on or throw or drop to cause strong shock; Do not disassemble or modify the battery.
-
-

WARNING

- 47 Use the battery only in the **F6** or **F6 Express** monitor.
 - 48 If the liquid leak from the battery gets into eyes, do not rub the eyes. Wash them well with clean water and see a doctor immediately.
 - 49 If the liquid leak from the battery spills onto your skin or clothes, wash well with fresh water immediately.
 - 50 Keep the battery away from fire immediately when leakage or foul odor is detected.
 - 51 Stop using the battery if abnormal heat, odor, discoloration, deformation or abnormal condition is detected during use, charge, or storage. Keep it away from the monitor.
 - 52 Do not use a battery with serious scar or deformation.
 - 53 Batteries have life cycles. If the time that the monitor using battery becomes much shorter than usual, the battery life is at an end. Replace the battery with a new one of the same specification as the one provided or recommended by the manufacturer.
 - 54 Remove the battery and store it at a cool and dry environment if the monitor is not used for a long time.
 - 55 If the battery is stored alone and not used for a long time, we recommend that the battery should be charged at least once every 6 months to prevent overdischarge.
-
-

CAUTION

- 1 Refer servicing to qualified personnel.
 - 2 Keep the environment clean. Avoid vibration. Keep it far from corrosive medicine, dust area, high-temperature and humid environment.
 - 3 When installing the unit into a cabinet, allow for adequate ventilation, accessibility for servicing, and room for adequate visualization and operation.
 - 4 Do not operate the unit if it is damp or wet because of condensation or spills. Avoid using the equipment immediately after moving it from a cold environment to a warm, humid location.
 - 5 Only the sensor and cable of US/TOCO transducers are watertight. Pay attention not let any liquid enter the transducer plug.
 - 6 Sterility can not be guaranteed if package of the fetal spiral electrode is broken or opened.
 - 7 The fetal spiral electrode has been sterilized by gamma radiation. Do not re-sterilize.
 - 8 Do not sterilize the monitor or any accessory with autoclave or gas.
 - 9 Switch off the system power before cleaning. Cleaning consists of removing all dust from the exterior surface of the equipment with a soft brush or cloth.
 - 10 **Electromagnetic Interference** - Ensure that the environment in which the monitor is installed is not subject to any source of strong electromagnetic interference, such as CT, radio transmitters, mobile phone base stations, etc.
-
-

CAUTION

- 11 Do not use mobile phones nearby in the process of monitoring.
- 12 The device and reusable accessories could be sent back to the manufacturer for recycling or proper disposal after their useful lives.
- 13 If the terminals of the battery become dirty, wipe with a dry cloth before using the battery.
- 14 For information on installing and removing the battery from the monitor, thoroughly read the user manual.
- 15 The device and accessories are to be disposed of according to local regulations after their useful lives. Alternatively, they can be returned to the dealer or the manufacturer for recycling or proper disposal.
- 16 The device and accessories are to be disposed of according to local regulations after their useful lives. Alternatively, they can be returned to the dealer or the manufacturer for recycling or proper disposal. Batteries are hazardous waste. Do NOT dispose them together with house-hold garbage. At the end of their life hand the batteries over to the applicable collection points for the recycling of waste batteries. For more detailed information about recycling of this product or battery, please contact your local Civic Office, or the shop where you purchased the product.

1.6 Definitions and Symbols

Socket for ultrasound transducer 1 (Type BF applied part)



Socket for ultrasound transducer 2 (Type BF applied part)



Socket for DECG cable (Type CF applied part)

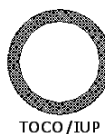











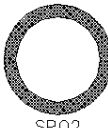
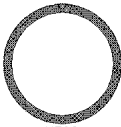
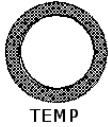

Socket for TOCO transducer or IUP cable (Type BF applied part)



Socket for Remote Event Marker (Type BF applied part)



Socket for Fetal Stimulator (Type BF applied part)

	Socket for NIBP Cuff (Type BF applied part)
	Socket for SpO ₂ Transducer (Type BF applied part)
	Socket for Maternal ECG Cable (Type CF applied part)
	Socket for TEMP Transducer (Type CF applied part)
	RS232 Interface (DB9 or D-Sub)
	RJ45 Interface
	Equipotential Grounding Terminal
	Charge Indicator
	Alternating Current (a.c.)
	Stand-by
	Caution
	Consult instructions for use
	Type BF Applied Part Symbol
	Type CF Applied Part Symbol
	The symbol indicates that the device complies with the European Council Directive 93/42/EEC concerning medical devices.
	The symbol indicates that the device should be sent to the special agencies according to local regulations for separate collection after its useful life.

P/N Part Number

SN Serial Number

 Date Of Manufacture

 Manufacturer

EC REP Authorized Representative in the European Community

 Recyclable

Rx only (U.S.) Federal (U.S.) Law restricts this device to sale by or on the order of a physician

Chapter 2 Installation Guide

NOTE:

Installation must be carried out by qualified personnel authorized by the manufacturer.

2.1 Opening and Checking Package

Visually examine the package prior to unpacking. If any signs of mishandling or damage are detected, contact the carrier to claim for damage.

Open the package; take out the monitor and accessories carefully. Keep the package for possible future transportation or storage. Check the components according to the packing list.

- ◆ Check for any mechanical damage.
- ◆ Check all the cables and accessories.

If there is any problem, contact us or your local distributor immediately.

2.2 Installing Battery

WARNING

Switch off the monitor and unplug it before installing or removing the battery.

If your monitor has been configured with a rechargeable lithium-ion battery, follow these steps to install the battery:

(1) Battery Installation

- 1) Carefully place the monitor upside down on a flat surface covered with cloth or other type of protecting pad.
- 2) Remove the screws of the battery compartment using a cross-head screw driver. Remove the battery compartment cover.



- 3) Take the battery out from package. Insert the cable connector into the socket.



- 4) Put the battery and the cables into the battery compartment.

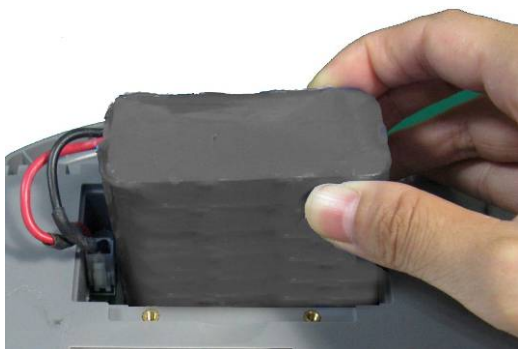

- 5) Shut the battery compartment cover and fix the screws.



(2) Battery Removal

Fold the LCD display completely flat before turning the monitor upside down. Remove the battery in reverse order.

NOTE:

- 1 If a rechargeable battery is outfitted, charge it fully each time after using the device to ensure the electric power is enough.
- 2 When the battery configuration is provided, after the device is transported or stored, the battery must be charged. Connecting to power supply will charge the battery no matter if the monitor is powered on.

2.3 Installing Monitor

The monitor can be placed on a flat surface, or be installed on a wall or a trolley. The service engineer should install the monitor properly.

2.4 Connecting Power Cable

- ◆ Make sure the AC power supply of the monitor complies with the following specification: 100V-240V~, 50Hz/60Hz.
- ◆ Apply the power cable provided with the monitor. Plug one end of the power cable to the power socket of the monitor. Connect the other end to a three-slot power output special for hospital usage.
- ◆ The equipotential grounding terminal is provided for the connection of a potential equalization conductor. Therefore, it is recommended to connect the grounding terminal of the monitor and the power outlet with the grounding wire, making sure the monitor is grounded.

WARNING

If the protective grounding (protective earth) system is doubtful, the power of the monitor must be supplied by inner power only.

NOTE:

- 1 Make sure the monitor and the power outlet are placed at a place where it is easy to connect and disconnect the power cord.
- 2 When the supply mains is interrupted, the device switches to inner power and operates normally if the battery is installed. If the battery is not installed, the monitor shuts down and resumes the previous settings at the subsequent operation.

Chapter 3 Monitor and Accessories

3.1 Overview

NOTE:

The pictures and interfaces in this manual are for reference only.

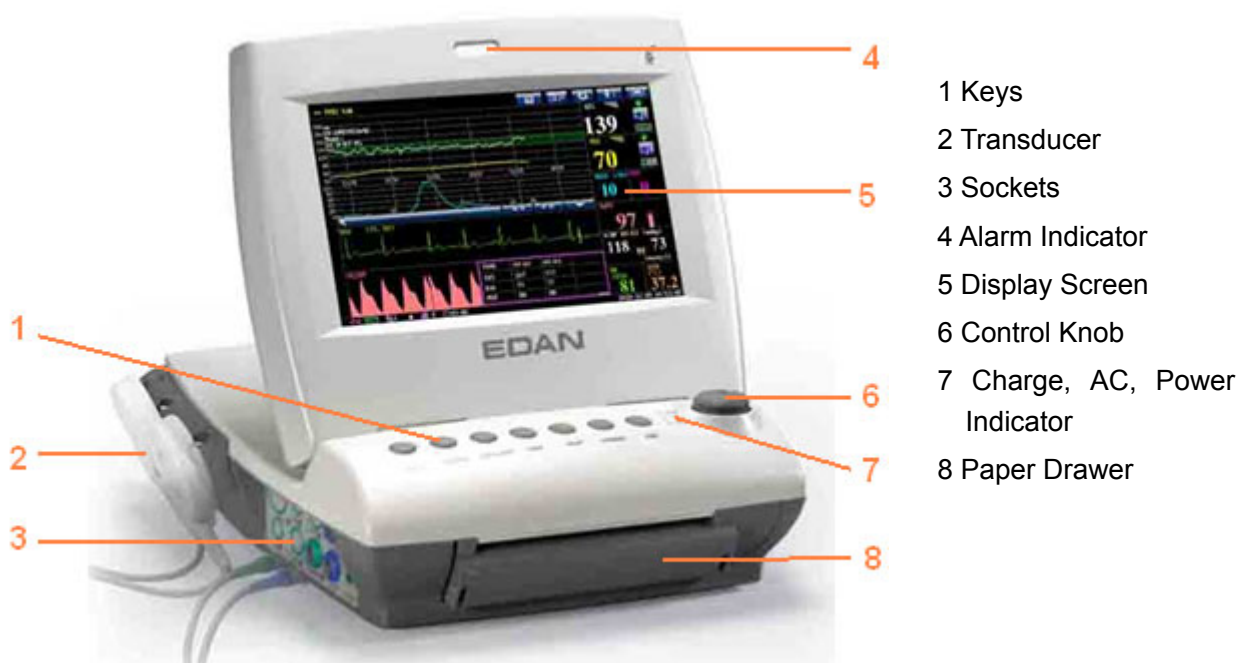

Figure 3-1 Appearance (for reference only)

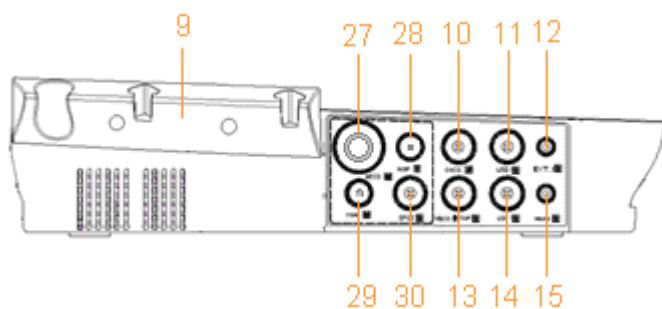

Figure 3-2 Left Panel

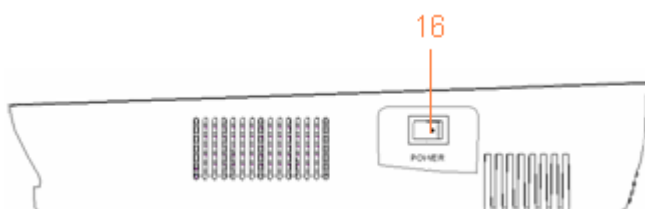
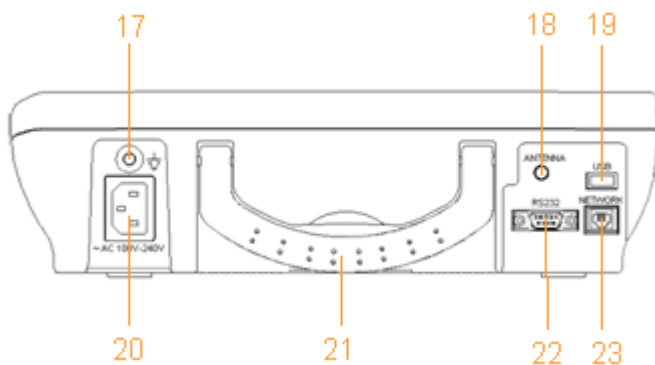

Figure 3-3 Right Panel

- 1 Keys
- 2 Transducer
- 3 Sockets
- 4 Alarm Indicator
- 5 Display Screen
- 6 Control Knob
- 7 Charge, AC, Power Indicator
- 8 Paper Drawer
- 9 Transducer Holder
- 10 DECG Socket
- 11 US2 Socket
- 12 EXT.1 Socket
- 13 TOCO/IUP Socket
- 14 US1 Socket
- 15 MARK Socket
- 27 MECG Socket
- 28 NIBP Socket
- 29 TEMP Socket
- 30 SpO2 Socket
- 16 POWER Switch



- 17 Equipotential Grounding Terminal
- 18 Antenna
- 19 USB Socket
- 20 Power Socket
- 21 Handle
- 22 DB9 Socket
- 23 RJ45Socket

Figure 3-4 Rear Panel

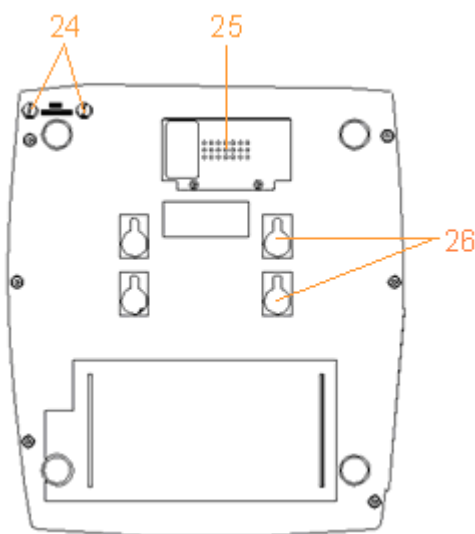

- 24 Fuses
- 25 Battery Compartment
- 26 Wall-mounting Holes

Figure 3-5 Bottom Panel

3.1.1 Keys and Control Knob

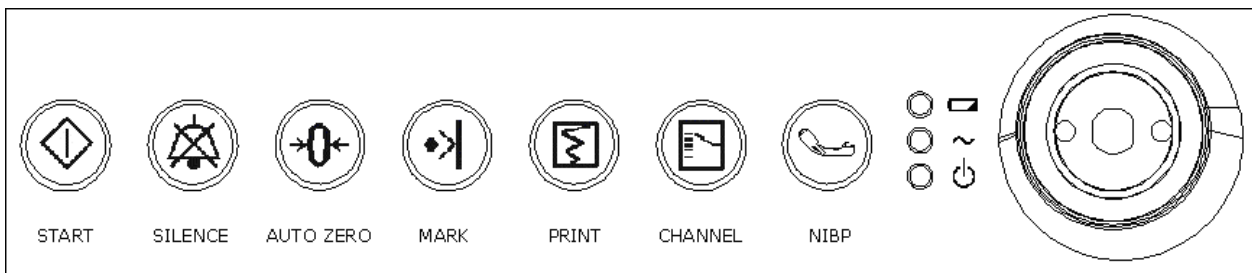

Figure 3-6 Keys and Control Knob

The Monitor is a user-friendly device with operation conducted by a few keys on the front panel and the control knob. Their functions are as follows:

(1) START

Function: Start monitoring or return to the main interface

Press this key to start monitoring (on the main interface) or return to main interface (in maternal information inputting menu or setup menus).

(2) SILENCE 

Function: Silence/reset

Press this key to disable the current auditory alarm manifestation, and re-enable the monitor's response to new abnormal patient condition.

(3) AUTO ZERO 

Function: TOCO zero

Adjust the external TOCO contractions trace/value to preset unit (external monitoring contractions) or the IUP trace/value to reference point 0 (internal monitoring contractions).

(4) MARK 

Function: Record an event.

Press this key to make an event mark.

(5) PRINT 

Function: Start / stop printing

Press this key to toggle between starting and stopping printing.

(6) CHANNEL 

Function: Switch the channels

Press this key to toggle the FH sound between US1 channel and US2 channel.

(7) NIBP 

Function: Start or stop a NIBP measurement.

Press this key to inflate the cuff and start a NIBP measurement. During the measuring process, press this key to cancel the measurement and deflate the cuff.

This function is only available on **F6 Express**.

(8) CONTROL KNOB

Function: Adjust volume, setup and review control.

It can be pressed like other keys and be rotated clockwise or counterclockwise. All the operations on the screen or in the menu are completed by using the control knob.

The highlighted rectangular mark on the screen that moves with the rotation of the control knob is called "cursor". Operations can be performed in the position on the screen where the cursor stays. When the cursor is located on a certain item, you can press the control knob to open its submenu

or confirm the operation. Press the control knob again, and the cursor will be able to move around on the interface/menus.

Operation Procedure:

- a) Rotate the control knob to move the cursor to the item you want;
- b) Press the control knob;
- c) One of the following three results will be achieved:
 - ◆ A menu pops up on the screen, or the menu is replaced by a new one;
 - ◆ A submenu with several options appears on the right of the item. If this item has more than 8 options, they will be displayed in more than one page. Select **PREV** to switch to the previous page, or select **NEXT** to switch to the next page.
 - ◆ The function operates immediately.



NOTE:



- 1 The word “select” hereinafter stands for rotating the control knob cursor to an item and then pressing the knob.
- 2 If the key sound is enabled, the monitor gives a normal key sound when the operation is valid, and gives a sharp “Di” sound when the operation is invalid.

CAUTION

This monitor is a normal medical device. Please avoid violent operations such as continuously pressing the keys or control knob.

3.1.2 Indicators

There are four groups of indicator on top of the screen and the front panel. From the top down they are: alarm indicator, CHARGE indicator, AC indicator and Power indicator.

Indicator		Status of Indicator	Meaning
	Alarm Indicator	Flash or light up in yellow	An alarm is active.
		Off	No alarm is active.
	Charge Indicator	On	The battery is being charged.
		Off	No battery or the battery is fully charged.
	AC Indicator	On	The monitor is connected to AC power supply.
		Off	The monitor is not connected to AC power supply.

	Power Indicator	On	The monitor is powered on.
		Off	The monitor is powered off.

3.2 Accessories

The accessories should be connected to the monitor via the sockets on the left side panel. Each accessory has a tab on the connector housing to ensure proper insertion into the appropriate socket on the monitor.

3.2.1 Ultrasound (US) Transducers

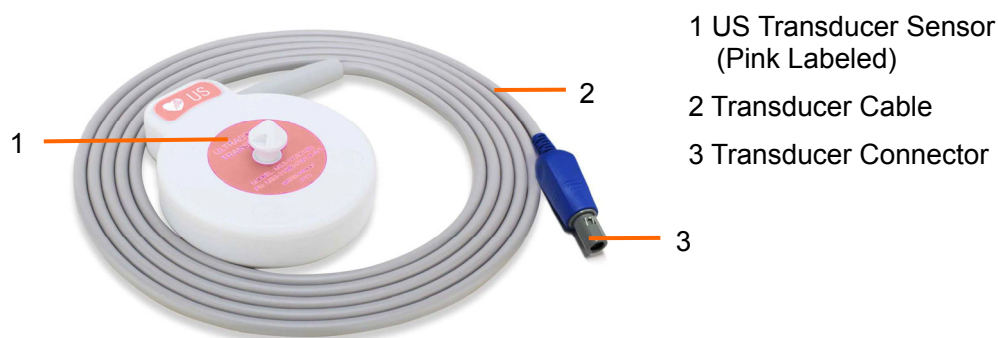

Figure 3-7 US Transducers

3.2.2 TOCO Transducers

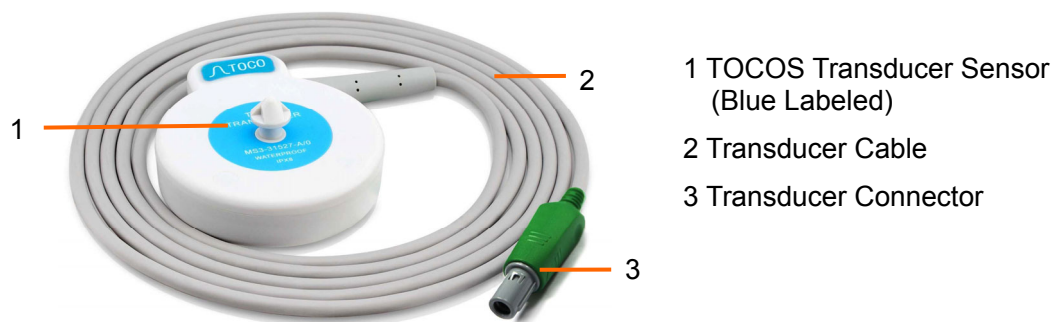

Figure 3-8 TOCO Transducers

3.2.3 Belt



Figure 3-9 Belt

3.2.4 Remote Event Marker



Figure 3-10 Remote Event Marker

3.2.5 Fetal Stimulator

FS-1 Fetal Stimulator is a hand-held device. In order to reduce the time required for the NST when the fetus is asleep, it can be used to give a mild vibrating stimulation to the fetus through the maternal abdomen.

During NST, the vibrating operation marks can be displayed /printed on CTG trace when the fetal stimulator is connected to the monitor by an audio cable.

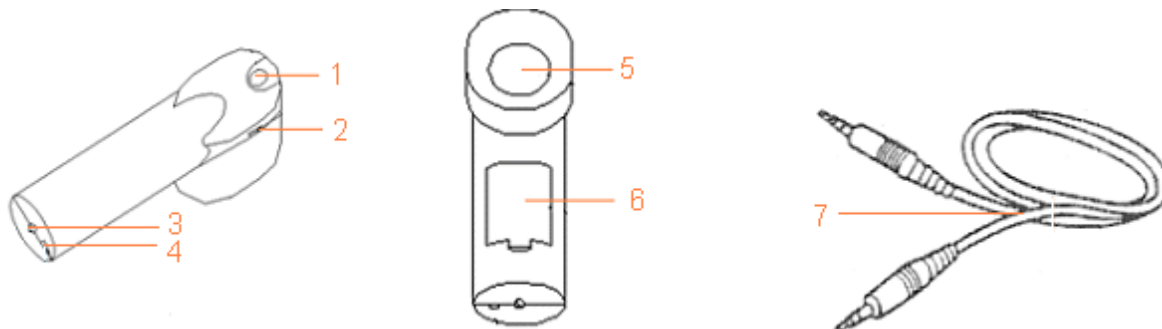

Figure 3-11 Fetal Stimulator

- | | | | |
|---|------------------|---|----------------------------------|
| 1 | Operating Switch | 2 | Vibration Rhythm Adjusting Wheel |
| 3 | Marker Socket | 4 | Mode Selecting Switch |
| 5 | Vibrating Head | 6 | Battery Compartment |
| 7 | Audio Cable | | |

3.2.6 DECG Cable

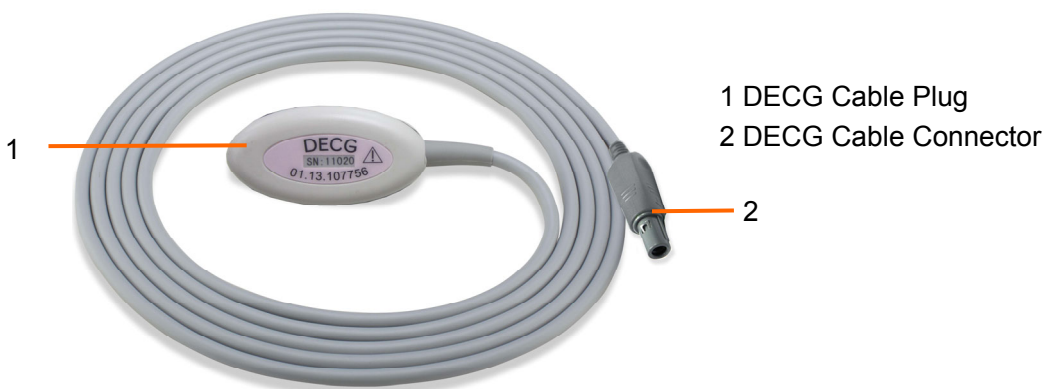

Figure 3-12 DECG Cable

3.2.7 Fetal Spiral Electrode

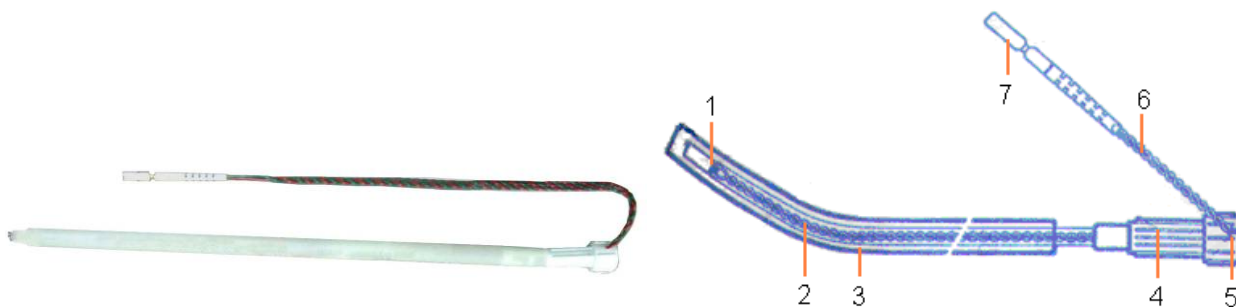

Figure 3-13 Fetal Spiral Electrode

- | | | | | | | | |
|---|---------------------|---|----------------|---|------------|---|--------------|
| 1 | Reference Electrode | 2 | Drive Tube | 3 | Guide Tube | 4 | Drive Handle |
| 5 | Handle Notch | 6 | Electrode Wire | 7 | Safety Cap | | |

3.2.8 IUP Cable



Figure 3-14 IUP Connecting Cable

1 Interface to IUP Cable

2 Connecting plug



Figure 3-15 IUP Cable

3 Interface to IUP Catheter

4 Interface to Connecting Cable

3.2.9 IUP Catheter

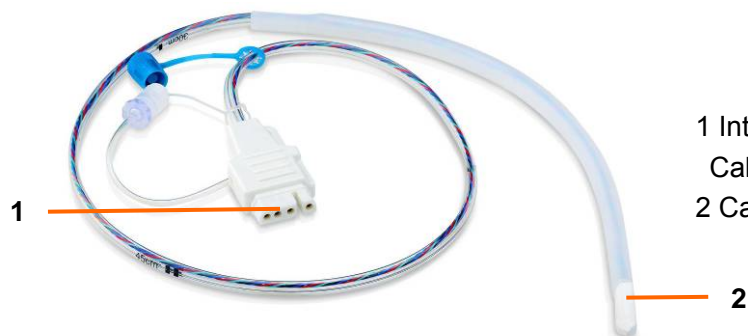

Figure 3-16 IUP Catheter

1 Interface to Connecting Cable

2 Catheter

3.2.10 ECG Cable



Figure 3-17 3-Lead ECG Cable

1 ECG Connector

2 ECG Fastener

3 Lead Wire

3.2.11 SpO₂ Transducer

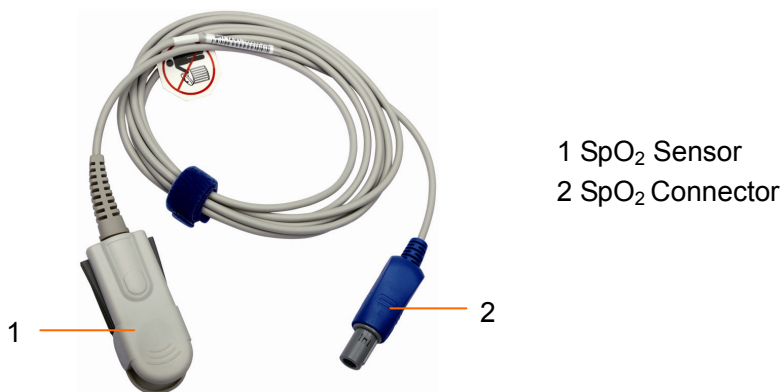

Figure 3-18 SpO₂ Transducer

3.2.12 NIBP Cuff



Figure 3-19 NIBP Cuff



1 NIBP Cuff
2 Cuff Extension Tube

Figure 3-20 Cuff Extension Tube

3.2.13 TEMP Transducer



Figure 3-21 TEMP Transducer

3.3 Screen

3.3.1 Main Interface



Figure 3-22 Main Interface

The main interface of the monitor displays numbers, traces, menus and monitor status information. The screen background color has four choices: black (default), green, orange and blue.

To change the screen color,





- 1 Select the setup key  on the main interface.
- 2 Select **General > Screen Color**.
- 3 Select the required color.
- 4 Select **OK**.

According to the content, the main interface is divided into four windows: (1) Message Window (2) Trace/ Menu Window (3) Numeric Window (4) Status Window.

(1) Message Window



- a) **Alarm messages displaying area.** When an alarm is active, the message will be displayed here in yellow. Patient alarms will be displayed on the left and technical alarms in the center.

- b) : **Alarm reviewing key.** Select this key to open the alarm reviewing menu.
- c) : **Paper advancing key.** Select this key to advance the paper for 8 cm (PHILIPS paper) or 7 cm (GE paper).
- d) : **Display mode switch.** F6 Express monitor has three display modes: maternal-fetal display mode, fetal display mode and maternal display mode. Select this key, and the display mode will switch to the next one in order.
- e) : **Mat. Info key.** Select this key to open maternal information menu for inputting or changing the patient’s ID and name.
- f) : **Setup key.** Select this key to open setup main menu.

(2) Trace/Menu Window

The trace/menu window occupies most space of the screen. During monitoring or reviewing, it displays traces; during setting, it displays setup menus.

The background pane bar supports two standards: 30 ~ 240 (American standard) and 50 ~ 210 (International standard).

The green band in between the fetal heart rate panes indicates the preset alarm range (the top edge is not higher than 180 and the bottom edge is not lower than 100). It makes it easy to observe if the FHR exceeds the normal range. So you can easily tell if the fetal heart rate is too low or too high.

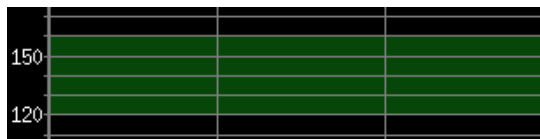



(3) Numeric Window

The fetal monitoring numerics are displayed here.

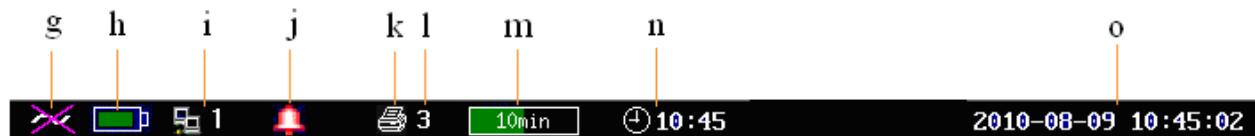
(4) Status Window



- g) Power indicator
 -  - AC power supplied.
 -  - no AC power supplied.
- h) Battery indicator
 -  - battery is loaded; the green pane indicates the charge of the battery.

 - no battery is loaded.

i) Network connection indicator and device no.

 - the monitor is online.

 - the monitor is offline.

NOTE: The network connection indicator is not available if the net version is Insight or Philips.

j) Audio alarm indicator

 - the audible alarm is switched on.

 - the audible alarm is switched off infinitely.

 - the audible alarm is switched off temporarily.

k) Recorder status indicator

 - the recorder is in the process of printing.

 - no printing is going on.

l)  - Print speed.

m)  - Print remaining time.

n)  10:45 - Monitoring timer. It indicates the duration of the current monitoring, and zeroes when the **START** key is pressed.

o) The date and time of the monitor.

3.3.2 Setup Interface

The setup menu is provided to change the monitor configurations and monitoring settings. Press the Setup key  on the main interface to open this menu.



Figure 3-23 Main Setup Menu (F6)

In the setup main menu, you have access to all the items other than **System**. You can select **EXIT**

to exit from this menu.

The items in this main menu all have submenu(s). To confirm the setting changes in the submenus, you need to select **OK** to exit. If you don't want to store the new settings, select **Cancel**, or press the **START** key to return to the main interface. If no operation is performed in 30 seconds, the menu will return to the upper directory. The change will not be stored.

Once you select **OK** to confirm the setting changes, the new settings will be stored in the monitor's long-term memory. If the monitor is switched on again after being switched off or a power loss, it will restore the new settings. The setting does not take effect if the system exits automatically or is shutdown before **OK** is selected.

For your reference, when the cursor is located at an item in this menu, the monitor provides a brief function description of this item in a pane with blue frame under the items. For example, the cursor is located at "System" in the illustration above. Correspondingly, its function "Set system items of the monitor" is issued in the blue frame pane.

3.4 Ordering Information

Accessories (standard and optional configuration) supplied or approved by the manufacturer can be used with the monitors. See the following table for details.

Accessory (Spare Part)	Part Number
Ultrasound Transducer	12.01.109301
TOCO Transducer	12.01.31527
Remote Event Marker	02.01.210095
Belt	11.57.02264
Aquasonic Coupling Gel (0.25ltr bottle)	11.57.78008
Fetal Stimulator	03.27.17660
DECG Cable	01.13.036358
Disposable Fetal Spiral Electrode	11.57.02145
Disposable Attachment Pad Electrode	11.57.02146
IUP Cable	11.13.104152
IUP Connecting Cable	01.13.036357
Disposable Intrauterine Pressure Catheter	11.57.104153
3-lead ECG Cable (Snap style, IEC)	01.57.471099

3-lead ECG Cable (Snap style, AHA)	01.57.471087
3-lead ECG Cable (Grabber style, IEC)	01.57.471098
3-lead ECG Cable (Grabber style, AHA)	01.57.471095
Disposable ECG Electrode (FDA)	11.57.471060
Disposable ECG Electrode (CE)	11.57.471056
SpO ₂ Transducer	12.01.109069
NIBP Cuff (Upper Arm Perimeter 25cm-35cm, for Adult)	01.57.40029
NIBP Cuff Extension Tube	01.59.036118
TEMP Transducer	01.15.040187
Thermosensitive Paper (GE-American)	01.57.75111
Thermosensitive Paper (GE-International)	01.57.75112
Thermosensitive Paper (Philips-American)	01.57.75113
Thermosensitive Paper (Philips-International)	01.57.75114
Power Cord (European Standard)	01.13.36014
Power Cord (American Standard)	11.13.36015
Fuse T2AH250V	21.21.064181
Rechargeable Lithium-ion Battery	21.21.064150
Signal Cable	01.13.036299
Y-shaped Signal Cable	01.13.036301

The accessories employed by the manufacturer, such as the rechargeable battery, are products having passed the authentication of CE, and they have the characteristics specified by their manufacturers. The materials with which the patient or any other person can come into contact conform with the standard of ISO 10993.

CAUTION

Replacement of all above accessories can be performed by the operator. But only the accessories supplied or recommended by the manufacturer are allowed connected to the monitor.

Chapter 4 Alarms

4.1 Alarm Classification

The monitor has two types of alarm: patient alarm and technical alarm.

Patient alarms indicate the situation of vital sign exceeding its configured limit. They can be disabled. The adjustable alarm limits determine the conditions that trigger the alarm.

Technical alarms indicate that the monitor can not measure and therefore can not detect critical patient conditions reliably. They cannot be disabled.

In terms of severity, the alarms are divided into three levels: high, medium and low. High level alarm indicates the condition where the patient's life is endangered; it is a severe warning, labeled with the symbol ***; Medium level alarm is a moderate warning, labeled with the symbol **; low level alarm is a general warning.

The high level alarms have highest priority, and the medium level alarms take the second place. If more than one type of alarms is active at the same time, the monitor sounds an audible indicator for the higher level alarms.

The alarm levels are preset, and you can not change them.

4.2 Audible Alarm

If the audible alarm is not disabled, the alarm indicator displays . When an alarm is active, the monitor gives out a sound. (The sound pressure range is 45dB ~ 85dB.)

High level alarm: a “Do” tone is repeated three times, and then pauses for 3 seconds.

Medium level alarm: a “Do” tone is repeated three times, and then pauses for 4 seconds.

Low level alarm: a “Do” tone is issued, and then pauses for 20 seconds.

Press the **SILENCE** key, the current audible alarm toggles between on and off (temporarily or infinitely, you can change the setting).

If the current audible alarm is temporarily disabled, the alarm indicator displays , with a remaining time on the right. When the time is out, or when other alarms present, the monitor enables the audible alarm automatically.

If the current audible alarm is infinitely disabled, the alarm indicator displays  (flashing). The audible alarm is enabled again when the **SILENCE** key is pressed, or when other alarms present.

During the silence period, the alarm messages are displayed and the alarm indicator lights up as usual. You can press the **SILENCE** key again to enable the audio alarm.

4.3 Visual Alarm

When an alarm is active,

- **Alarm indicator:** the alarm indicator lights up:

Alarm Category	Indicator Color	Flashing Frequency	Duty Cycle
High level alarm	red	1.4Hz to 2.8Hz	20% to 60% on
Medium level alarm	yellow	0.4Hz to 0.8Hz	20% to 60% on
Low level alarm	yellow	Constant (on)	100% on

- **Alarm message:** the alarm message appears in the message window of the main interface in yellow, with patient alarms on the left and technical alarms in the middle.

- **Flashing numeric:** the numeric of the measurement flashes in grey with a frequency of 2Hz.

When more than one alarm is active, the alarm messages appear in the same area in succession.

The patient alarm messages are displayed either:

- ◆ in text form, for example “** FHR2 LOW”; or
- ◆ in numeric form, for example “** FHR2 115 < 120”; ** indicates this is a medium level alarm event; the first number is the current measurement result; the second number is the preset alarm limit.

The technical alarm messages are displayed in text form, for example “Fetus EQUIP MALF”.

4.4 Choosing Alarm Display Form

You can change the patient alarm display form,

- 1 Select the setup key  on the main interface.
- 2 Select **Alarm > Message Form**.
- 3 Select **Text** (default) or **Numeric**.
- 4 Select **OK**.

4.5 Changing Alarm Volume

You can change the alarm volume,

- 1 Select the setup key  on the main interface.
- 2 Select **Alarm > Alarm Volume**.
- 3 Select **Low** (default), **Medium** or **High**.
- 4 Select **OK**.

4.6 Choosing Alarm Silence Duration

You can change the alarm silence duration,

- 1 Select the setup key  on the main interface.
- 2 Select **Alarm > Silence Duration**.
- 3 Select **Infinite** (default), **1 min**, **2 min** or **3 min**.
- 4 Select **OK**.

4.7 Choosing Signal Loss Delay

When the fetal signal is lost and this condition continues for a certain time, the monitor issues a technical alarm. This time (signal loss delay) is adjustable. To change the signal loss delay,

- 1 Select the setup key  on the main interface.
- 2 Select **Alarm > Signal Loss Delay**.
- 3 Select **0** (default) ~ **300** seconds.
- 4 Select **OK**.

4.8 Reviewing Alarms

An alarm reviewing menu records a list of up to 50 of the most recent patient and technical alarm messages with date and time information.

Select the alarm reviewing key  in the message window to open this menu.

Each page displays 10 alarm records. The page mark “1/5” informs you that there are 5 pages and the present one is page 1.

To review more records, select the alarm list and then rotate the control knob to switch to the previous or next page.

Select **OK** to exit from this menu.

When a new monitoring starts, or after the monitor is switched off, the alarm messages will be cleared.

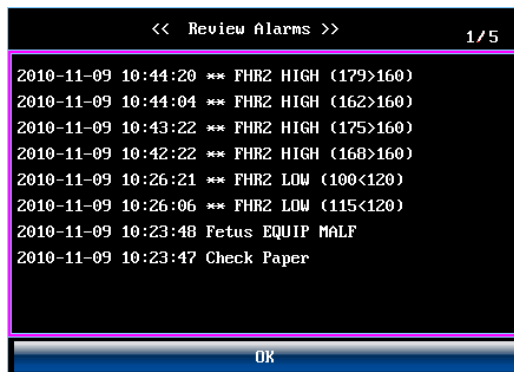

4.9 Alarm Treatment Measures

During monitoring, make sure there is at least one physician in the area where the alarm sound can be heard or the alarm messages can be seen, so necessary measures can be taken when an emergency occurs.

When the monitor gives out an alarm and catches your attention, you should:

- Check the patient's condition.
- Identify the cause of the alarm.
- Silence the alarm if necessary.
- Check if the alarm is terminated when the alarm condition is solved.

When the monitored parameter(s) come(s) back within the adjusted limits, or if the abnormal technical condition does not exist any longer, the monitor stops giving out the alarm.

4.10 Testing Alarms

To test the functions of visible and audible alarms, do the following:

- 1 Switch on the monitor.
- 2 Enable the alarm.
- 3 Set the alarm limits to a small range.
- 4 Stimulate a signal that is higher than the upper limit or lower than the lower limit. Or disconnect one of the plugs.
- 5 Verify if the visible and audible alarms are working properly.

4.11 Patient Alarm Defaults

Alarm Setting	Options	Default
ASYSTOLE	On (not adjustable)	On
Asystole Alarm Delay	0 second (not adjustable)	0 second
Asystole Alarm Level	High (not adjustable)	High
FHR Alarm	On, Off	On
FHR Low Alarm Limit	60 bpm ~ 205 bpm, in increments of 5	120 bpm
FHR High Alarm Limit	65 bpm ~ 210 bpm, in increments of 5	160 bpm
FHR Alarm Delay	0 ~ 300 second(s), in increments of 5	10 seconds
FHR Alarm Level	Medium, not adjustable	Medium
HR Alarm	On, Off	On
HR Low Alarm Limit	30 bpm ~ 239 bpm, in increments of 1	50 bpm
HR High Alarm Limit	31 bpm ~ 240 bpm, in increments of 1	120 bpm
HR Alarm Delay	0 second, not adjustable	0 second
HR Alarm Level	Medium, not adjustable	Medium

SpO ₂ Alarm	On, Off	On
SpO ₂ Low Alarm Limit	50% ~ 99%, in increments of 1	90%
SpO ₂ High Alarm Limit	51% ~ 100%, in increments of 1	100%
SpO ₂ Alarm Delay	0 second, not adjustable	0 second
SpO ₂ Alarm Level	Medium, not adjustable	Medium
SYS Alarm	On, Off	On
SYS Low Alarm Limit	30 mmHg ~ 269 mmHg, in increments of 1	90 mmHg
SYS High Alarm Limit	31 mmHg ~ 270 mmHg, in increments of 1	160 mmHg
SYS Alarm Delay	0 second, not adjustable	0 second
SYS Alarm Level	Medium, not adjustable	Medium
DIA Alarm	On, Off	On
DIA Low Alarm Limit	10 mmHg ~ 244 mmHg, in increments of 1	50 mmHg
DIA High Alarm Limit	11 mmHg ~ 245 mmHg, in increments of 1	90 mmHg
DIA Alarm Delay	0 second, not adjustable	0 second
DIA Alarm Level	Medium, not adjustable	Medium
TEMP Alarm	On, Off	On
TEMP Low Alarm Limit	0 °C ~ +49.9 °C, in increments of 0.1	+36.0 °C
TEMP High Alarm Limit	+0.1 °C ~ +50.0 °C, in increments of 0.1	+39.0 °C
TEMP Alarm Delay	0 second, not adjustable	0 second
TEMP Alarm Level	Medium, not adjustable	Medium

NOTE:

The upper limit must be higher than the lower limit. When setting the upper limit, you do not have access to the options that are lower than the preset lower limit, and vice versa.

Chapter 5 Printing

5.1 Function Description

The built-in thermal recorder applied in the monitor supports both the American and international standard wide recorder paper. It prints continuous traces synchronously along with marks.

The monitor supports some other functions listed below:

- ◆ **Auto start printing:** If the function is enabled, the recorder starts printing automatically when new monitoring starts (the **START** key is pressed). Otherwise you have to press the **PRINT** key to start printing.
- ◆ **Printing timer:** The printing timer determines the elapsed time for each print. This time is adjustable. Refer to 5.2.3 *Changing the Print Timer*.
- ◆ **Remaining time indicating:** If the printing timer is set, a process indicator  appears in the status window after printing starts, with the remaining time shown in it. When the time is up, the monitor gives three “Do” tones and flashes the indicator.
- ◆ **Fast printing:** The recorder prints the data saved in the monitor at a high speed (up to 25mm/s).
- ◆ **Data Caching:** When the paper drawer runs out of paper or when it is open, the recorder stops printing. The data from this time on (at most 60 minutes) will be temporarily saved in the internal memory. When new paper is loaded and/or the drawer is closed, the saved data will be printed out at a high speed. When the saved trace has been printed out, the recorder switches back to continue printing the current data at the normal speed automatically.

NOTE:

- 1 When the monitor is switched off, the data in the internal memory will be lost.
 - 2 If a printing timer is set, and the time is out when the paper runs out, the CTG analysis result may disaccord with the printout. Therefore, reload the paper in time to avoid paper lack.
- ◆ **FHR2 offset:** You can set the offset of the FHR2 trace to separate the two FH traces on the screen and the recorder paper. Refer to 7.4.4 *Changing FHR2/DFHR Offset*.
 - ◆ **Print self-check:** The recorder prints a baseline for self checking when the monitor is switched on.
 - ◆ **Paper advance:** When printing stops, press the paper advancing key  to advance the paper, making sure the paper has a perforation outside the drawer and is easy to be torn off.

NOTE:

The paper advancing key is invalid in the process of printing and paper advancing.

5.2 Printing Configuration

NOTE:

All the parameters should be well configured before printing starts. You can not change the configuration in the process of printing.

5.2.1 Switching Auto Start Printing On or Off

You can switch auto start printing on or off:

- 1 Select the setup key  on the main interface.
- 2 Select **Start Monitoring > PRINT**.
- 3 Select **ON** or **OFF** (default).
- 4 Select **OK**.

5.2.2 Choosing Paper Speed

You can choose a paper speed of 1 cm/min, 2cm/min or 3cm/min:

- 1 Select the setup key  on the main interface.
- 2 Select **Recorder > Print Speed**.
- 3 Select **1 cm/min**, **2 cm/min** or **3 cm/min** (default).
- 4 Select **OK**.

NOTE:

Different paper speed setting causes different FHR trace appearance on the record paper. To avoid misinterpretation, we recommend you to set all monitors in your institution to the same paper speed.

5.2.3 Changing Print Timer

You can choose different time lengths for the print timer:

- 1 Select the setup key  on the main interface.
- 2 Select **Recorder > Timer**.
- 3 Set timer to **10 ~ 90** (minutes, the step is 5) or **Infinite**. For a fixed time, the recorder stops when the time is up. For **Infinite**, there is no time limit. Whatever the setting is, the recorder stops when this patient's traces come to the end or if the **PRINT** key is pressed in midway.
- 4 Select **OK**.

5.2.4 Switching Print Self-Check On or Off

You can switch on or off the print self-check feature:

- 1 Select the setup key  on the main interface.
- 2 Select **Recorder > Print Self-Check**.
- 3 Select **ON** or **OFF** (default).
- 4 Select **OK**.

5.2.5 Changing Printing End Volume

The monitor gives a tone when printing ends, and this tone volume is adjustable.

- 1 Select the setup key  on the main interface.
- 2 Select **Recorder > Printing End**.
- 3 Select **High, Low** (default) or **OFF**.
- 4 Select **OK**.

5.3 Understanding Recorder Paper Printout

WARNING

- 1 If there is any discrepancy between the display and the printout, the printout should prevail.
- 2 If the data is doubtful, clinicians should make diagnoses based on the real condition.

Figure 5-1 is an example of the recorder paper with traces. Comparing it with the monitor screen, you can find this extra information on it:



Figure 5-1 An example of recorder paper with traces

Item	Information	Description
1.	Self-Check Trace	The monitor prints a self-check trace after being switched on. It is used to check if the recorder paper is properly loaded.
2.	Paper Settings	The paper settings of the monitor. It consists of the paper type and paper style, e.g. "G 50-210", indicating that the paper type is "F9-G", and the paper style is International.
3.	Paper Type	There are two types of paper: F9-G and F9-P.
4.	Paper Style	The FHR pane range indicates the paper style. American style: 30 ~ 240 International style: 50 ~ 210
5.	FHR1 Mark	The trace marked with "FHR1" is the FHR1 trace.
6.	FHR2 Mark	The trace marked with "FHR2" is the FHR2 trace.
7.	Trace Information List	A list of current date, time, print speed, ID, FHR2 offset, HR, SpO ₂ , and TEMP is printed at the start of the monitoring and every ten minutes afterwards. In the NIBP timer printing mode, the list also includes SYS, DIA and MAP.
8.	Smart Note	The annotation of the event mark below.
9.	HR Mark	The trace marked with "HR" is the maternal HR trace.
10.	SpO ₂ Mark	The trace marked with "SpO ₂ " is the maternal SpO ₂ trace.
11.	NIBP	In the NIBP real-time printing mode, each NIBP measurement result is printed on the paper in the order of SYS/DIA/MAP.
12.	Page Mark	Each recorder paper pack has 150 pages. When you notice the page mark comes to the end, remember to load new paper in time.
13.	CTG Analysis Result	The CTG analysis results of FHR1 and FHR2.

Chapter 6 Pre-Monitoring Preparation

6.1 Loading Recorder paper

CAUTION

- 1 Only use the recorder paper provided by the manufacturer, otherwise the recorder may be damaged. This kind of damage is not covered by warranty.
- 2 Configured with different hardware, the monitor is compatible with both GE and Philips recorder paper. However, the monitor is configured with only one type of paper in the shipment. If you want to use the other type of paper, contact the manufacturer for service first, otherwise trace excursion or paper jam may occur.

If the monitor is used for the first time or when the paper runs out, you should load paper.

- 1) Press the two latches on each side of the paper drawer at the same time and slide the drawer out carefully.



- 2) Take out the Z-fold thermosensitive paper and remove the wrapper.
- 3) Place the pack in the drawer, with the pane facing up and the FHR trace area on the left.

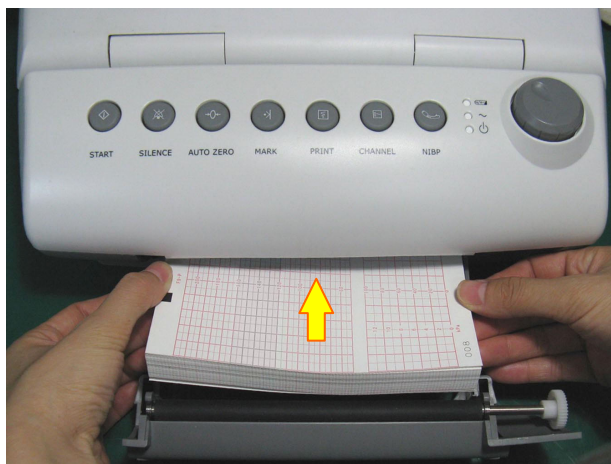

- 4) Unfold two sheets from the top of the pack and pull the end of the paper out of the drawer (make sure the pack in the drawer remains flat).
- 5) Slide the drawer in until both the latches are locked.

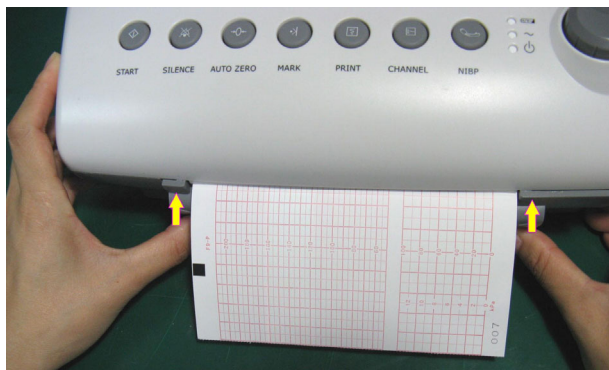
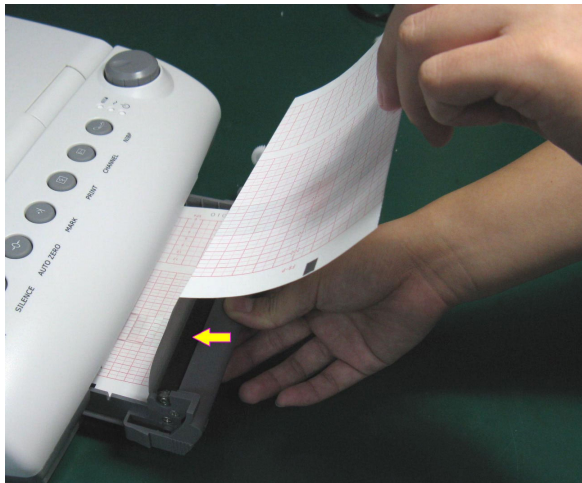
**NOTE:**

- 1 Be careful when inserting paper. Avoid damaging the thermosensitive print head.
- 2 Make sure the paper is evenly loaded in the drawer. Otherwise the data will be inaccurate or paper jam will happen.
- 3 Only use the paper the manufacturer approved to avoid poor printing quality, deflection, or paper jam.
- 4 Keep the drawer closed unless when loading paper or providing a service.

Removing Paper Jam

When the recorder does not function or sound properly, open the drawer to check for a paper jam. Remove the paper jam in this way:

- 1) Cut the recorder paper from the paper drawer edge.
- 2) Through the hole on the bottom panel of the paper drawer, push the recorder paper up with one finger. Remove the paper.
- 3) Reload paper and then close the drawer.



6.2 Switching On

WARNING

- 1 Check if all the metal parts are linked to the protective earth cord and the cord is in good condition before switching on the monitor.
- 2 If any sign of damage is detected, or the monitor displays some error messages, do not use it on any patient. Contact biomedical engineer in the hospital or our service engineer immediately.

Press the **POWER** switch on the right panel to switch on the monitor. The power indicator lights up and a start-up music will be heard. You can operate the monitor after the main interface appears.

You can choose to switch the start-up music on or off,

- 1 Select the setup key  on the main interface.
- 2 Select **General > Start-up Music**.
- 3 Select **ON** (default) or **OFF**.
- 4 Select **OK**.

6.3 Checking Recorder Paper

The monitor provides the print self-check function to check if the recorder paper is correctly loaded and set.

The recorder prints a baseline and paper settings after start-up (if **Print Self-Check** is **ON**).

Check if the paper settings match the paper being used (in the circled area below, **P** should correspond to **F9-P**, and **G** to **F9-G**), and then observe the starts and ends of the printed baselines (illustrated with the arrow). The starts and ends should be printed exactly on the edges of the pane if the recorder paper is correctly loaded and set. If they do not comply with the edges, reload paper or ask the service engineer to check the paper settings of the monitor.

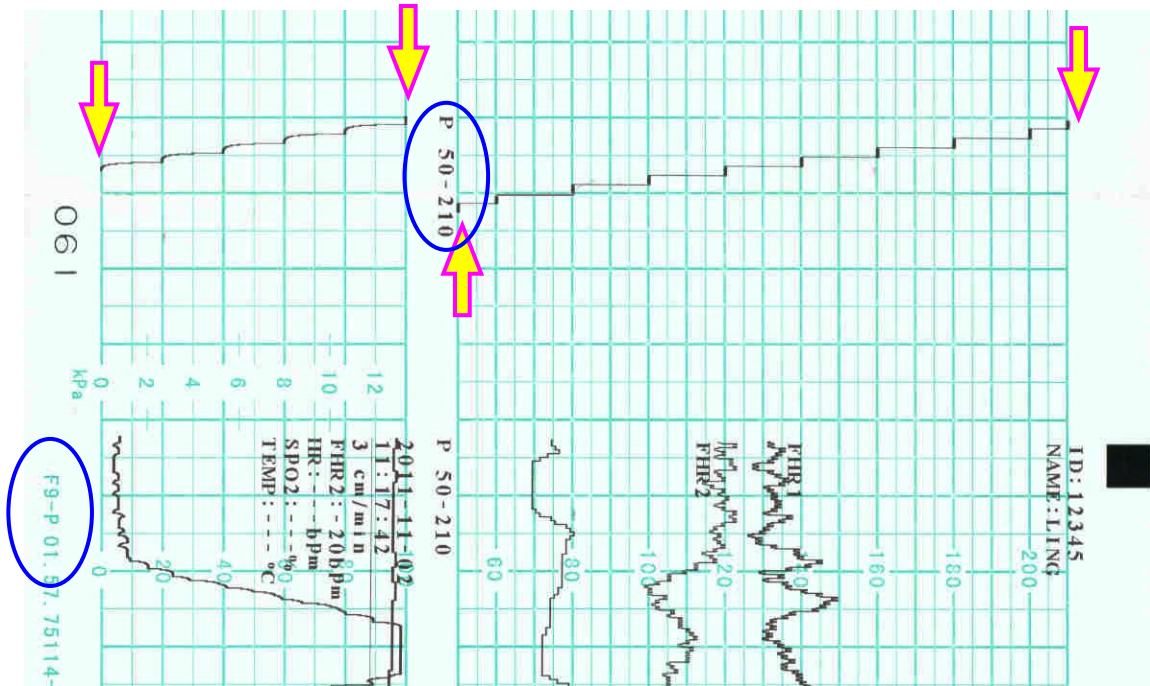

If the monitor does not print the baseline, switch on the **Print Self-Check** function and then restart the monitor.

NOTE:

Make sure the paper is correctly loaded before the printing starts.

6.4 Adjusting Screen Angle

The angle between the screen and the top cover of the monitor is adjustable as needed, allowing it to be mounted on a wall or placed on a flat surface.

Adjustment method:

Push the hook on top of the screen left to spring it open. Pull the screen forward to adjust to one of the preset screen angles.



To bring the screen back to flat, pull it all the way forward and then push it back.



6.5 Setting Date and Time

You can change the date and time of the monitor,

- 1 Select the setup key  on the main interface.
- 2 Select **Date and Time**.
- 3 Set the year, month, date, hour, minute and second. The first three numbers are used to set the year, month and date. Their orders vary with the preset Date Format below.
- 4 Select **Date Format** for the format of the date; there are three options: yyyy-mm-dd (default), mm/dd/yyyy and dd/mm/yyyy.
- 5 Select **OK**.

CAUTION

You should set date and time information in advance. After this information is changed, the monitor starts new monitoring with an auto ID. Therefore, we advise you to restart the monitor after changing date or time information, and do not perform this operation when monitoring is in process.

NOTE:

The date and time remain in the monitor for at least two months after it is switched off. You do not have to set date and time before monitoring each time.

6.6 Connecting Transducers

Check for visible damages of the transducers every time before connecting them to the monitor. Pay special attention to the cracks on the transducers and cables before immersing them into conductive fluid. If damage is found, replace them with good ones at once.

When plugging transducers into the monitor, make sure the arrow symbol of the connector faces up and put it into the socket.



When disconnecting a transducer, pinch the afterbody of the transducer plug and pull it out slightly.

NOTE:

Never try to disconnect the transducer by pulling the cable directly.

6.7 Placing Accessories in the Holder

In order to protect the accessories, place the not-in-use accessories in the holder. The accessory holder is on the left of the front panel. The first hole from the top is for the remote event marker, and the rest two are for the transducers.

To place a transducer into the holder, hold the transducer on the edge, and then place the buckle all the way into one of the holes on the holder. Make sure that the transducer cable is on the bottom.

To place the remote event marker, put the small end of the marker into the hole as far as it can go.



NOTE:

In the process of monitoring, the transducer that is placed in the holder may be affected

and thereby produces interfering signals. Therefore, when monitoring a patient, it is recommended to remove or disconnect the transducer that is not in use.

6.8 Adjusting Volume

The monitor automatically detects which channel the ultrasound transducer is connected to. The corresponding volume adjustment key of this channel displays , indicating the FH sound is

coming out from this channel, for example: ; while the other one displays , for

example: . Press the **CHANNEL** key to switch the FH sound to the other channel.



Adjust the default monitoring volume:

The FH volume returns to the default level after the **START** key is pressed. This default level is adjustable. To change this level,

- 1 Select the setup key  on the main interface.
- 2 Select **Start Monitoring > Volume**.
- 3 Select the volume from 1 ~ 10; the step is 1 and the default level is 3.
- 4 Select **OK**.

Adjust the real-time monitoring volume:

If the default volume level is not satisfactory during monitoring, you can adjust the real-time volume of each channel.

- 1 Select the volume adjustment key  on the main interface.
- 2 Rotate the control knob clockwise for one step, the volume increases by one level, there are ten levels for your choice; the green pane of the volume level indicator  increases by one at every two steps; rotate the knob anticlockwise to decrease the volume.
- 3 Press the knob again to confirm the volume level.

Adjust the key volume:

The volumes of pressing keys, rotating and pressing the control knob are also adjustable.

- 1 Select the setup key  on the main interface.
- 2 Select **General > Key Volume**.
- 3 Select **Low** (default), **High** or **OFF**.
- 4 Select **OK**.

Chapter 7 Fetal Monitoring

WARNING

- 1 The monitor is not intended for use in intensive care units (ICU), operating rooms or for home use.
 - 2 Do not apply it during electro-surgery or MRI; otherwise it might result in harming the patient or the operator.
 - 3 Always check if the alarm settings are appropriate for your patient before starting monitoring.
-

7.1 Confirming Fetal Life

Fetal monitoring with ultrasound or DECG can not differentiate a fetal heart rate signal source from a maternal heart rate source in all situations. These are some of the signal sources that might be taken as FHR signal source by mistake:

- High maternal heart rate signal.
- Maternal aorta or other large vessels signals.
- Electrical impulse from the maternal heart transmitted through a recently deceased fetus.
- Movement of the deceased fetus during or following maternal movement.

So you need to confirm fetal life by other means before starting to use the fetal monitor, such as using a fetoscope, stethoscope, Pinard stethoscope or obstetric ultrasonography.

7.2 Monitoring FHR with Ultrasound

The ultrasound monitoring is a method to obtain FHR on maternal abdominal wall. Place a US transducer (Ultrasound transducer) on maternal abdomen. It transmits low energy ultrasound wave to the fetal heart, and receives the echo signal.

WARNING

Make sure you have confirmed the fetal life by other means before using this monitor for FHR monitoring.

7.2.1 Parts Required

- 1) US transducer
- 2) Aquasonic coupling gel
- 3) Belt

7.2.2 FHR Monitoring Procedure

1) Placing Transducer Belt

Place the transducer belts across the bed, ensuring that the belt will be around the abdomen when it is fastened. Lay the patient on the bed.

Alternatively, the patient can take a sitting position. Arrange the belt around her abdomen.

2) Determining the Transducer Position

- Determine the fetal position using Leopold's maneuvers.
- Search for the location of the fetal heart using a stethoscope or a fetoscope. The best fetal heart signal can be obtained through the fetal back.

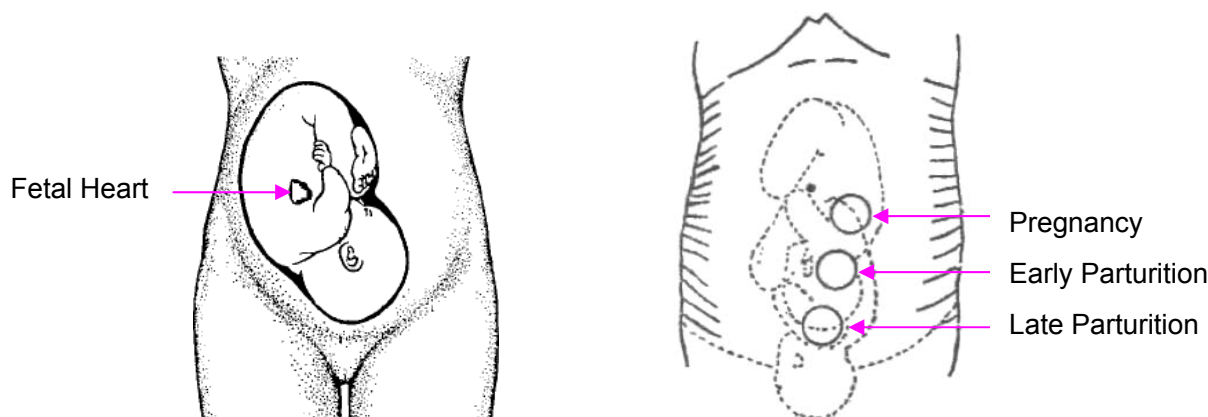

Figure 7-1 Positioning Ultrasound Transducer (single fetus)

- During parturition, the fetal heart moves downward as the labor progresses. It is recommended to move the transducer along with the fetus.

3) Acquiring Fetal Heart Signal

Apply a certain amount of acoustic gel on the transducer and move it slowly around the fetus site. Find at least 2 or 3 sites, and choose the one where the clearest, most sonorous and steady fetal heart sound is heard.

4) Fixing the Transducer

Wrap the abdomen with the belt over the transducer. Fix the transducer by pushing its buckle through the overlapping section of the belt.

Make sure the belt fits the patient snugly but comfortably. Meanwhile, fetus heart beat sound is heard; the FHR trace and numeric are displayed. During long-time monitoring, the gel may dry out as the transducer moves around. Add more gel in time if it is inadequate.

5) Confirming that the Fetus is the Signal Source

Ultrasound Doppler technology is utilized to observe the fetal heart rate externally, there are possibilities that maternal heart rate signal is mistaken for FHR signal. It is highly recommended to confirm that the fetus is the signal source continuously. You can feel the maternal pulse at the same time.

If the maternal heart signal is misidentified as the fetal heart signal, Repositioning of the transducer is needed.

NOTE:

- 1 Do not mistake the high maternal heart rate for fetal heart rate. The fetal pulse can be distinguished from the maternal pulse by feeling the mother's pulse during the examination.
- 2 The best quality records will only be obtained if the probe is placed in the optimum position. Positions with strong placental sounds or umbilical blood flow sound should be avoided.
- 3 If the fetus is in the cephalic presentation and the mother is supine, the clearest heart sound will normally be found on the midline below the umbilicus. During monitoring, the patient's prolonged lying in the supine position should be avoided owing to the possibility of supine hypotension. Sitting up or lateral positions are preferable and may be more comfortable.
- 4 It is impossible to examine FHR unless a clear fetal heart signal is detected.

7.2.3 Switching FHR Alarm On or Off

Always check if the alarm settings are appropriate for your patient before starting a monitoring.

You can choose to switch the FHR alarm on or off. If the fetal heart alarm is switched off, the monitor will no longer give any audible or visual warning for this monitoring item.

- 1 Select the setup key  on the main interface.
- 2 Select **Alarm > FHR > Alarm**.
- 3 Select **ON** (default) or **OFF**.
- 4 Select **OK**.

When the alarm is switched off, an alarm switched-off symbol  appears in the numeric window. For example:



WARNING

Do not switch the alarm off for the condition where the patient's safety maybe endangered.

7.2.4 Changing FHR Alarm Limits

You can change the FHR alarm limits. The alarm limits you set determine the conditions that trigger the alarm.

- 1 Select the setup key  on the main interface.
- 2 Select **Alarm > FHR**.
- 3 Select a value from 60 ~ 205 for **Low Alarm Limit**.
- 4 Select a value from 65 ~ 210 for **High Alarm Limit**.
- 5 Select **OK**.

7.2.5 Changing FHR Alarm Delay

You can change the FHR alarm delay. The alarm delay indicates how long the measured result continues exceeding its limit before the alarm is triggered.

- 1 Select the setup key  on the main interface.
- 2 Select **Alarm > FHR1 > Alarm Delay**.
- 3 Select a value from 0 ~ 300.
- 4 Select **OK**.

7.3 Monitoring FHR with DECG (F6)

NOTE:

This feature is only available on **F6**.

7.3.1 Contraindications

The fetal spiral electrode can be used when amniotic membranes are adequately ruptured and sufficient cervical dilatation is ensured. The fetal electrode tip is designed to penetrate the epidermis of the fetus; therefore, trauma, hemorrhage and/or infection can occur. The electrode should be used with strict adherence to aseptic technique.

The fetal spiral electrode should not be applied to the fetal face, fontanelles or genitalia.

Do not apply the fetal spiral electrode when placenta previa is present; when the mother has visible genital herpes lesions or reports symptoms of prodromal lesions; when the mother is HIV sero-positive; when mother is a confirmed carrier of hemophilia and the fetus is affected or of unknown status; or when it is not possible to identify fetal presenting part where application is being considered. This method is not recommended when fetus is extremely premature, or in the presence of a maternal infection such as Hepatitis B, Group B hemolytic strep, syphilis or gonorrhea, unless a clear benefit to the fetus or mother can be established.

7.3.2 Parts Required

- 1) DECG cable
- 2) Fetal spiral electrode
- 3) Disposable attachment pad electrode

The following illustration shows how these parts should be connected:

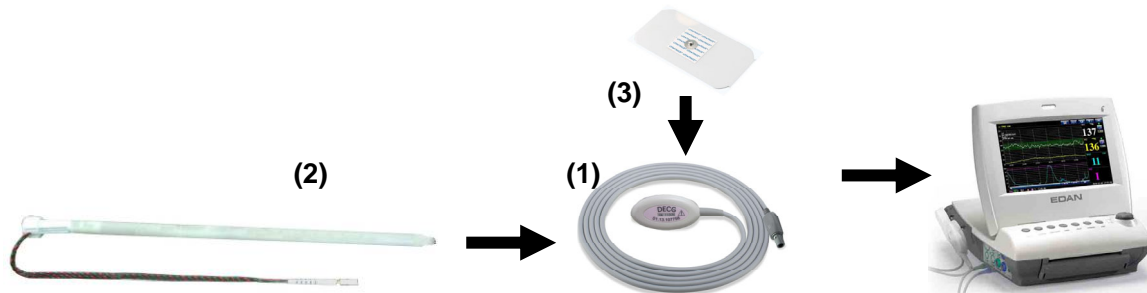

Figure 7-2 Connection for DECG Monitoring

7.3.3 Preparing Patient's Skin Prior to Placing Electrodes

The skin is a poor conductor of electricity; therefore preparation of the patient's skin is important to facilitate good electrode contact to skin.

- 1) Shave hair from electrode sites, if necessary.
- 2) Wash the sites thoroughly with soap and water. (Do not use ether or pure alcohol, which will increase skin impedance)
- 3) Rub the skin briskly to increase capillary blood flow in the tissues.
- 4) Remove skin scurf and grease.

7.3.4 Switching DECG Beep On or Off

When the DECG beep is enabled, the monitor gives a beep sound of DECG.

To switch DECG beep on or off,

- 1 Select the setup key  on the main interface.
- 2 Select **Fetus > DECG Beep**.
- 3 Select **0** (default) ~ **9**.
- 4 Select **OK**.

NOTE:

Once the DECG beep volume is changed, the sound switches to channel 1 automatically. Therefore, it is advised against changing DECG beep volume in the monitoring process.

7.3.5 Switching the Artifact Suppression On or Off

When monitoring FHR with DECG, artifacts may occur due to bad connection of the spiral electrode, excessive motion of the mother, electromyographic interference etc.. The **Artifact Suppression** feature is designed to eliminate the interference. When artifact suppression is on,

artifacts are suppressed and not recorded. When it is off, the artifacts are shown as well as the fetal heartbeats.

You can choose to switch the artifact suppression on or off.

- 1 Select the setup key  on the main interface.
- 2 Select **Fetus > Artifact Suppression**.
- 3 Select **ON** (default) or **OFF**.
- 4 Select **OK**.

WARNING

When artifact suppression is on, fetal arrhythmia will also be suppressed. Therefore, if fetal arrhythmia is suspected, switch artifact suppression off.

7.3.6 Directions for Using Fetal Spiral Electrode

- 1 With the patient in the dorsal lithotomy position, perform a vaginal examination and clearly identify the fetal presenting part.
- 2 Remove the spiral electrode from the package; leave the electrode wires locked in the handle notch.
- 3 Gently bend the guide tube to the desired angle.
- 4 Hold the drive handle, ensure the spiral electrode is retracted about one inch (2.5 cm) from the distal end of the guide tube.
- 5 Place the guide tube firmly against the identified presenting part.
- 6 Maintain pressure against the fetal presenting part with guide and drive tubes. Rotate the drive tube by rotating the drive handle clockwise until gentle resistance is encountered. Resistance to further rotation and recoil of the drive handle indicates that the spiral electrode is well attached to the fetus.
- 7 Release the electrode wires from the handle notch and straighten them. Slide the drive and guide tubes off the electrode wires.
- 8 Insert the safety cap into DECG cable.

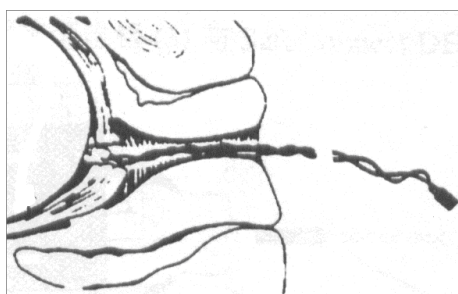

Figure 7-3 The well attached fetal spiral electrode

7.3.7 DECG Monitoring Procedure

- 1 Perform a vaginal examination to identify the fetal presenting part.
- 2 Prepare the patient's skin using the procedures described in section 7.3.3 *Preparing the Patient's Skin Prior to Placing Electrodes*.
- 3 Attach the fetal spiral electrode to the fetal presenting part using the procedures described in section 7.3.6 *Directions for Using Fetal Spiral Electrode*.
- 4 Fix an attachment pad electrode to DECG cable.
- 5 Remove the film on the back of the electrode and place the electrode on maternal thigh; press it firmly in place.
- 6 Connect the fetal spiral electrode to the DECG cable.
- 7 Insert connector of DECG cable into the DECG socket of the monitor.

WARNING

Do not plug the fetal spiral electrode wire into the power socket.

CAUTION

Do not mistake the higher maternal heart rate for DECG.

NOTE:

- 1 If there is any doubt as to the presence of a fetal heart signal with ECG, check with the US transducer on the patient's abdomen or with a separate diagnostic instrument. The presence of an audible heart sound at a rate distinct from that of the maternal pulse is unequivocal evidence of the fetal life.
- 2 After the electrode is well attached, allow a few minutes for the electrode and fetal tissue to become stabilized. It is essential that the ECG signal electrode is in good contact with the fetal presenting part.

7.3.7 Detaching Fetal Spiral Electrode

To detach the fetal spiral electrode, rotate it counterclockwise until it is free from the fetal presenting part. Do not pull the electrode from the fetal skin forcefully.

Dispose of the used fetal spiral electrode in a proper way. Do not use it again.

7.4 Monitoring Twin FHRs

7.4.1 Monitoring Twins Externally

To monitor twin FHRs externally, you need to connect a US transducer to US1 socket and the second US transducer to US2 socket of the monitor. Follow the instructions described in Section

7.2 Monitoring FHR with Ultrasound to acquire FHR signals for both channels. Press **CHANNEL** key to switch the FH sound from one channel to the other.

When the two US transducers are fixed, make sure FH sounds from both channels are clear, two FHR traces and two FHR numerics are displayed on the screen.

NOTE:

To ensure that both transducers stay at the optimum location, each transducer should be fixed with a separate belt.

7.4.2 Monitoring Internally

Alternatively, you can monitor a FH using ultrasound externally, and monitor the second FH using DECG internally.

Connect the US transducer to US2 socket; connect DECG cable to DECG socket.

Monitor one twin with a US transducer using the procedures described in Section *7.2 Monitoring FHR with Ultrasound*.

Monitor the other twin with a DECG cable using the procedures described in Section *7.3 Monitoring FHR with DECG*.

CAUTION

The US transducer must be connected to US2 socket. If the US transducer connects to US1 socket while DECG cable is connected to DECG socket, the FHR trace and numeric from US1 will not be displayed.

7.4.3 Signals Overlap Verification (SOV)

When monitoring twins, there are possibilities that one twin's FHR signal is mistaken for the other one's signal. The monitor provides signals overlap verification (SOV) function to reduce these possibilities.

In the process of monitoring, if the SOV detects signals overlapping, an alarm message "Signals Overlap (FHR1/DFHR, FHR2)" will appear on the screen to warn you. Checking the patient and reposition of transducers might be needed.

7.4.4 Changing FHR2 Offset

In order to distinguish FHR1/DFHR trace from FHR2 trace, FHR2 offset is provided to help you separate the two traces by an offset of -20 bpm or +20 bpm.

To change the FHR2/DECG offset,

- 1 Select the setup key  on the main interface.
- 2 Select **Recorder > FHR2 Offset**.

3 Select **-20 bpm** (default), **0 bpm** or **+20bpm**.

4 Select **OK**.

This preset FHR2 offset will be printed on the recorder paper every 10 minutes.

“FHR2: -20bpm”: the FHR2 trace is 20bpm lower than it really is.

“FHR2: +20bpm”: the FHR2 trace is 20bpm higher than it really is.

7.5 Monitoring Uterine Activity Externally

7.5.1 Parts Required

- 1) TOCO transducer 2) Belt

7.5.2 TOCO Monitoring Procedure

1) Placing Transducer Belt

Place the transducer belts across the bed, ensuring that the belt will be around the abdomen when it is fastened. Lay the patient on the bed.

Alternatively, the patient can take a sitting position. Arrange the belt around her abdomen.

2) Fixing the Transducer

Wipe any gel remaining on abdomen around the fundus area.

Place the TOCO transducer on the patient's abdomen, which is flat and approximately 3 cm away from the fundus, e.g. slightly above the umbilicus on the left or on the right. The position should be different for different purposes: place the transducer close to the fetal buttocks for NST, and place it on fetal back in delivery.

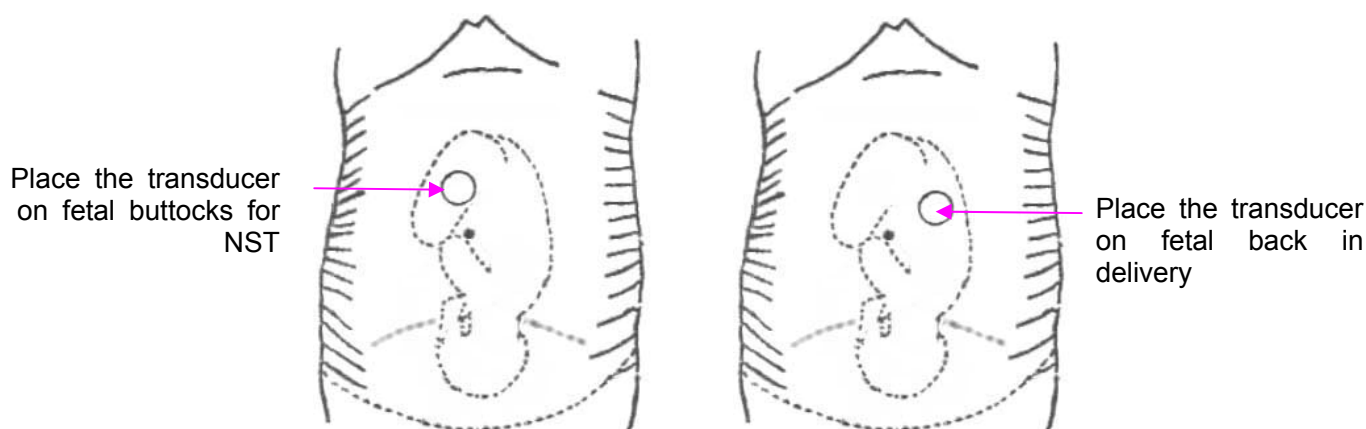

Figure 7-4 Positioning TOCO Transducer

Wrap the abdomen with the belt over the transducer. Fix the transducer by pushing its buckle through the overlapping section of the belt. Make sure the belt fits the patient snugly but comfortably.

3) Adjusting the Numeric to Zero

Press the **AUTO ZERO** key to adjust the numeric to the baseline. Make sure this is not done during a contraction.

The uterine activity reading at this point should be 30 ~ 90. A flat-top aligned with 100 on the TOCO scale indicates the belt is too tight, and you need to adjust it.

Wipe off any gel presents on abdomen around this area.

NOTE:

Do not apply aquasonic coupling gel on a TOCO transducer or its contact area.

7.5.3 Changing UA Baseline

You can change the UA baseline,

- 1 Select the setup key  on the main interface.
- 2 Select **Fetus > UA Baseline**.
- 3 Select **5, 10** (default), **15** or **20**.
- 4 Select **OK**.

NOTE:

If the monitor has been configured with IUP, the TOCO baseline is 10 and the IUP baseline is 0. They are not adjustable.

7.5.4 Testing TOCO Transducers

To test a TOCO transducer:

- 1) Switch on the monitor.
- 2) Connect the TOCO transducer to the fetal monitor.
- 3) Gently press the center of the transducer.



Figure 7-5 Testing a TOCO Transducer

4) Check that the value on the display shows this change in pressure.

If a TOCO transducer fails the test, repeat this test with another transducer. If the second one passes the test, defect of the first transducer is confirmed. Replace it with a good one. If the second transducer fails the test as well, contact the manufacturer for service.

7.6 Monitoring Uterine Activity Internally (F6)

NOTE:

This feature is only available on **F6**.

7.6.1 Parts Required

- 1) Disposable intrauterine pressure catheter ACCU-TRACE™ IUPC (“IUPC” for short)
- 2) Reusable intrauterine pressure cable (“IUP cable” for short)
- 3) Reusable intrauterine pressure connecting cable (“connecting cable” for short)

The following illustration shows how these parts should be connected:

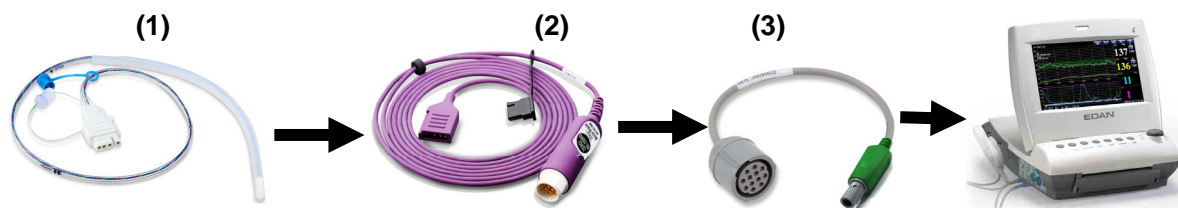

Figure 7-6 Connection for IUP Monitoring

7.6.2 Directions for Use of IUPC

Preparation

- 1) Gather supplies: ACCU-TRACE IUPC, reusable cable, and amnioinfusion supplies if needed.
- 2) Open the sterile ACCU-TRACE IUPC package.

Insertion

NOTE:

This product is designed for use with the introducer.

- 3) Using aseptic technique, remove the catheter from the package.
- 4) Perform vaginal exam to ensure ruptured membranes and adequate dilation.
- 5) Advance the catheter tip to the cervical os along the examination hand, using the hand as a guide. Do not advance the introducer through the cervix.
- 6) Continue to gently advance the catheter tip through the cervical os and feed the catheter into the intra-amniotic cavity until the 45cm mark is at the introitus. If the 45cm mark is

not clearly visible, stop advancing when the ● symbol on the catheter meets the introducer.

NOTE:

For easier insertion, do not twist the catheter in the introducer.

- 7) The IUPC may be spontaneously filled with amniotic fluid. This can be seen in the clear lumen of the catheter. The filter cap will prevent the amniotic fluid from leaking.
- 8) Slide the introducer out of the vagina along the catheter. When the introducer is completely out of the vagina, slide thumb between catheter and introducer tab, which will begin to separate the introducer from the catheter.

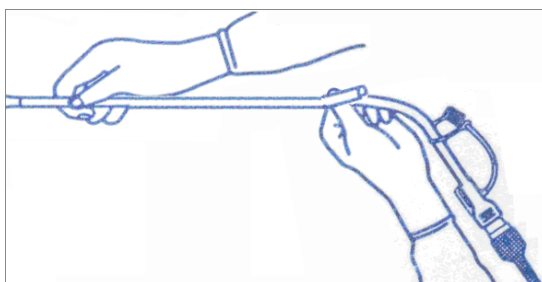

Figure 7-7 Separate the introducer

- 9) Anchor the catheter in place with one hand, and pull the introducer straight back off the catheter.

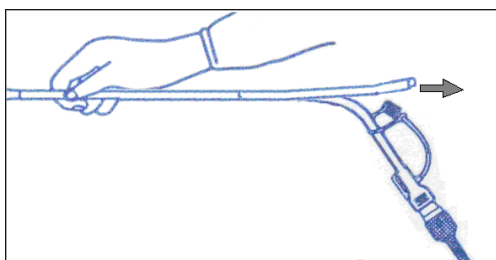

Figure 7-8 Remove the introducer

- 10) Remove the liner from the adhesive pad, and then adhere the pad to the patient's skin. Secure the catheter by placing the catheter attachment strap to the adhesive pad.

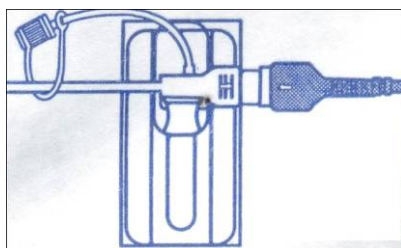

Figure 7-9 Secure the adhesive pad to mother

Rezeroing the System During Monitoring

- 1) With the catheter connected to the IUP cable, momentarily pressing the re-zero button on the pressure cable. The green light on the cable will flash for five seconds.

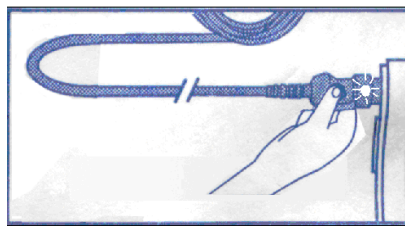

Figure 7-10 Rezeroing the system

- 2) During this period, adjust the monitor to zero by pressing **AUTO ZERO** key.

WARNING

- 1 Before insertion of IUPC, placental position should be confirmed, amniotic membranes are adequately ruptured and sufficient cervical dilatation is assured.
- 2 Try to insert the catheter opposite the placental site. Do not insert the introducer beyond the cervical OS. Use it with caution when uterine infection is present.
- 3 If resistance is met at any time during insertion, withdraw the catheter slightly and try at a different angle. Forced insertion may result in patient's discomfort or injury.

CAUTION

- 1 Since procedures vary according to hospital needs/preferences, it is the responsibility of the hospital staff to determine exact policies and procedures for both monitoring and amnioinfusion. The safe and effective use of the IUPC depends on the skill of the clinician who applies / uses it.
- 2 The Product has been sterilized by gamma radiation and is sterilized and non-pyrogenic unless package is broken or open. Do not re-sterilize it.

NOTE:

Refer to the instruction on the package for more information about using the IUPC.

7.6.3 IUP Monitoring Procedure

- 1) Insert IUPC using the procedure described in section 7.6.2 *Directions for Use of IUPC*.
- 2) Connect the IUPC to the IUP cable.

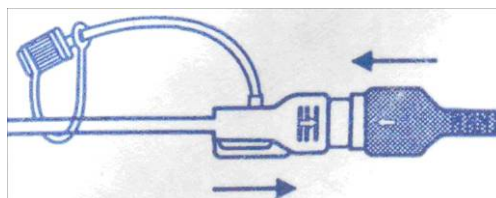

Figure 7-11 Connect catheter to pressure cable

- 3) Plug the IUP cable to the TOCO/IUP socket of the monitor.
- 4) Momentarily pressing the re-zero button on the IUP cable. The green light on the cable will flash for five seconds. During this period, zero the monitor by pressing the **AUTO**

ZERO key. Make sure the display numeric and trace are both “0”.

- 5) Ask the mother to cough. A spike on the trace in response to the cough indicates proper positioning and function of the IUPC.
- 6) Wash timely during monitoring. A spike on the tracing will respond to the washing.

7.6.4 Checking Intrauterine Pressure Cable Function

To test an IUP cable's function:

- 1) Disconnect the catheter from the cable. Insert the cable check plug into the catheter end of the cable.

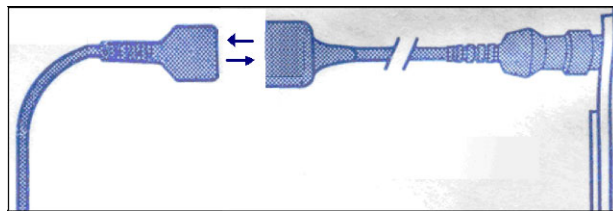

Figure 7-12 Test the pressure cable

- 2) Verify that the green light is continuously lit (no flashing).
- 3) If the light does not illuminate, replace the cable.

NOTE:

- 1 If the light is flashing, verify that the cable check plug is inserted completely into the cable.
- 2 The cable test function is not intended to check the accuracy of the system, only to confirm cable function.

7.7 Monitoring Fetal Movement

7.7.1 Auto Fetal Movement Monitoring (AFM)

During fetal heart monitoring with ultrasound, the fetal movement signals are also detected. The fetal movement signals differ from the Doppler heart rate signals in that they have larger extent and lower frequency. The larger extent is because of the bigger scope of moving areas (e.g., the fetal arms or legs); lower frequency is because of the lower velocity of the fetal movements compared with those of the fetal heart.

Only US1 channel can perform AFM. But be aware that when monitoring twins, the movements detected by US1 may also be caused by the second fetus's movement.

The movement of the fetus will be detected and displayed in the form of a trace on the screen and the recorder paper.

AFM monitoring can be switched off; its gain is adjustable.

NOTE:

AFM monitoring is not available when FHR is monitored by DECG or a cordless ultrasound transducer.

7.7.2 Enabling or Disabling AFM Trace

The AFM trace on the screen and recorder paper can be enabled or disabled.

- 1 Select the setup key  on the main interface.
- 2 Select **Fetus > AFM**.
- 3 Select **ON** or **OFF** (default).
- 4 Select **OK**.

7.7.3 Changing AFM Gain

You can change the AFM gain. The AFM gain affects overall numeric and scope of the AFM trace.

- 1 Select the setup key  on the main interface.
- 2 Select **Fetus > AFM Gain**.
- 3 Select **1, 2, 3** (default) or **4**.
- 4 Select **OK**.

7.7.4 Choosing AFM Mode

When AFM monitoring is enabled, the AFM monitoring result is displayed either in the form of a trace or black marks.

To choose AFM mode,

- 1 Select the setup key  on the main interface.
- 2 Select **Fetus > AFM Mode**.
- 3 Select **Trace** (default) or **Blackmark**.
- 4 Select **OK**.

7.7.5 Changing AFM Threshold

When AFM monitoring is enabled, you can change the AFM threshold.

To change the AFM threshold,

- 1 Select the setup key  on the main interface.
- 2 Select **Fetus > AFM Threshold**.
- 3 Select a value from 0 ~ 100 for **AFM Threshold**, and the default is **20**.
- 4 Select **OK**.

7.7.6 Choosing FM Source

When AFM monitoring is enabled, the FM has two sources: AFM and MFM.

To choose the FM source,

- 1 Select the setup key  on the main interface.
- 2 Select **Fetus > FM Source**.
- 3 Select **MFM** (default) or **AFM**.
- 4 Select **OK**.

7.7.7 Manual Fetal Movement Monitoring (MFM)

MFM result comes from the patient's feeling of fetal movement. The count will be displayed on the screen in MFM numeric area.

- 1) Insert the FM marker connector into the **MARK** socket on the monitor.
- 2) Let the patient hold the marker in hand; ask her to press the top key of it when a fetal movement is felt. Continuous movements in 5 seconds are considered to be one movement and only press the key once.

7.7.8 Changing MFM Volume

The monitor gives a sound when the FM marker key is pressed, and the volume is adjustable.

To change the MFM volume,

- 1 Select the setup key  on the main interface.
- 2 Select **Fetus > MFM Volume**.
- 3 Select **Low** or **High** (default).
- 4 Select **OK**.

7.8 Start Monitoring

After the **START** key is pressed, the monitor automatically zeroes the pressure, clears the MFM count and starts monitoring.

If the **Auto Printing** is disabled, press the **PRINT** key to start printing.

7.9 Inputting Maternal Information (Mat. Info)

7.9.1 Auto ID

After you press the **START** key, the system creates an auto-ID for the present patient. (if Mat. Info inputting is switched off.) The auto-ID consists of the date and time when the monitoring starts.

7.9.2 Changing Maternal Information

You can change the patient's information after the monitoring starts:

- 1 Select Mat. Info key  on the main interface.

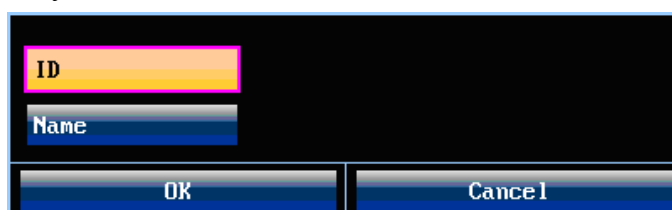

Figure 7-13 Mat. Info inputting menu

- 2 Select **ID**.

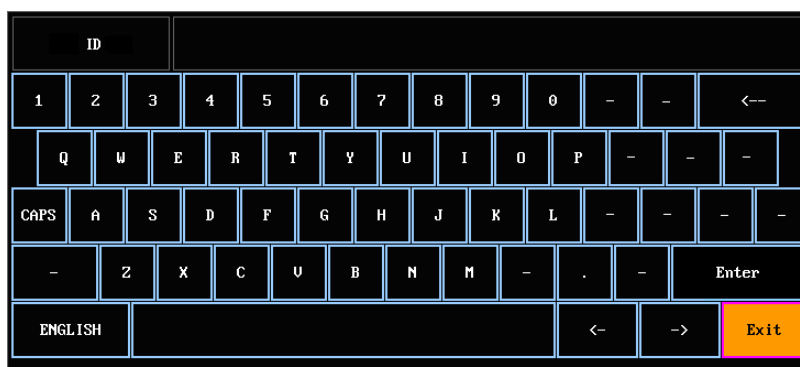

Figure 7-14 Soft keyboard

- 3 Select the required number for patient's ID on the soft keyboard.
- 4 Select **Enter**.
- 5 Select **Name**.
- 6 Select the required letter for patient's name on the soft keyboard.
- 7 Select **Enter**.
- 8 Select **OK**.

The monitoring does not stop when you change maternal information. After you select **OK** to exit, the new ID takes the place of the old one for this patient.

NOTE:

- 1 Pressing the **START** key separates two patients. The monitor only displays the most recent ID for the same patient.
- 2 If printing starts automatically with the monitoring, the first ID printed on the recorder

paper will be the auto-ID. The new ID will be printed 10 minutes later.

- 3 The ID and name are shown on the screen, the paper printout and the archive list.
- 4 For the non-English system, more letters are provided for inputting the name. Select the key on the bottom left corner to toggle between them.

7.9.3 Switching Mat. Info Inputting On or Off

The **Mat. Info inputting** function allows the menu to pop up automatically after the **START** key is pressed. After you input the mother's information and exit from the menu, the monitoring starts immediately.

To switch the **Mat. Info Inputting** on or off:

- 1 Select the setup key  on the main interface.
- 2 Select **Start Monitoring > Mat. Info**.
- 3 Select **ON** or **OFF** (default).
- 4 Select **OK**.

Chapter 8 Fetal Monitoring Display (F6)

8.1 Traces

WARNING

Due to the LCD size, resolution and system settings, the traces displayed on the screen may look different from the recorder printout. The printout should prevail when making diagnoses.

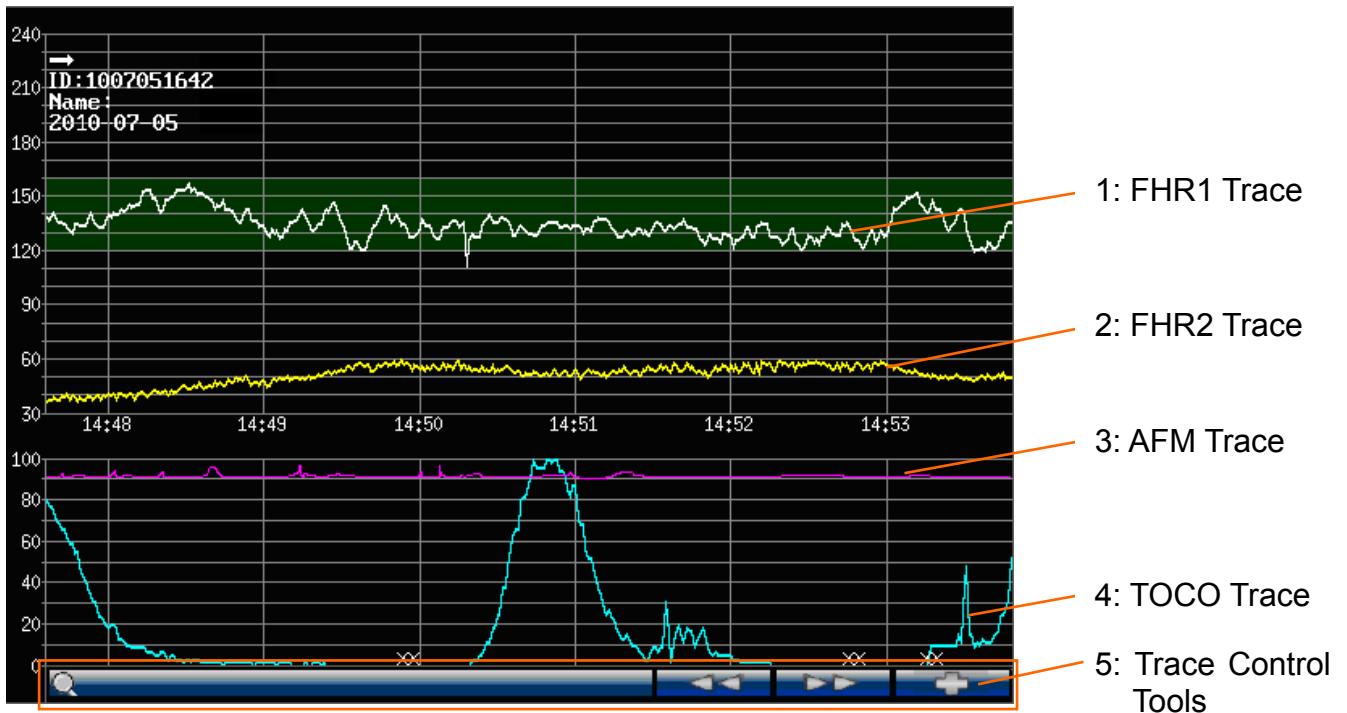

Figure 8-1 Traces

During monitoring or reviewing, the trace window displays four traces: FHR1 trace, FHR2 trace (dual configuration), AFM trace and TOCO trace.

FHR1/FHR2 trace

The y-axis of the trace indicates the numerics of FHR. The range is 30 bpm ~ 240 bpm (American standard) or 50 bpm ~ 210 bpm (International standard).

AFM trace

The y-axis indicates the scope of fetal movement.

NOTE:

The AFM trace is only for reference, please take the MFM marks as criterion.

TOCO trace

The y-axis indicates the numeric of TOCO. The range is 0% ~ 100%.

If FHR is monitored using DECG, and the DECG trace is switched on in the hardware setup (only

service engineers have access to it), a DECG trace is shown underneath other traces on the screen.

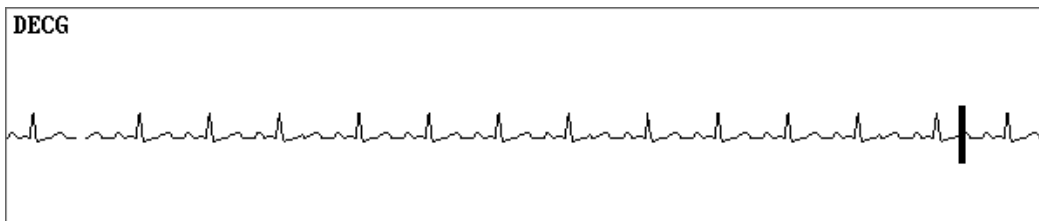

Besides, some other symbols appear among the traces:

- ➔ This symbol indicates the new monitoring starts.
- ↑ This symbol indicates a manual fetal movement, and it appears after the patient presses the FM marker when she feels a fetal movement.
- ↓ This symbol indicates the **MARK** key is pressed to record an event, such as the patient turning around, taking injection.
- xx This symbol indicates the monitor is zeroed by pressing **AUTO ZERO** key.

8.1.1 Changing Time Scale

The fetal monitoring traces share the same time scale, which displays the time every two minutes. This scale is either in real time format or relative time format. Real time is the time of the monitor. Relative time records the elapsed time for the current monitoring.

To change this time format:

- 1 Select the setup key  on the main interface.
- 2 Select **Date And Time > Time Scale**.
- 3 Select **Real Time** (default) or **Relative Time**.
- 4 Select **OK**.

NOTE:

The real time contains only the hour and minute, but no second. As a result, the time scale may correspond to the 0 ~ 59th second of the system time. Do not mistake the time scale for the exact time.

8.2 Trace Control Tools



Figure 8-2 Trace control tools

- 1 Searching Key
- 2, 3 Reviewing Keys
- 4 CTG Analyzing Key

8.2.1 Data Saving

When the **START** key is pressed, the monitor saves data of the previous ID in a file, and then clears it from the main interface. The main interface only displays the new patient’s data. During monitoring, the data is saved every 10 minutes. All data of the same patient is saved in a file (the maximum duration is 24 hours, the rest data is saved in another file.)

The files are stored in the monitor. When the data amount reaches the maximum capacity (300 files or approximately 60-hour), the monitor deletes the oldest file(s) automatically.

8.2.2 Searching for a File

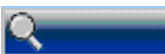
The searching key  under the traces is used to search for a patient’s data file saved in the monitor.

To search for a patient,

- 1 Select the searching key to open the file list. It contains six sets of most recent patient’s ID, name and start time of monitoring. Select the required item, this file is loaded to the main interface immediately.



Figure 8-3 File List

If the required file is not in this list,

- 2 Select **MORE** to open the **Patient Searching** window.



Figure 8-4 Patient Searching

3 Select **ID**, input the patient ID with the soft keyboard and select **Enter**.

4 Select **Name**, input the patient's name with the soft keyboard and select **Enter**.



NOTE:

You can input only a part of the patient ID or name. However, the more information you input, the more accurate result you will get.

5 Select **Search**. The files with the matched information are listed in the window.

6 Select the required item, this file is loaded to the main interface immediately. You can review the traces backward or forward.

8.2.3 Reviewing

The reviewing keys  (backward key) and  (forward key) are used to review the traces. The word **REVIEW** is shown in the background when reviewing the traces.

Select the backward key to review the previous traces. The traces start to retreat. The amount of the progress symbol "<" on top of the traces indicates the retreating speed. Rotate the control knob anticlockwise to increase the speed until it reaches the maximum. Rotate the knob clockwise to decrease the speed until it reaches the minimum. Press the knob.

Select the forward key to review the next traces. The traces start to advance. The amount of the progress symbol ">" on top of the traces indicates the advancing speed. Rotate the control knob clockwise to increase the speed until it reaches the maximum. Rotate the knob anticlockwise to decrease the speed until it reaches the minimum. Press the knob to pause.

When the reviewing is paused, the progress symbol turns to <--X%-->. If the **PRINT** key is pressed at this moment, the recorder will print the traces starting from the left edge of the screen at a high speed.

X% indicates the proportion of current traces positioned in the whole reviewable traces.

Move the cursor away from the trace control tools to return to the real-time main interface. If no operation is performed in 10 seconds, the monitor switches to real-time interface automatically, unless the printing is in process.

When reviewing the traces, the monitor does not stop. The FH sound and numerics are all real time information of the current patient.

WARNING

The reviewing printout is provided for reference only. Please take the real-time printout as criterion when making diagnoses.

NOTE:

- 1 The main interface only displays traces and patient information of one file. If you want to review another file you should search for the file and load it.
- 2 For a real-time monitoring patient, you can print all her traces, including SpO2 trace.

However, when printing traces in a file, the SpO2 trace cannot be printed.

- 3 You must pause before printing starts. Printing in the process of playback might result in failure information on the paper.
- 4 After the reviewed data has been printed out, the recorder does not switch back to real-time printing automatically.

8.2.4 CTG Analysis

CTG analysis aims at a real-time trace, providing some reference data for the physicians. It only analyzes the real-time trace after it's been printed for 10 minutes, and the longest duration is 60 minutes.

WARNING

- 1 CTG analysis is used for the surveillance of pregnancies and not in delivery room of childbirth.
- 2 CTG analysis is just an analysis intended to assist the physicians in interpreting the waveforms. Conclusions should be drawn on the basis of the physicians' diagnosis.
- 3 This analysis describes the fetal heart rate, the tocography and the fetal movements. It's the responsibility of qualified medical staff to do the diagnostic interpretation of the waveform.

8.2.4.1 Enabling/Disabling CTG analysis

- 1 Select the setup key  on the main interface.
- 2 Select **General Setup > CTG Analysis**.
- 3 Select **ON** or **OFF** (default).
- 4 Select **OK**.

A CTG analysis key  appears on the main interface, indicating that CTG analysis is enabled.

8.2.4.3 CTG analyzing

NOTE:

- 1 CTG analyze starts after the real-time trace has been printed for 10 minutes.
- 2 The CTG analysis result is for reference only.

After the real-time trace is printed for 10 minutes, select the CTG analysis key  on the main interface. The analysis result window opens.

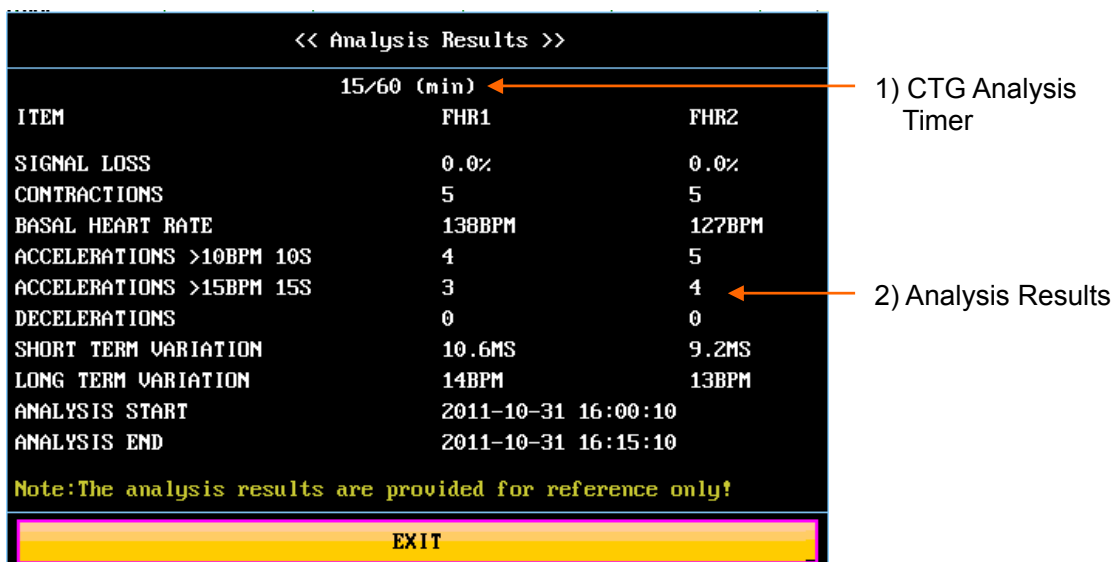

Figure 8-5 CTG Analysis Results

Refer to figure 8-6, the CTG analysis results on the screen include:

1) CTG Analysis Timer:

The CTG analysis timer starts when the recorder starts printing; it stops when the timer reaches 60 minutes (the timer turns into >60) and resets when the recorder stops printing.

2) CTG Analysis Results:

SIGNAL LOSS:	the proportion of the signal loss. If it is larger than 10%, analysis results cannot be acquired.
CONTRACTIONS:	the contraction time during analysis.
BASAL HEART RATE:	the average FHR in 10 minutes when it is not influenced by fetal movement or contractions.
ACCELERATIONS:	the acceleration time, including the acceleration with amplitude larger than 10bpm and lasts more than 10 seconds, and the acceleration with amplitude larger than 15bpm and lasts more than 15 seconds.
DECELERATIONS:	the deceleration time.
SHORT TERM VARIATION:	the short-term variation analysis result.
LONG TERM VARIATION:	the long-term variation analysis result.
ANALYSIS START:	the start time of the analysis.
ANALYSIS END:	the finishing time of the analysis.

During 10 to 60-minute of the timer, the monitor gives CTG analysis results every minute.

At the end of the printing, the recorder prints the CTG analysis results of this moment on the recorder paper.

Be aware that CTG analysis result is a calculation output. It can be used as a reference to assist medical personnel in making correct diagnosis, instead of replacing it.

NOTE:

Do not disconnect the ultrasound transducer(s) before the printing stops, otherwise the analysis results will not be printed.

8.2.5 Marking a Note

When there is a significant event, you can press the **MARK** key on the front panel to add a note. An event mark ↓ will appear on both the main interface and the recorder paper.

However, an event mark cannot clearly indicate an event. **Smart Notes** provides a list of annotation for the events, including events that relate to drugs, positions, membranes, procedures, antenatal, reasons and others.

8.2.5.1 Enabling/disabling Smart Notes

To enable or disable **Smart Notes**,

- 1 Select the setup key  on the main interface.
- 2 Select **General Setup > Smart Notes**.
- 3 Select **ON** or **OFF** (default).
- 4 Select **OK**.

A smart note editing key  appears next to the **Smart Notes** item.



8.2.5.2 Annotating an event

Once **Smart Notes** is enabled, press the **MARK** key on the front panel to open the smart note list, choose an event catalog and then choose an annotation from the list.

The annotation of this event will be printed in the top area of recorder paper during real-time printing.

8.2.5.3 Changing smart note content

You can change the smart note content in the smart note list by performing the following steps:

- 1 Select the setup key  on the main interface.
- 2 Select **General Setup**.
- 3 Select the smart note editing key .
- 4 Select a catalog.
- 5 Select a note.
- 6 Use the soft keyboard to edit the note content.
- 7 Select **Enter**.
- 8 Select **OK**.

8.3 Numerics

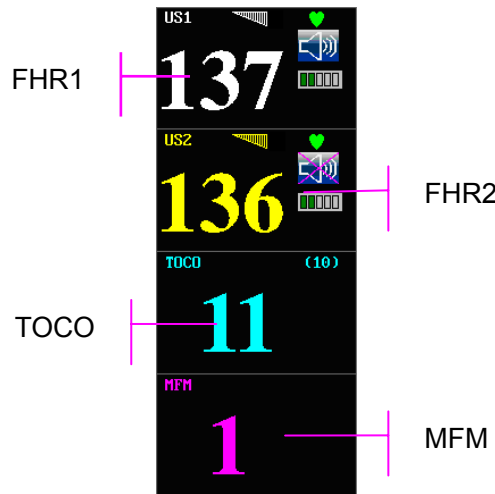











Figure 8-6 Fetal Monitoring Numerics

The fetal monitoring values in the numeric window include FHR1/DFHR value, FHR2 value, TOCO/IUP value and FM count:

<p>FHR1/DFHR</p>   <p>FHR2</p> 	 : FHR signal quality. When the quality is poor, it turns into  .  : FH refreshing rate  : FH sound volume adjusting key  : FH sound volume indicator 137: FHR1/DFHR measurement numeric. If the US1 socket is not connected with a US transducer and DECG socket is not connected with a DECG cable, nothing displays here; if the transducer/cable is connected but no monitoring is going on, it displays ---. 136: FHR2 measurement numeric. If the US2 socket is not connected with a US transducer when switching on, it displays OFF but no numeric here; if the transducer is connected but no monitoring is going on, it displays ---.
<p>TOCO/IUP</p> 	(10)/(0): UA baseline 11: current UA measurement numeric
<p>FM</p> 	MFM/AFM: FM source 1: FM count

8.4 Fetal Monitoring Alarm Messages

During fetal monitoring, the monitor gives alarms for the situations that need the physicians to pay attention to. The alarm messages are listed below.

8.4.1 Patient Alarm Messages

Alarm Message	Source	Cause	Countermeasure
Medium Level			
**FHR1 HIGH or ** FHR1 xxx > yyy, **FHR2 HIGH or ** FHR2 xxx > yyy	US	FHR1 or FHR2 measuring result (xxx) is higher than the set upper limit (yyy) over the alarm delay time.	Check if the alarm limits are suitable; check the patient's condition.
**FHR1 LOW or ** FHR1 xxx < yyy, **FHR2 LOW or ** FHR2 xxx < yyy	US	FHR1 or FHR2 measuring result (xxx) is lower than the set lower limit (yyy) over the alarm delay time.	

8.4.2 Technical Alarm Messages

Alarm Message	Source	Cause	Countermeasure
Medium Level			
**Battery Low	Monitor	The battery power is too low to support further work of the monitor.	Connect the monitor to AC power supply.
Low Level			
Check Paper	Monitor	There is no paper in the paper drawer or the drawer is open.	Load paper and/ or close the drawer.
US1 UNPLUGGED or US2 UNPLUGGED	US	US transducer 1 or US transducer 2 is not well connected.	Check the connection of the transducer.
US1 SIGNAL LOSS or US2 SIGNAL LOSS	US	FHR1 or FHR2 signal is too weak for the system to analyze.	Check if the US transducer is aimed at the fetal heart; check if the alarm limits are suitable; check the patient's condition.
Fetus EQUIP MALF	US	The fetus board can not communicate with the system successfully.	Restart the monitor and try again, contact the manufacturer if the connection still fails.
TOCO UNPLUGGED	TOCO	TOCO transducer is not well connected.	Check the connection of the transducer.

DECG LEADS OFF	DECG	The spiral electrode is not well connected.	Check the connection of the spiral electrode.
DECG UNPLUGGED	DECG	The DECG lead is not well connected to the monitor.	Check the connection of the DECG cable.
DECG SIGNAL LOSS	DECG	DECG signal is too weak for the system to analyze.	Check if the spiral electrode is well attached to the fetus; check the patient's condition.
DECG EQUIP MALF	DECG	The DECG board can not communicate with the system successfully.	Restart the monitor and try again, contact the manufacturer if the connection still fails.
Signals Overlap (FHR1, FHR2)	US	US transducer 1 and US transducer 2 are aimed at the same fetal heart; the signals overlap.	Adjust one of the US transducers until another fetal heart signal is detected.
Signals Overlap (DFHR, FHR2)	US + DECG	US transducer 1 is aimed at the fetus that the spiral electrode is attached to; the signals overlap.	Adjust the US transducer until another fetal heart signal is detected.

Chapter 9 Maternal Monitoring (F6 Express)

WARNING

- 1 Do not apply it during electro-surgery or MRI; otherwise it might result in harming the patient or the operator.
- 2 Always check if the alarm settings are appropriate for your patient before starting monitoring.
- 3 Check for any fault of the transducers before applying them to the patient.

NOTE:

This feature is only available on **F6 Express**.

9.1 Maternal ECG Monitoring

9.1.1 Introduction

ECG monitoring produces a continuous wave form of the patient's cardiac electric activity to enable an accurate assessment of current physiological state. Only proper connection of ECG cables can ensure a satisfactory measurement.

The parts needed are ECG lead and electrodes.

A 20-second monitor stabilization period shall be allowed before testing. The monitor has Tall T-wave rejection capability.

The response time of heart rate meter to change in heart rate is less than 10s.

The minute heart rate display is updated at an interval of 1s.

The monitor does not have capability of detecting or rejecting pacemaker pulse, nor does it provide a pulse to synchronize a defibrillator discharge.

The monitor does not give alarm for tachycardia.

The d.c. offset voltage tolerance of the monitor is from -500mV to +500mV. If the d.c. offset voltage of the detected ECG signal is out of this range, the monitor issues a high level alarm: ECG SIGNAL EXCEEDS LIMIT.

WARNING

- 1 When connecting the cables and electrodes, make sure no conductive part is in contact with the ground. Verify that all ECG electrodes, including neutral electrodes, are securely attached to the patient.
- 2 The electrodes should be made of the same metal materials.

CAUTION

A different type of electrodes may produce higher offset voltage. Therefore, only use the ECG leads supplied by the manufacturer when using the monitor for ECG monitoring.

NOTE:

Interference from a non-grounded instrument near the patient and ESU interference can cause inaccuracy of the waveform.

A good ECG signal should be –

- 1) With normal QRS wave.
- 2) Tall and narrow with no notches.
- 3) With tall R-wave completely above the baseline.
- 4) With T-wave less than one-third of the R-wave height.
- 5) With P-wave much smaller than the T-wave.

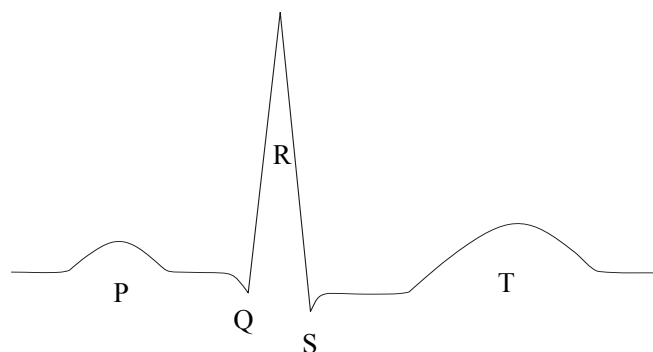

Figure 9-1 Standard ECG Waveform

9.1.2 How to Place 3-lead ECG Cables

The table below lists the names and position of 3-lead ECG cable in America and Europe.

America		Europe		Position
Name	Color	Name	Color	
RA	White	R	Red	Near the right shoulder, right below the clavicle
LA	Black	L	Yellow	Near the left shoulder, right below the clavicle
LL	Red	F	Green	On the left hypogastrium

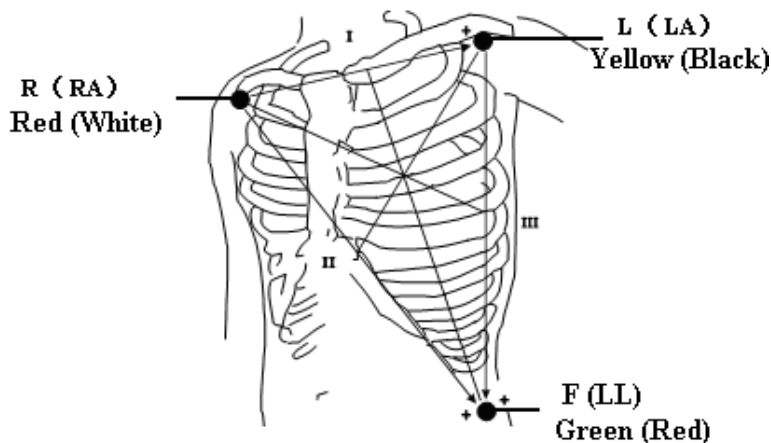

Figure 9-2 Placing 3-lead ECG Cable

NOTE:

- 1 To ensure patient's safety, all leads must be attached to the patient.
- 2 Check everyday if the skin is irritated from attachment of electrodes, if so, change for new electrodes or change their sites every 24 hours.
- 3 Recycle or dispose the used electrodes properly to protect the environment.

9.1.3 ECG Monitoring Procedure

- 1) Prepare the skin for ECG monitoring. Refer to section 7.3.3 *Preparing the Patient's Skin Prior to Placing Electrodes*.
- 2) Insert the ECG cable connector into the MECG socket on the monitor.
- 3) Connect attachment pad electrodes with an ECG cable.
- 4) Peel the protection membrane off the back of attachment pad electrodes and attach electrodes to the patient. Refer to section 9.1.2 *How to Place 3-lead ECG Cables* for electrodes' sites.

NOTE:

After the monitor is switched on, if electrodes are not well attached or fell off, alarm message "ECG LEADS OFF" will appear on the screen to draw your attention.

9.1.4 Changing ECG Source

Refer to figure 9-2, the ECG signal can come from channel I, II or III. In the ECG trace area of the main interface, **ECG (II, X1)** indicates the ECG source and gain.

If the electrodes are tightly attached to the patient but ECG waveform is not accurate, switch ECG source to another lead by performing the following procedures:

- 1 Select the setup key  on the main interface.
- 2 Select **Mother > Lead**.
- 3 Select **I, II** (default) or **III**.
- 4 Select **OK**.

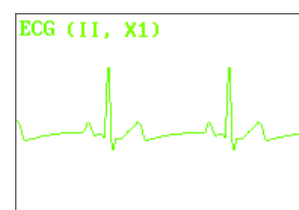

9.1.5 Changing ECG Gain

You can change the ECG gain. The ECG gain affects overall numeric and scope of the ECG waveform.

- 1 Select the setup key  on the main interface.
- 2 Select **Mother > Gain**.
- 3 Select **X1/4, X1/2, X1** (default), **X2** or **Auto**.
 'Auto' means the monitor adjusts the gain automatically. The system displays a 1mv scale at the left side of the ECG waveform. The height of 1mv bar is directly proportional to the waveform amplitude.
- 4 Select **OK**.

9.1.6 Enabling ECG Calibration

When windage of the ECG waveform is suspected, enable ECG calibration to validate the wave.

- 1 Select the setup key  on the main interface.
- 2 Select **Mother > ECG Calibration**.
- 3 Select **Calibration** or **OFF** (default).
- 4 Select **OK**.

The monitor creates a square wave in the ECG area. Compare the square wave with the ECG gauge. If the error is larger than 0.5mm, change the ECG gain.

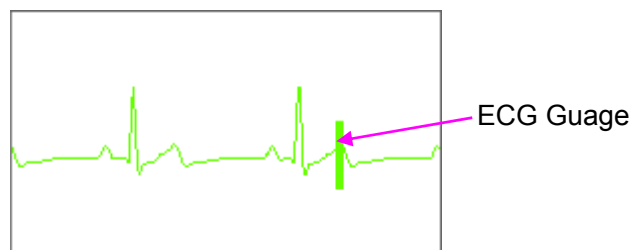

When the error is smaller than 0.5mm, calibration is completed. Disable ECG calibration in the same directory.

9.2 Maternal SpO₂ Monitoring

9.2.1 Introduction

The monitor provides continuous monitoring of functional arterial oxygen saturation (SpO₂) and pulse rate for pregnant women.

SpO₂ Plethysmogram measurement is employed to determine the oxygen saturation of hemoglobin in the arterial blood. If, for example, 97% hemoglobin molecules in the red blood cells of the arterial blood combine with oxygen, then the blood has a SpO₂ oxygen saturation of 97%. The SpO₂ numeric on the monitor will read 97%. The SpO₂ numeric shows the percentage of hemoglobin molecules which have combined with oxygen molecules to form oxyhemoglobin. The SpO₂/PLETH parameter can also provide a pulse rate signal and a plethysmogram wave.

The monitor is compatible with the SpO₂ transducers supplied by the manufacturer only, and the provided SpO₂ transducer can only be used with this monitor.

Compatibility should be checked prior to use. Otherwise the monitor performance can be degraded.

They all have been tested and found to comply with the limits for medical device in IEC/EN60601-1-2 (International standard for EMC testing of Medical Electrical Equipment, second edition). These limits are designed to provide reasonable protection against harmful interference in typical medical installation.

WARNING

- 1 Do not put the SpO₂ sensor on the extremities with arterial catheter or venous syringe.
 - 2 Do not perform SpO₂ measuring and NIBP measuring on the same arm at one time, because obstruction of blood flow during NIBP measuring may adversely affect the reading of SpO₂ numeric.
 - 3 Prolonged and continuous monitoring may increase jeopardy of unexpected change of dermal condition such as abnormal sensitivity, rubescence, vesicle, repressive putrescence, and so on. It is especially important to check the sensor placement of neonate and patient of poor perfusion or immature dermogram by light collimation and proper attaching strictly according to changes of the skin.
 - 4 The maximum application time of the SpO₂ sensor at a single site is 4 hours. Check the sensor placement every 2 to 3 hours and move it when the skin deteriorates. More frequent examinations may be required for different patients.
 - 5 Setting the SpO₂ higher alarm limit to 100% is equivalent to switching off the alarm on higher limit. High oxygen levels may predispose a premature infant to retrolental fibroplasia. Therefore, the higher alarm limit for oxygen saturation must be carefully selected in accordance with commonly accepted clinical practices.
-
-

CAUTION

Compatibility between the monitor and transducer should be verified before use to avoid injuring the patient or operator.

NOTE:

- 1 The monitor is calibrated to display functional oxygen saturation.
- 2 A functional tester cannot be used to assess the accuracy of the SpO₂ transducer or the monitor.
- 3 If there is independent demonstration that the particular calibration curve is accurate for the combination of a pulse oximeter monitor and a pulse oximeter transducer, then a functional tester can measure the contribution of a monitor to the total error of a monitor/ transducer system. The functional tester can then measure how accurately a particular pulse oximeter monitor is reproducing that calibration curve.
- 4 The device has no alarm condition delay and alarm signal generation delay.

Measurement Limits -

In operation, the accuracy of oximetry readings can be affected by:

- 1) Magnetic resonance imaging (MRI) scanning. Induced current could potentially cause burns.
- 2) Excessive patient movement.
- 3) Low perfusion.
- 4) High-frequency electrical noise, including noise created by the host system, or noise from external sources, such as electrosurgical apparatus, which is admitted by the host system.

- 5) Intravascular dye injections.
- 6) Improper sensor application.
- 7) Sensor temperature. (Maintain the temperature between +28 °C (+82.4 °F) and +41 °C (+105.8 °F) for best operation)
- 8) Placement of the sensor, such as on an extremity that has a NIBP cuff, arterial catheter, or intravascular line.
- 9) Significant concentrations of dysfunctional hemoglobin, such as carboxyhemoglobin and methemoglobin.
- 10) External illumination more than 5,000 lumens/square meter (typical office lighting). (Cover the sensor site with opaque materials is recommended.)
- 11) Venous pulsations.

To use the sensor:

- a) Select an appropriate sensor. Use an SpO₂ transducers approved by the manufacturer.
- b) Apply the sensor as directed, and observe all warnings and cautions presented in the sensor user manual.
- c) Clean and remove any substances, such as nail polish, from the application site.
- d) Periodically check to ensure that the sensor remains properly positioned on the patient.
- e) Cover the sensor site with opaque material.

9.2.2 SpO₂ Monitoring Procedure

- 1) Insert the SpO₂ transducer plug into the SpO₂ socket on the monitor.
- 2) Place the forefinger, middle finger or third finger into the SpO₂ sensor, refer to figure 9-3.

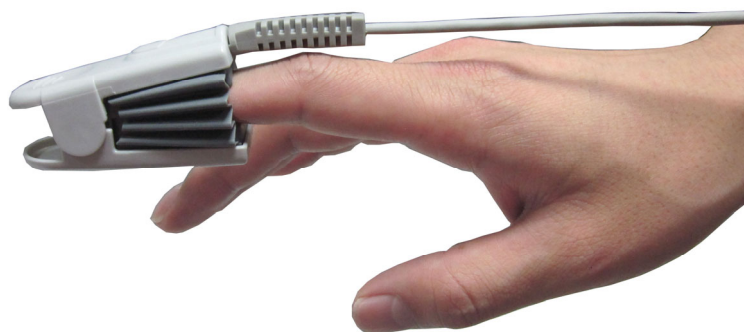

Figure 9-3 Placement of the Finger for SpO₂ Measuring

NOTE:

- 1 The nail should cover the light but not too long.
- 2 The cable should be placed on the backside of the hand.
- 3 Avoid external light sources such as radiated rays or ultrared rays.

9.2.3 Enabling SpO₂ Trace Printing

The real-time SpO₂ measurement result is displayed in the parameter area of the main interface. You can choose to print them as a continuous trace on the recorder paper (refer to figure 5-1).

To enable or disable SpO₂ trace printing,

- 1 Select the setup key  on the main interface.
- 2 Select **Recorder > SpO₂ Trace**.
- 3 Select **ON** or **OFF** (default).
- 4 Select **OK**.

9.2.4 Switching the SpO₂ Alarm On or Off

You can choose to switch the SpO₂ alarm on or off.

- 1 Select the setup key  on the main interface.
- 2 Select **Alarm > SpO₂ > Alarm**.
- 3 Select **ON** (default) or **OFF**.
- 4 Select **OK**.

9.2.5 Changing SpO₂ Alarm Limits

You can change the SpO₂ alarm limits.

- 1 Select the setup key  on the main interface.
- 2 Select **Alarm > SpO₂**.
- 3 Select a value from 50 ~ 99 for **Low Alarm Limit**.
- 4 Select a value from 51 ~ 100 for **High Alarm Limit**.
- 5 Select **OK**.

9.3 Maternal HR Monitoring

9.3.1 Introduction

Maternal heart rate (HR) monitoring does not need an extra accessory. When you perform ECG or SpO₂ (Pulse) monitoring, the HR result can be acquired at the same time.

When monitoring ECG and SpO₂ at the same time, you can choose the HR source. If only one of them is being performed, the source will automatically switch to the available one (the screen reading should prevail).

9.3.2 Choosing HR Source

You can change the HR source.

- 1 Select the setup key  on the main interface.
- 2 Select **Mother > HR Source**.
- 3 Select **ECG** (default) or **Pulse**.
- 4 Select **OK**.

9.3.3 Changing HR Beep Volume

When the HR beep is enabled, the monitor gives a beep sound of maternal heart.

To change the HR beep volume,

- 1 Select the setup key  on the main interface.
- 2 Select **Mother > HR Beep**.
- 3 Select **OFF** (default), **Low** or **High**.
- 4 Select **OK**.

NOTE:

Once the HR beep volume is changed, the sound switches to channel 1 automatically. Therefore, it is advised against changing HR beep volume in the monitoring process.

9.3.4 Enabling HR Trace

The real-time HR measurement result is displayed in the parameter area of the main interface. Also, you can choose to display and print those as a continuous trace on the recorder paper (refer to figure 5-1).

To enable or disable HR trace,

- 1 Select the setup key  on the main interface.
- 2 Select **Recorder > HR Trace**.
- 3 Select **ON** or **OFF** (default).
- 4 Select **OK**.

9.3.5 Switching the HR Alarm On or Off

You can choose to switch the HR alarm on or off.

- 1 Select the setup key  on the main interface.
- 2 Select **Alarm > HR > Alarm**.
- 3 Select **ON** (default) or **OFF**.
- 4 Select **OK**.

9.3.6 Changing HR Alarm Limits

You can change the HR alarm limits.

- 1 Select the setup key  on the main interface.
- 2 Select **Alarm > HR**.
- 3 Select a value from 30 ~ 239 for **Low Alarm Limit**.
- 4 Select a value from 31 ~ 240 for **High Alarm Limit**.
- 5 Select **OK**.

9.3.7 Signals Overlap Verification

When monitoring maternal heart rate and fetal heart rate at the same time, there are possibilities that maternal HR signal is mistaken for FHR signal. The SOV function of the monitor can also reduce these possibilities.

In the process of monitoring, if the SOV detects signals overlapping, an alarm message “Signals Overlap (FHR1/FHR2, HR)” will appear on the screen to warn you. Checking the patient and reposition of transducers might be needed.

9.4 Maternal NIBP Monitoring

9.4.1 Introduction

The monitor measures blood pressure using the oscillometric method.

There are two modes available: Manual and Auto. In manual mode, NIBP is measured once on each demand. In auto mode, NIBP is measured repeatedly after a preset time interval. This interval is adjustable. You can perform a manual measurement during an Auto measurement interval.

In both modes, systolic pressure (SYS), diastolic pressure (DIA) and mean artery pressure (MAP) are measured and displayed.

NOTE:

The mean artery pressure (MAP) is NOT available in the USA.

WARNING

- 1 Check for any fault of the cuff before start monitoring.
 - 2 Do not perform NIBP measurements on patients with sickle-cell disease or under any condition where the skin is damaged or expected to be damaged.
 - 3 If liquid is splashed on or into the main unit inadvertently, or enters the conduit, stop using the monitor and contact the manufacturer for service immediately.
 - 4 For a thrombocytopenia patient, it is important to determine whether the measurement of blood pressure shall be done automatically. The determination should be based on clinical evaluation.
-

NOTE:

The monitor is intended to measure NIBP for adults only.

Measurement Limitations -

To different patient conditions, the oscillometric measurement has certain limitations. The measurement is in search of regular arterial pressure pulse. In those circumstances where the patient's condition makes it difficult to detect, the measurement becomes unreliable and the measuring time increases. You should be aware that the following conditions could interfere with the measurement, making the measurement unreliable or longer to derive. In some cases, the patient's condition will make a measurement impossible.

1) Patient Movement

Measurements will be unreliable or may not be possible if the patient is moving, shivering or having convulsions. These motions may interfere with the detection of the arterial pressure pulses. In addition, the measurement time will be prolonged.

2) Cardiac Arrhythmia

Measurements will be unreliable and may not be possible if the patient's cardiac arrhythmia has caused an irregular heartbeat. The measuring time thus will be prolonged.

3) Heart-lung Machine

Measurements will not be possible if the patient is connected to a heart-lung machine.

4) Pressure Changes

Measurements will be unreliable and may not be possible if the patient's blood pressure is changing rapidly over the period of time during which the arterial pressure pulses are being analyzed to obtain the measurement.

5) Severe Shock

If the patient is in severe shock or hypothermia, measurements will be unreliable since reduced blood flow to the peripheries will cause reduced pulsation of the arteries.

6) Heart Rate Extremes

Measurements can not be done to a patient whose heart rate is lower than 40 bpm or higher than 240 bpm.

9.4.2 How to Apply NIBP Cuff

1) Select appropriate cuff for the patient.

The width of the cuff should be either 40% of the limb perimeter or 2/3 of the upper arm length. The inflatable part should be long enough to encircle 50% ~ 80% of the limb.

The table below lists the reference size:

Type	Limb Perimeter	Cuff Size	Air Hose Length
Upper Arm (Adult 1)	25 cm ~ 35 cm	14 cm	1.5 m or 3 m
Upper Arm (Adult 2)	33 cm ~ 47 cm	17 cm	

Thigh (Adult)	46 cm ~ 66 cm	21 cm	
---------------	---------------	-------	--

- 2) Squeeze the cuff to discharge the air.
- 3) Apply the cuff to the patient; make sure that the symbol "Φ" is over the appropriate artery (Refer to figure 9-4). Ensure that the cuff is not wrapped too tightly around the limb. Excessive tightness may cause discoloration and eventual ischemia of the extremities.

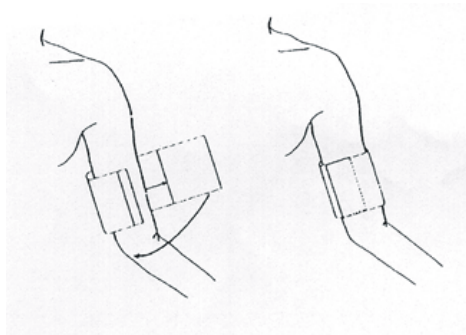

Figure 9-4 Applying the Cuff

9.4.3 Preparation for NIBP Monitoring

- 1) Insert the plug of the cuff extension tube into NIBP socket on the monitor.
- 2) Apply the NIBP cuff to the patient's arm or leg following the instructions described in section 9.4.2 *How to Apply NIBP Cuff*.
- 3) Connect the cuff to the extension tube. The limb chosen for taking the measurement should be placed at the same level as the patient's heart. If this is not possible, correct the measurement using the formula described in section 9.4.6 *Correcting the Measurement*.



Figure 9-5 Connection for NIBP Measurement

9.4.4 Auto Measurement

To perform an auto measurement

- 1 Select the setup key  on the main interface.
- 2 Select **Mother > Cycle**.
- 3 Select a time interval from 1, 2, 3, 4, 5, 10, 15, 30, 60, 90, 120, 180, 240 and 480 minutes.
- 4 Select **OK**.
- 5 Press **NIBP** key on the front panel to start an Auto measurement.

NOTE:

After the **NIBP** key is pressed, the system checks uterine pressure. If the pressure is higher than 50, it will automatically delay the NIBP measuring for 20 seconds.

To stop the current measurement

Press the **NIBP** key anytime during the current measurement to stop it. Another measurement will start after the time interval.

WARNING

Prolonged NIBP measurements in automatic mode may be associated with purport, ischemia and neuropathy in the limb wearing the cuff. When monitoring a patient, examine the extremities of the limb frequently for normal color, warmth and sensitivity. If any abnormality is observed, stop the NIBP measurement.

9.4.5 Manual Measurement

To perform a manual measurement,

- 1 Select the setup key  on the main interface.
- 2 Select **Mother > Cycle**.
- 3 Select **Manual**.
- 4 Select **OK**.
- 5 Press **NIBP** key on the front panel to start a manual measurement.

To stop the manual measurement,

Press the **NIBP** key anytime during the measurement to stop it.

To perform a manual measurement during an auto measurement interval,

- 1 Press the **NIBP** key to start the manual measurement.
- 2 Press the **NIBP** key again anytime to stop it.

The monitor will restart timing for the Auto measurement and resume measuring after the time interval.

NOTE:

- 1 If you are in doubt about the accuracy of any reading(s), check the patient's vital signs by an alternative method before checking the functioning of the monitor.
- 2 The monitor checks uterine contract (UC) pressure when the NIBP key is press. If the UC is over 50, a prompt "Intense UC, can't measure NIBP now." is issued. Please wait and do not attempt to measure NIBP until the UC is lower than 50.

CAUTION

If liquid is inadvertently splashed on the equipment or its accessories, or may enter the conduit or inside the monitor, contact local service center.

9.4.6 Correcting the Measurement

To correct the measurement if the limb is not at heart level,

- ◆ add 0.75 mmHg (0.10 kPa) for each inch higher.
- ◆ deduct 0.75 mmHg (0.10 kPa) for each inch lower.

9.4.7 Changing NIBP Unit

You can change the NIBP unit.

- 1 Select the setup key  on the main interface.
- 2 Select **Mother > Unit** (NIBP Setup).
- 3 Select **mmHg** (default) or **kPa**.
- 4 Select **OK**.

9.4.8 Switching the NIBP Alarm On or Off

You can choose to switch the NIBP alarm on or off. The SYS alarm and DIA alarm are related. Once one of them is switched off, the rest will be switched off as well.

- 1 Select the setup key  on the main interface.
- 2 Select **Alarm > SYS** or **DIA** or **MAP**.
- 3 Select **ON** (default) or **OFF**.
- 4 Select **OK**.

9.4.9 Changing SYS Alarm Limits

You can change the SYS alarm limits.

- 1 Select the setup key  on the main interface.
- 2 Select **Alarm > SYS**.
- 3 Select a value from 30 ~ 269 for **Low Alarm Limit**.
- 4 Select a value from 31 ~ 270 for **High Alarm Limit**.
- 5 Select **OK**.

9.4.10 Changing DIA Alarm Limits

You can change the DIA alarm limits.

- 1 Select the setup key  on the main interface.
- 2 Select **Alarm > DIA**.
- 3 Select a value from 10 ~ 244 for **Low Alarm Limit**.

- 4 Select a value from 11 ~ 245 for **High Alarm Limit**.
- 5 Select **OK**.

9.4.11 Changing MAP Alarm Limits

You can change the MAP alarm limits.

- 1 Select the setup key  on the main interface.
- 2 Select **Alarm > MAP**.
- 3 Select a value from 20 ~ 254 for **Low Alarm Limit**.
- 4 Select a value from 21 ~ 255 for **High Alarm Limit**.
- 5 Select **OK**.

9.4.12 Choosing NIBP Printing Mode

When the recorder is printing real-time fetal traces, the NIBP result is also recorded on the paper whenever NIBP measurement is performed. After the paper stops advancing, you can choose to keep recording NIBP results on the paper.

To enable or disable NIBP printing after paper advancing stops,

- 1 Select the setup key  on the main interface.
- 2 Select **Recorder > NIBP**.
- 3 Select **ON** or **OFF** (default).
- 4 Select **OK**.

NOTE:

The NIBP measurement results during the period of paper lacking and fast printing after new paper is loaded will not be saved or printed. Therefore, do not perform NIBP measurements during this period.

9.5 Maternal TEMP Monitoring

9.5.1 TEMP Monitoring Procedure

- 1) Insert the TEMP plug into the TEMP socket on the monitor.
- 2) Apply the sensor firmly underneath the patient's axilla.

WARNING

- 1 Check if the TEMP transducer functions properly prior to use.
 - 2 Do not apply the TEMP sensor to the mouth or the rectum.
-

CAUTION

Be cautious when taking and putting the TEMP transducer. Do not pull the cable too tight or it might cause mechanical damage.

9.5.2 Changing TEMP Unit

You can change the TEMP unit.

- 1 Select the setup key  on the main interface.
- 2 Select **Mother > Unit** (TEMP Setup).
- 3 Select °C (default) or °F.
- 4 Select **OK**.

9.5.3 Switching the TEMP Alarm On or Off

You can choose to switch the TEMP alarm on or off.

- 1 Select the setup key  on the main interface.
- 2 Select **Alarm > TEMP > Alarm**.
- 3 Select **ON** (default) or **OFF**.
- 4 Select **OK**.

9.5.4 Changing TEMP Alarm Limits

You can change the TEMP alarm limits.

- 1 Select the setup key  on the main interface.
- 2 Select **Alarm > TEMP**.
- 3 Select a value from 0.0 ~ 49.9 for **Low Alarm Limit**.
- 4 Select a value from 0.1 ~ 50.0 for **High Alarm Limit**.
- 5 Select **OK**.

Chapter 10 Maternal Monitoring Display (F6 Express)

10.1 Display Mode

F6 Express has three display modes: maternal-fetal display (figure 10-1), fetal display (figure 10-2) and maternal display (figure 10-3).

To change the display mode, select the display mode switch  on the main interface. The display mode will switch among the three modes.

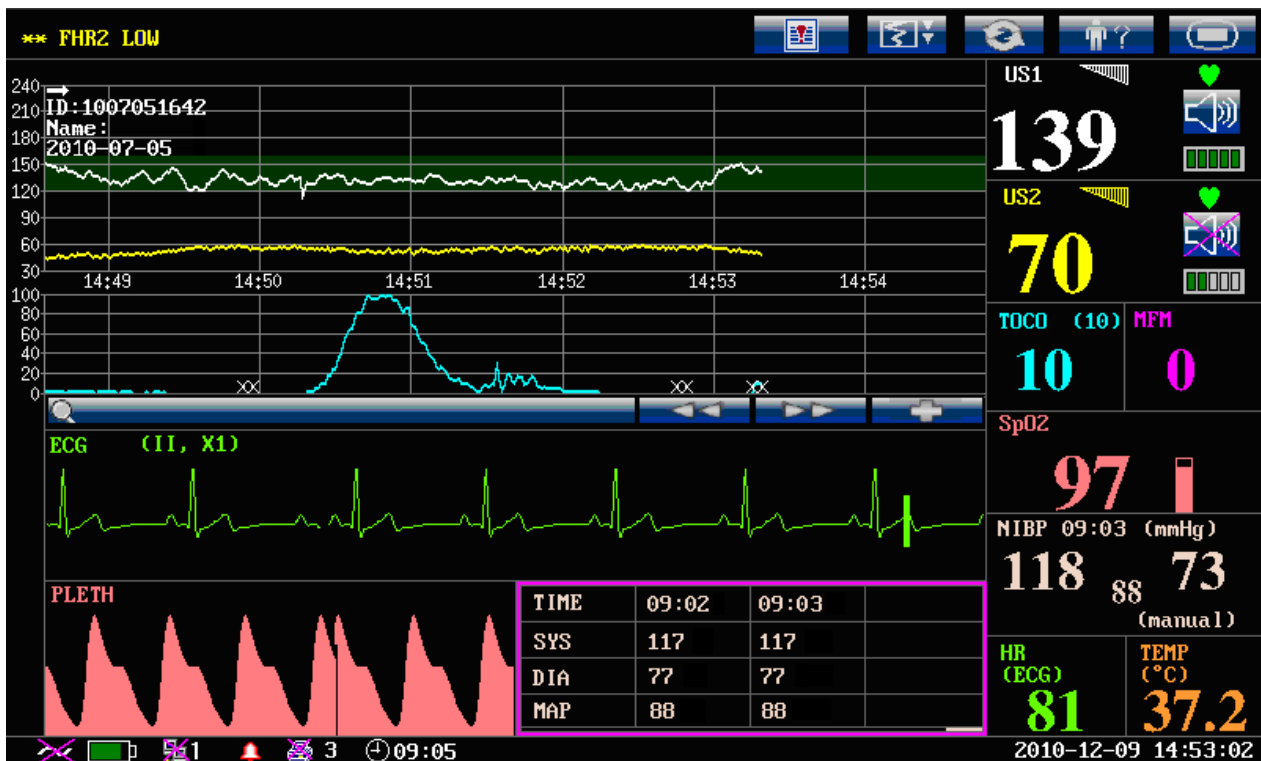

Figure 10-1 Maternal-Fetal Display mode

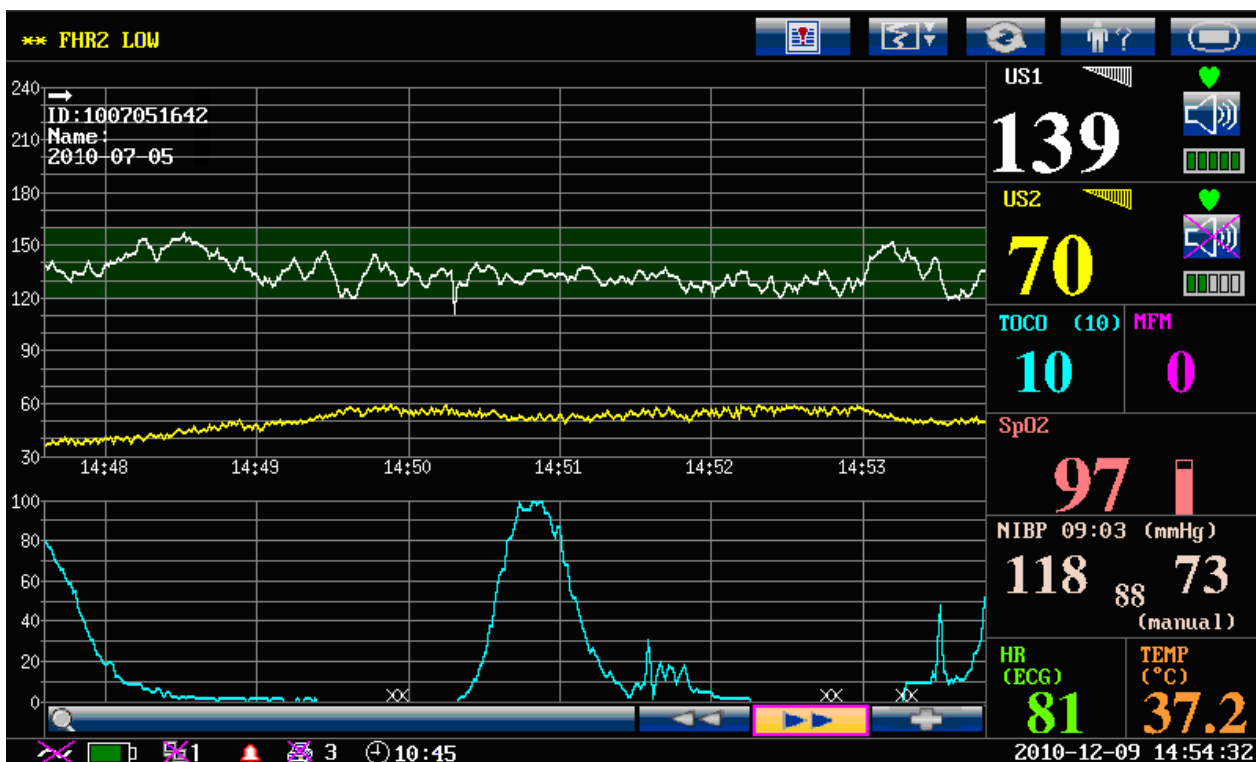

Figure 10-2 Fetal Display Mode

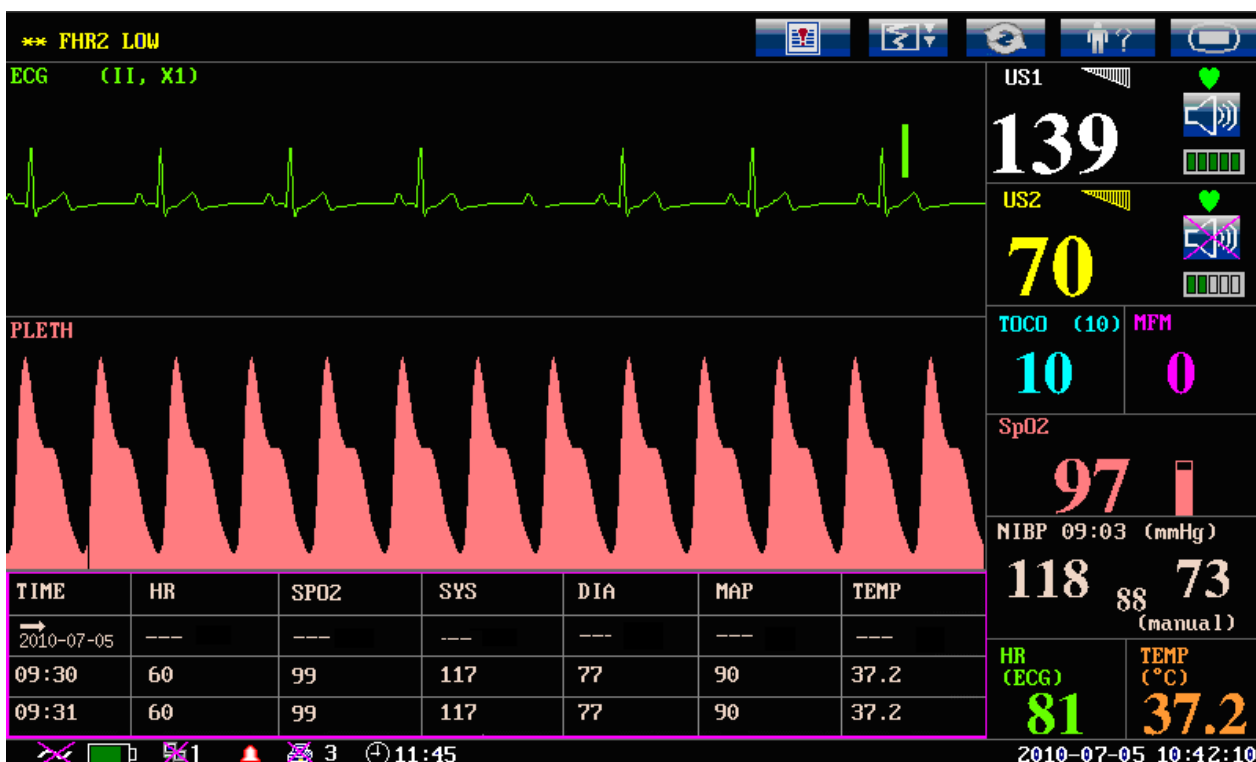

Figure 10-3 Maternal Display Mode

10.2 Maternal Monitoring Traces

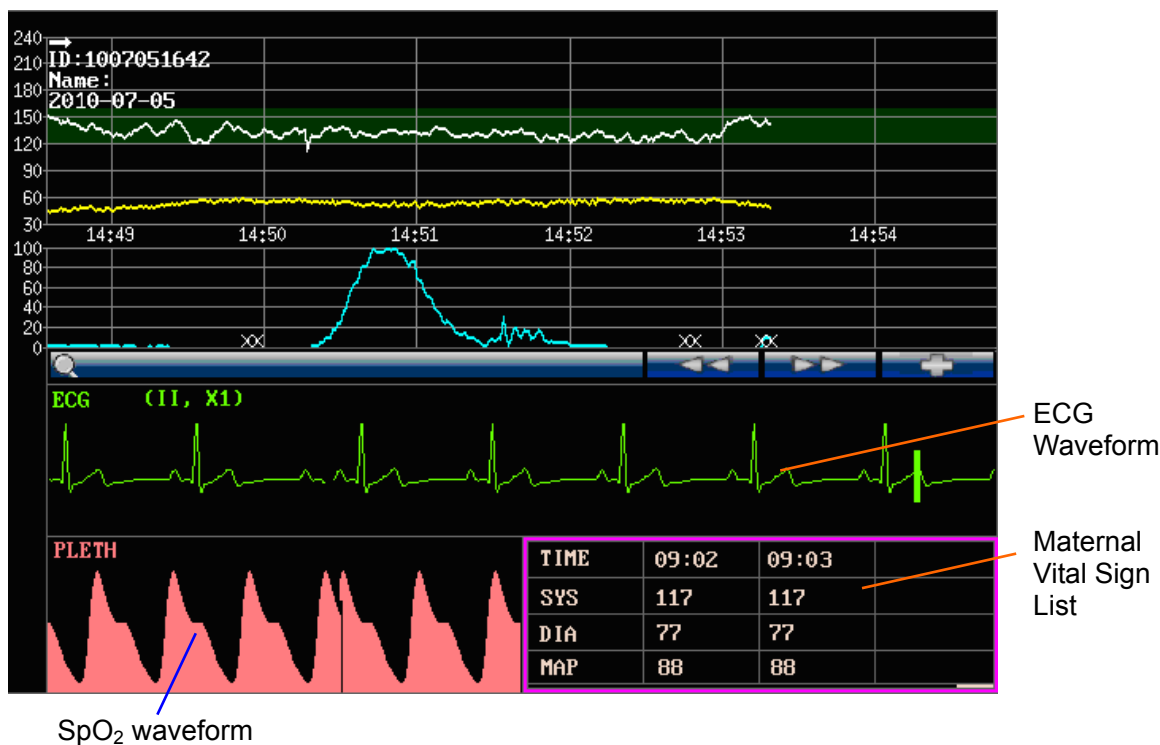

Figure 10-4 Maternal Monitoring Traces

F6 Express displays both maternal monitoring traces and fetal monitoring traces on the same screen. The maternal monitoring traces include ECG waveform and SpO₂ waveform. The fetal monitoring traces are the same as traces of **F6**, refer to *8.1 Fetal Monitoring Traces* for more information.

10.3 Maternal Vital Sign List

The maternal vital sign list keeps records of the recent maternal vital signs and the measuring time. A start mark → and the date appear when a new monitoring begins.

In maternal-fetal display mode, the list contains the time, SYS, DIA and MAP numerics of every measurement.

TIME	09:02	09:03	
SYS	117	117	
DIA	77	77	
MAP	88	88	

Figure 10-5 Maternal NIBP List

In maternal display mode, the list contains the time, HR, SpO₂, SYS, DIA, MAP and TEMP numerics. The numerics are recorded every minute.

TIME	HR	SPO2	SYS	DIA	MAP	TEMP
→ 2010-07-05	---	---	---	---	---	---
09:30	60	99	117	77	90	37.2
09:31	60	99	117	77	90	37.2

Figure 10-6 Maternal Vital Sign List

The maternal vital sign list can be reviewed: select the list and then rotate the control knob to review the previous lists.

10.4 Numerics

Besides the fetal numerics, the numeric window of **F6 Express** includes maternal vital signs: SpO₂, NIBP, HR and TEMP:

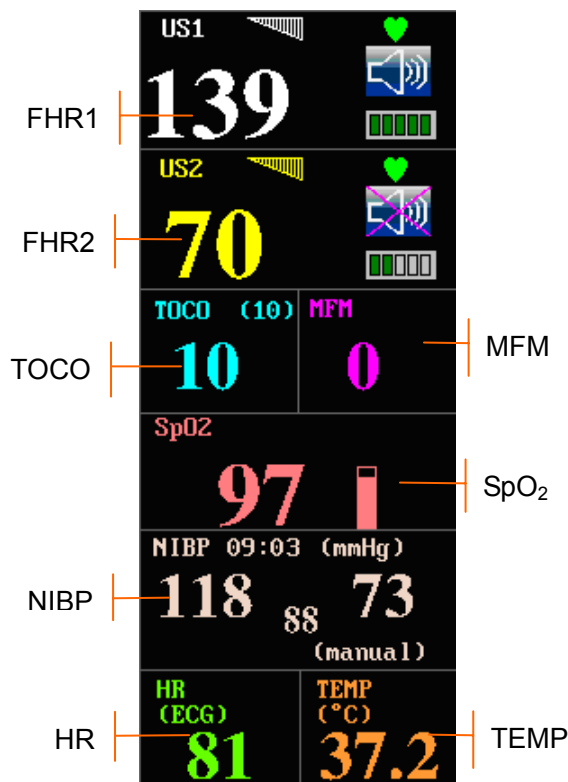





Figure 10-7 Numeric Window

<p>SpO₂ SpO₂ 97 </p>	<p>99: Current SpO₂ measurement numeric.</p> <p>: SpO₂ indicator.</p>
<p>NIBP NIBP 09:03 (mmHg) 118 88 73 (manual)</p>	<p>09:03: Time when the NIBP measurement starts.</p> <p>mmHg/kPa: NIBP unit.</p> <p>From left to right in turn: systolic pressure (118), mean artery pressure (88) and diastolic pressure (73).</p> <p>(manual)/(Auto, ...): The current NIBP measurement mode.</p>

 HR	(ECG)/(Pulse): The current HR source.
	81: Current maternal heart rate measurement numeric.
 TEMP	(°C)/(°F): TEMP unit.
	37.2: Current TEMP measurement numeric.

10.5 Maternal Monitoring Alarm Messages

Besides the fetal monitoring alarms, **F6 Express** also gives alarms for the situations that occur during maternal monitoring. The alarm messages are listed below.

10.5.1 Patient Alarm Messages

Alarm Message	Source	Cause	Countermeasure
High Level			
***ASYSTOLE	ECG	No QRS wave is detected in 4 seconds	Check the patient's condition and take necessary measures.
Medium Level			
**HR HIGH or **HR xxx > yyy	ECG/ Pulse	Maternal HR result (xxx) is higher than the upper limit (yyy).	Check if the alarm limits are suitable; check the patient's condition.
**HR LOW or **HR xxx < yyy	ECG/ Pulse	Maternal HR result (xxx) is lower than the upper limit (yyy).	
** SpO ₂ HIGH or ** SpO ₂ xxx > yyy	SpO ₂	SpO ₂ result (xxx) is higher than the upper limit (yyy).	
** SpO ₂ LOW or ** SpO ₂ xxx < yyy	SpO ₂	SpO ₂ result (xxx) is lower than the upper limit (yyy).	
**SYS HIGH or **SYS xxx > yyy	NIBP	SYS result (xxx) is higher than the upper limit (yyy).	
**SYS LOW or **SYS xxx < yyy	NIBP	SYS result (xxx) is lower than the upper limit (yyy).	
**DIA HIGH or **DIA xxx > yyy	NIBP	DIA result (xxx) is higher than the upper limit (yyy).	
**DIA LOW or **DIA xxx < yyy	NIBP	DIA result (xxx) is lower than the upper limit (yyy).	
**MAP HIGH or **MAP xxx > yyy	NIBP	MAP result (xxx) is higher than the upper limit (yyy).	
**MAPLOW or **MAP xxx < yyy	NIBP	MAP result (xxx) is lower than the upper limit (yyy).	
**TEMP HIGH or **TEMP xxx > yyy	TEMP	TEMP result (xxx) is higher than the upper limit (yyy).	
**TEMP LOW or **TEMP xxx < yyy	TEMP	TEMP result (xxx) is lower than the upper limit (yyy).	

10.5.2 Technical Alarm Messages

Alarm Message	Source	Cause	Countermeasure
High Level			
***ECG SIGNAL EXCEEDS LIMIT	ECG	ECG signal exceeds the measurement limits.	Check the connection of the leads and the patient's condition.
Low Level			
Signals Overlap (FHR1, HR)	US+ECG /Pulse	US transducer 1 has picked up the maternal heart signal; the signals overlap.	Reposition the US transducer 1 until the fetal heart signal is detected.
Signals Overlap (FHR2, HR)	US+ECG /Pulse	US transducer 2 has picked up the maternal heart signal; the signals overlap.	Reposition the US transducer 2 until the fetal heart signal is detected.
Signals Overlap (FHR1, FHR2, HR)	US+ECG /Pulse	US transducer 1 and US transducer 2 have picked up the maternal heart signal; the signals overlap.	Reposition the US transducers until the fetal heart signals are detected.
ECG LEADS OFF	ECG	ECG leads are not well connected.	Check the connection of ECG leads.
ECG SIGNAL LOSS	ECG	ECG signal is too weak for the system to analyze.	Check if the ECG leads are well attached; check the patient's condition.
ECG EQUIP MALF	ECG	The ECG board can not communicate with the system successfully.	Restart the monitor and try again, contact the manufacturer if the connection still fails.
HR EXCEEDS MEASUREMENT RANGE	ECG/ Pulse	The heart rate exceeds the measurement limits.	Check the connection of the ECG leads/SpO ₂ transducer and the patient's condition.
NIBP EQUIP MALF	NIBP	The NIBP board can not communicate with the system successfully.	Restart the monitor and try again, contact the manufacturer if the connection still fails.
NIBP SYSTEM FAILURE	NIBP	The NIBP module defective.	Restart the monitor and try again, contact the manufacturer if the connection still fails.
CUFF OVERPRESS	NIBP	The pressure has exceeded the specified upper safety limit.	Measure again, if failure persists, stop using the monitor for NIBP measuring and contact the manufacturer for service.

CUFF ERROR	TYPE	NIBP	A different cuff other than the one supplied by the manufacturer is used.	Use the cuff supplied by the manufacturer.
CUFF LEAK	TUBE	NIBP	The cuff, hose and (or) connector are (is) damaged.	Check and replace the leaking part(s). Contact the manufacturer for service if required.
NIBP LOSS	SIGNAL	NIBP	Cuff is too loose or the patient pulse is too weak.	Use other methods to measure NIBP.
EXCESSIVE MOTION		NIBP	Large signal noise or irregular pulse rate caused by excessive motions of the patient.	Keep the arm/leg that is wrapped with the cuff still.
NIBP EXCEEDS MEASUREMENT RANGE		NIBP	The blood pressure exceeds the measurement limits.	Check the connection of the cuff and the patient's condition.
NIBP TIME OUT		NIBP	Measuring time has exceeded 120 seconds.	Start measuring again, or use other measuring methods.
SpO ₂ LOW PERFUSION	LOW	SpO ₂	The signal received by SpO ₂ sensor is too weak, or the measurement part has low perfusion, and therefore the result may be inaccurate.	Check the patient's condition and reposition the SpO ₂ sensor. Contact the manufacturer for service if the problem persists.
SpO ₂ OFF	SENSOR	SpO ₂	SpO ₂ sensor is not well connected.	Check the connection of SpO ₂ sensor and finger placement.
SpO ₂ MALF	EQUIP	SpO ₂	The SpO ₂ board can not communicate with the system successfully.	Restart the monitor and try again, contact the manufacturer if the connection still fails.
TEMP UNPLUGGED		TEMP	TEMP transducer is not well connected.	Check the connection of TEMP transducer.

Chapter 11 After Monitoring

11.1 Completing Monitoring

After monitoring,

- 1) Remove transducers or electrodes from the patient; wipe the remaining gel off the patient and the transducer with a clean soft cloth or tissue.
- 2) Press the **PRINT** key to stop printing, and press the paper advancing key  to advance the paper.
- 3) Wait the paper to stop and then tear it off along the perforation.

NOTE:

After the fetus is delivered in the labor, the monitor may pick up signals of the umbilical cord and display a trace/numeric. To avoid misinterpretation, it is recommended to remove the transducers from the patient and switch off the monitor immediately after the fetus is delivered.

11.2 Switching Off

- 1) Press and hold the **POWER** switch for at least 3 seconds to switch off the monitor.
- 2) Unplug the power cord.

CAUTION

Do not press the **POWER** switch continuously. Allow at least 10 seconds between switching the monitor on and off.

Chapter 12 Maintenance and Cleaning

12.1 Maintenance

12.1.1 Maintaining Inspection

(1) Visual Inspection

Prior to using the monitor every time, do the following inspections:

- ◆ Check the monitor and accessories to see if there is any visible evidence of damage that may affect patient safety. Pay special attention to the cracks on the transducers and cables before immersing them into conductive fluid.
- ◆ Check all the outer cables, power socket and power cables.
- ◆ Check if the monitor functions properly.

If any damage is detected, stop using the monitor on the patient. Replace the damage part(s) or contact the manufacturer for service before reusing it.

(2) Routine Inspection

The overall check of the monitor, including safety check and function check, should be performed by qualified personnel every 6 to 12 months, and each time after service.

The equipment should undergo periodic safety testing to ensure proper patient isolation from leakage currents. This should include leakage current measurement and insulation testing. The recommended testing interval is once a year or as specified in the institution's test and inspection protocol.

(3) Mechanical Inspection

Make sure all exposed screws are tight.

Check the external cables for splits, cracks or signs of twisting.

Replace any cable that shows serious damage.

Pay particular attention to the supply socket.

WARNING

Failure on the part of the responsible individual hospital or institution employing the use of this equipment to implement a satisfactory maintenance schedule may cause undue equipment failure and possible health hazards.

CAUTION

Besides the maintenance requirements recommended in this manual, comply with local regulations on maintenance and measurement.

12.1.2 Maintenance of Monitor

Keep the exterior surface of the monitor clean, free of dust and dirt.

The gathering of dew on the screen may occur with abrupt temperature or humidity changes. A table environment is recommended. Stop using the monitor and contact the service personnel immediately if accidental wetting occurs.

Scratching and damaging the screen should be avoided.

12.1.3 Maintenance of Transducers

Keep the transducers in a dry environment, where the temperature had better be lower than +45°C (+115 °F).

Gel must be wiped from the US transducer after use. These precautions will prolong the life of the transducer.

Although transducers are designed for durability, they should be handled with care. Rough handling could damage the cover, piezoelectric crystals and mechanical movement. Contacting the transducers with hard or sharp objects should be avoided. Do not excessively flex the cables.

12.1.4 Storage of Recorder Paper

When storing recorder paper (including used paper with traces):

Do not store in plastic envelopes.

Do not leave exposed to direct sunlight or ultraviolet light.

Do not exceed a storage temperature of +40 °C (+104 °F).

Do not exceed a relative humidity of 80%.

Storage conditions outside these limits may distort the paper and adversely affect the accuracy of grid lines or make the trace unreadable.

12.1.5 Cleaning of Recorder

The recorder platen, thermal print head and paper sensing mechanism must be cleaned at least once a year or when needed (when traces become faint).

To do this:

- 1) Clean the recorder platen with a lint-free cloth dampened in soap/ water solution.
- 2) Wipe the thermal array using a cotton swab moistened with 70% Isopropyl alcohol-based solution.
- 3) Check that the paper sensing mechanism is free of dust.

WARNING

Switch off the monitor and remove the power cord prior to recorder cleaning.

12.1.6 Maintaining the Battery

It is required to follow the instructions in this user manual during installation, storage and maintenance of the battery.

When the battery is charged, used or stored, keep it away from objects or materials with static electric charges.

The recommended charge temperature range is from 0 °C (+32 °F) to +40 °C (+104 °F). Do not exceed this range.

When not using battery for an extended period, remove it from the monitor and store it in a place with low humidity and low temperature.

Batteries have life cycles. If the time that the monitor uses the battery becomes much shorter than usual, the battery life is at an end. Replace it with a new one the same as the one provided or recommended by the manufacturer.

12.2 Cleaning

In order to avoid infection, clean and disinfect the monitor and accessories after each use.

12.2.1 Cleaning of Monitor

Regular cleaning of the monitor enclosure and the screen is strongly recommended.

WARNING

- 1 Unplug the monitor from the AC power source and detach all accessories before cleaning. Do not immerse the unit in water or allow liquids to enter the case.
 - 2 If liquid is splashed on or into the main unit inadvertently, or enters the conduit, stop using the monitor and contact the manufacturer for service immediately.
-
-

The solutions recommended for monitor cleaning are: soft soap water, Tensides, Ethylate and Acetaldehyde.

Clean the monitor enclosure with soft cloth and diluent non-caustic detergents recommended above.

Clean the screen with a dry soft cloth.

CAUTION

- 1 Although the monitor is chemically resistant to most common hospital cleaners and non-caustic detergents, different cleaners are not recommended and may stain the monitor.
 - 2 Many cleansers must be diluted before use. Follow the manufacturer's directions carefully to avoid damaging the monitor.
 - 3 Do not use strong solvent, for example, acetone.
 - 4 Never use an abrasive such as steel wool or metal polish.
-
-

CAUTION

- 5 Do not allow any liquid to enter the product, and do not immerse any part of the monitor into any liquid.
- 6 Avoid pouring liquids on the monitor while cleaning.
- 7 Do not allow any remaining solution on the surface of the monitor.

NOTE:

- 1 The monitor surface can be cleaned with hospital-grade ethanol and dried in air or with crisp and clean cloth.
- 2 The manufacturer has no responsibility for the effectiveness of controlling infectious disease using these chemical agents. Please contact infectious disease experts in your hospital for details.

12.2.2 Cleaning of Accessories

(1) Cleaning of Transducers

To clean the transducers and leads, follow these steps:

- 1) Wipe them with a soft cloth dampened in cleaning solution;
- 2) Clean them with a soft cloth dampened in water;
- 3) Air-dry them or wipe the remaining moisture with a soft dry cloth.

The recommended cleansers for accessories are listed below:

Accessory	Cleansers
Ultrasound Transducer TOCO Transducer	BURATON LIQUID MIKROZID ETHANOL 70% SPORACIDIN CIDEX
DECG Leads	Mild alcohol-free soap water
IUP Cable	Mild alcohol-free soap water
ECG Leads	Mild soap water or ETHANOL 70%
SpO ₂ Transducer	Hospital-Grade Ethanol
TEMP Transducer	Hospital-Grade Ethanol

CAUTION

- 1 The waterproof parts of the transducer are restricted to the main body and the cable. Do not immerse the plug into water during the process of monitoring or cleaning.
- 2 Be sure the temperature of cleaning solutions does not exceed +45 °C (+113 °F).
- 3 Do not immerse them in any liquid.

CAUTION

- 4 Only clean the outer surface of the connectors, make sure no liquid goes into the connector.
- 5 After cleaning, no remaining cleanser is allowed on the surface.

(2) Cleaning of Belt

Wash soiled belts with soap and water. The water temperature must not exceed +60 °C (+140 °F).

(3) Cleaning of NIBP Cuff

The cuff can also be machine-washed or hand-washed. Hand-washing will prolong the life of the cuff.

Remove the latex rubber bag before washing; for machine-washing, close the Velcro fastening. Allow the cuff to dry thoroughly after washing; then reinsert the rubber bag.

Replace the Rubber Bag in the Cuff

To replace the rubber bag in the cuff, first place the bag on the top of the cuff so that the rubber tubes line up with the large opening on the long side of the cuff. Now roll the bag lengthwise and insert it into the opening on the long side of the cuff. Hold the tubes and the cuff and shake the complete cuff until the bag is in position. Thread the rubber tubes from inside the cuff, and out through the small hole under the internal flap.

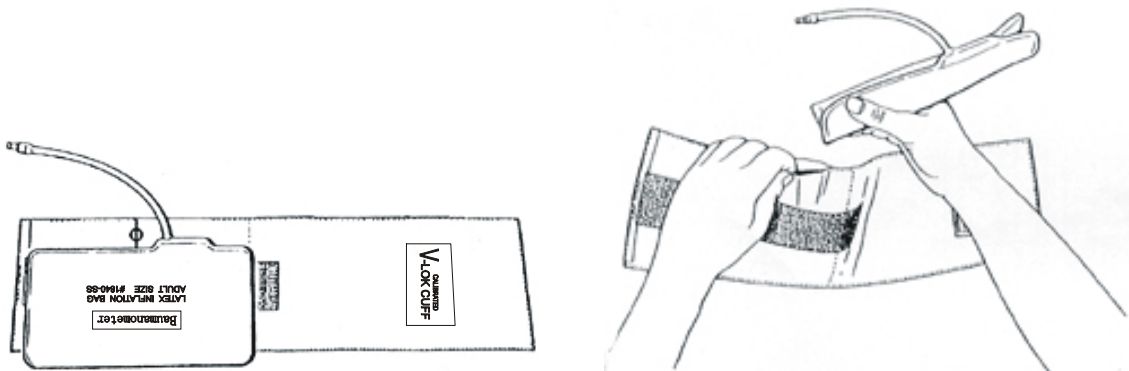

Figure 12-1 Replace the Rubber Bag in the Cuff

CAUTION

- 1 Do not squeeze the rubber tube on the cuff.
- 2 Do not dry-clean the cuff.
- 3 Only clean the outer surface of the connectors, make sure no liquid goes into the connector.
- 4 When the reusable cuff is not connected with the monitor, or being cleaned, always place the cover on the rubber tube to avoid liquid permeation.

12.3 Disinfecting

Clean the equipment before disinfecting.

The table below lists the allowed disinfectant bases:

Type	Ethylate	Acetaldehyde	Recommended
Transducers	√	√	Ethanol 70% Isopropanol 70%
DECG Cable	√	√	
IUP Cable	√	√	
ECG Leads	√	√	
SpO ₂ Transducer	√	√	
TEMP Transducer	√	√	

The recommended disinfectants for NIBP cuff are:

Cidex, Sporicidin, Microzid, Isopropyl-alcohol 70%, Ethanol 70% Buraton liquid.

CAUTION

- 1 Do not use any disinfectant containing additional active ingredients other than those listed.
- 2 Follow the manufacturer's instruction to dilute the solution, or adopt the lowest possible density.
- 3 Do not immerse any part of the monitor or any accessory into liquid.
- 4 After disinfection, no remaining disinfectant is allowed on the surface.
- 5 Check if the monitor and accessories are in good condition. If any aging or damage is detected (e.g. the belt loses its elasticity), replace the damage part(s) or contact the manufacturer for service before reusing them.

NOTE:

The manufacturer has no responsibility for the effectiveness of controlling infectious disease using these chemical agents. Please contact infectious disease experts in your hospital for details.

12.4 Sterilizing

Do not sterilize the monitor or the accessories, unless this is necessary according to your hospital regulation.

Chapter 13 Warranty and Service

13.1 Warranty

EDAN warrants that EDAN's products meet the labeled specifications of the products and will be free from defects in materials and workmanship that occur within warranty period.

The warranty is void in cases of:

- a) damage caused by mishandling during shipping.
- b) subsequent damage caused by improper use or maintenance.
- c) damage caused by alteration or repair by anyone not authorized by EDAN.
- d) damage caused by accidents.
- e) replacement or removal of serial number label and manufacture label.

If a product covered by this warranty is determined to be defective because of defective materials, components, or workmanship, and the warranty claim is made within the warranty period, EDAN will, at its discretion, repair or replace the defective part(s) free of charge. EDAN will not provide a substitute product for use when the defective product is being repaired.

13.2 Contact information

If you have any question about maintenance, technical specifications or malfunctions of devices, contact your local distributor.

Alternatively, you can send an email to EDAN service department at: support@edan.com.cn.

Appendix 1 Product Specifications

A1.1 Environmental Specifications

Working	Temperature:	+5 °C ~ + 40 °C (+41 °F ~ +104 °F)
	Relative Humidity:	25% ~ 80% (non-condensing)
	Atmospheric Pressure:	860hPa ~ 1060hPa
Transport and Storage	Temperature:	-20 °C ~ +55 °C (-4°F ~ +131 °F)
	Relative Humidity:	25% ~ 93% (non-condensing)
	Atmospheric Pressure:	700hPa ~ 1060hPa

A1.2 Physical Specifications

Monitor		
Dimensions and Weight	Size (depth x width x height):	347mm × 330mm × 126mm
	Weight:	F6: Approx. 5.3 kg F6 Express: Approx. 6.1 kg
Power Supply	Operating Voltage:	100V-240V~
	Operating Frequency:	50Hz/60Hz
	Input Power :	110VA
	Battery:	14.8V/4400mAh
Standards Compliance	IEC/EN 60601-1, IEC/EN 61157, IEC/EN 60601-2-37, IEC/EN 60601-1-2, IEC/EN 60601-2-30, EN 12470-4, IEC/EN 60601-2-49, IEC/EN 60601-2-27, EN ISO 9919	
Anti-electric Shock Type	Class I equipment with internal power supply	
Anti-electric Shock Degree	FHR1, FHR2, TOCO, FM, IUP	BF
	SpO ₂ , NIBP	BF (Defibrillating-proof)
	DECG	CF
	ECG, TEMP	CF (Defibrillating-proof)
Degree of Protection against Harmful Ingress of Water	Ordinary equipment (sealed equipment without liquid proof)	
Degree of Safety in Presence of Flammable Gases	Main Unit: Ordinary equipment (sealed equipment without liquid proof)	

	US/TOCO Transducers: IPX8 Other Accessories: No liquid ingress protection
Disinfection/Sterilizing Method:	Refer to this user manual for details
EMC	Group I Class A
Working System	Continuous running equipment
Display	
LCD Size:	10.1" (Diagonal)
Resolution:	800 × 3 (RGB) × 480
Display Mode:	Normally white, Transmissive
Pixel Pitch:	0.0925 mm(W) × 0.276 mm (H)
Active Area:	222.0 mm(W) × 132.48 mm (H)
Module Size:	235.0 mm(W) × 145.8 mm(H) × 6.1mm(D)
Surface treatment:	Anti-glare
Color Arrangement:	RGB-Stripe
Interface:	Digital
Viewing angle:	+/- 65° Horizontal, 45°/-65° Vertical
Response Time:	TrR = 15ms (typ.) / TrD = 20ms (Typ)
Contrast Ratio:	300:1 (Typ.)
Brightness:	350 cd/m2 (Typ.)
Backlight power consumption:	4.098W (Typ.)
Panel power consumption:	250mW (Typ.)
Weight:	332g ± 10%
Signal Interface	
RS232 interface (DB9 or D-Sub), RJ45 interface	
Ultrasound Transducer	
Cable Length:	2.5m
Weight:	190 g
Dimension:	88 mm × 35 mm

TOCO Transducer	
Cable Length:	2.5 m
Weight:	180 g
Dimension:	88 mm × 35 mm
Remote Event Marker	
Length:	2.5 m
Weight:	56 g
ECG	
Cable Length:	3 m
Weight:	213 g
SpO2	
Cable Length:	2.4 m
Weight:	68 g
NIBP	
Cable Length:	3.3 m
Weight:	194 g
TEMP	
Cable Length:	3 m
Weight:	55 g

A1.3 Performance Specifications

Ultrasound	Technique:	Ultrasound Pulse Doppler with autocorrelation
	Pulse Repetition Rate:	2 KHz
	Pulse Duration:	92 μs
	Ultrasound Frequency:	(1.0±10%) MHz
	p- <1 MPa	
	$I_{ob} < 10 \text{ mW/cm}^2$	
	$I_{spta} < 100 \text{ mW/cm}^2$	
	FHR Measurement Range:	50 bpm ~ 240 bpm
	Resolution:	1 bpm
	Accuracy:	±2 bpm
	Dielectric Strength:	> 4000Vrms

DECG	Technique:	Peak-peak detection technique
	DFHR Measurement Range:	30bpm ~ 240bpm
	Resolution:	1bpm
	Accuracy:	±1bpm
	Input Impedance:	> 10M (Differential, DC50/60Hz)
	Input Impedance:	> 20M (Common Mode)
	CMRR:	> 110dB
	Noise:	< 4μVp
	Skin Voltage Tolerance:	±500mV
	Fetal Input Voltage Current:	20μVp-3mVp
TOCO	TOCO Range:	0% ~ 100%
	Non-linear Error:	±10%
	Resolution:	1%
	Zero Mode:	Automatic/ Manual
	Dielectric Strength:	> 4000Vrms
IUP	Pressure Range:	0 ~ 100mmHg
	Sensitivity:	5μV/V/mmHg
	Non-linear Error:	± 3mmHg
	Resolution:	1%
	Zero Mode:	Automatic / Manual
AFM	Technique:	Pulsed Doppler ultrasound
	Range:	0% ~ 100%,
	Resolution:	1%
Marking	Manual fetal movement mark	
ECG	HR Measurement Range:	30 bpm ~ 240 bpm
	HR Measuring Accuracy:	±2 bpm
	ECG Waveform:	Manual control ECG waveform display
	ECG falls off:	Detect automatically
	Patient Leakage Current (Limit)	N.C. S.F.C. d.c. 10μA 50μA a.c. 10μA 50μA

ECG	Patient Auxiliary Current (Limit)	N.C. S.F.C. d.c. 10 μ A 50 μ A a.c. 10 μ A 50 μ A
	Differential Input Impedance	>5M Ω
	Display Sensitivity	2.5mm/mV ($\times 0.25$), 5mm/mV ($\times 0.5$), 10mm/mV ($\times 1$), 20mm/mV ($\times 2$), AUTO gain
	Sweep speed	25mm/s
	d.c. Offset Voltage Tolerance	± 500 mV
	Auxiliary Current (Leads off detection)	Active electrode: < 100 nA Reference electrode: < 900 nA
	Accuracy and Response to Irregular Rhythm	According with ANSI/AAMI EC13-2002 Sect.4.1.2.1 e) The HR value displays after a stable period of 20s: Ventricular bigeminy: 80bpm Slow alternating ventricular bigeminy: 60bpm Rapid alternating ventricular bigeminy: 120bpm Bidirectional systoles: 90bpm
	Response time to Change in HR	HR range: 80bpm ~ 120bpm Range: 7s ~ 8s (average: 7.5s) HR range: 80bpm ~ 40bpm Range : 7s ~ 8s (average: 7.5s)
	Accuracy of HR Alarm Limit	1 bpm
	Tall T-wave Rejection	Exceeds ANSI/AAMI EC13-2002 Sect. 4.1.2.1 (C) minimum recommended 1.2mV T-Wave amplitude
HR averaging method	Heart rate is computed by averaging the 12 most recent RR intervals.	
SpO2	Measurement Range:	50% ~ 100%
	Resolution:	1%
	Measuring Accuracy:	90% ~ 100% $\pm 2\%$ 70% ~ 90% $\pm 4\%$ < 70% unspecified
	Data Update Period:	2 seconds (typically) 10 seconds (in extreme condition)
	PR Measurement Range:	30 bpm ~ 240 bpm

SpO2	PR Measuring Accuracy:	± 2 bpm
	Data update period:	2 s
	Wave length	
	Red light	(660 \pm 3) nm
	Infrared light	(905 \pm 5) nm
	Emitted light energy	Not more than 15 mW
NIBP (for adult)	Measurement Range:	
	Systolic pressure:	40mmHg ~ 270mmHg
	Diastolic pressure:	10mmHg ~ 215mmHg
	Mean pressure:	20mmHg ~ 235mmHg
	Measuring Time:	≤ 120 seconds
	Software Over Voltage Limit:	≤ 297 mmHg
	Hardware Over Voltage Protection:	(325 \pm 10) mmHg
	Resolution:	1 mmHg
	Measuring Accuracy	
	Max. average deviation:	$\leq \pm 5$ mmHg
	Max. standard deviation:	≤ 8 mmHg
TEMP	Channel:	1
	Measurement Range:	0 °C ~ +50 °C
	Accuracy: (transducer error excluded)	0 °C ~ +25 °C: ± 0.2 °C +25 °C ~ +45 °C: ± 0.1 °C +45 °C ~ +50 °C: ± 0.2 °C
	Responding Time:	≤ 3 min
	Accessory:	TEMP transducer

A1.4 Recorder Specifications

Paper:	Z-fold, thermosensitive (compatible with GE and PHILIPS recorder paper)
Paper width:	152mm (GE), 150mm (PHILIPS)
Effective printing width:	110mm (American Standard) 120mm (International Standard)

FHR printout width:	70mm (American Standard) 80mm (International Standard)
FHR scaling:	30bpm/cm (American Standard) 20bpm/cm (International Standard)
TOCO printout width:	40mm
TOCO scaling:	25%/cm
Printing speed:	
Standard Speed (Real-Time Traces):	1 cm/min, 2 cm/min, 3 cm/min
Fast Print Speed (Stored Traces):	Up to 25mm/sec
Paper Advancing:	20mm/sec
Accuracy of data:	$\pm 5\%$ (X axis) $\pm 1\%$ (Y axis)
Resolution:	8 dots/mm
Record Information:	FHR1 trace/mark, FHR2 trace/mark, TOCO trace, AFM trace, fetal movement mark, event mark (and annotation), AUTO-zero symbol, date, time, printing speed, ID, name, FHR2 Offset, HR, SpO ₂ , SYS, DIA, MAP, TEMP, CTG analysis results etc.

A1.5 Rechargeable Lithium-ion Battery

Type:	Rechargeable Lithium-ion Battery
Continual Working Time:	2 hours ~ 4 hours (depending on the configuration)
Necessary Charge Time:	9 hours ~ 10 hours
Nominal Capacity:	4400mAh
Nominal Voltage:	14.8V
Charge Mode:	Constant current/ constant voltage
Charge Current (Standard):	0.2C ₅ A (880mA)
Charge Voltage (Standard):	(16.8 \pm 0.1) V
Maximum Continuous Charge Current:	2000mA

Storage Temperature:	Short Term (≤ 1 month): $-20\text{ }^{\circ}\text{C} \sim +60\text{ }^{\circ}\text{C}$ ($-4\text{ }^{\circ}\text{F} \sim +140\text{ }^{\circ}\text{F}$) Medium Term (≤ 3 months): $-20\text{ }^{\circ}\text{C} \sim +45\text{ }^{\circ}\text{C}$ ($-4\text{ }^{\circ}\text{F} \sim +113\text{ }^{\circ}\text{F}$) Long Term (≤ 1 year): $-20\text{ }^{\circ}\text{C} \sim +20\text{ }^{\circ}\text{C}$ ($-4\text{ }^{\circ}\text{F} \sim +68\text{ }^{\circ}\text{F}$) During storage, recharge the battery at least every six months.
Cycle Life:	≥ 500 times

A1.6 Low Output Summary Table

Low Output Summary Table

(for systems with no transducers having global maximum index values exceeding 1.0)

System: Fetal & maternal Monitor

Transducer Model	$I_{\text{spta.3}}$ (mW/cm^2)	TI Type	TI Value	MI	$I_{\text{pa.3@MI}_{\text{max}}}$ (W/cm^2)
PW1.0MHz	2.77	TIS	0.055	0.029	0.01
		TIB	0.629		

Appendix 2 Signal Input/Output Connector

Accessory equipment connected to these interfaces must be certified according to the respective IEC/EN standards (e.g. IEC/EN 60950 for data processing equipment and IEC/EN 60601-1 for medical equipment). Furthermore all configurations shall comply with the valid version of the system standard IEC/EN 60601-1-1. Anybody who connects additional equipment to the signal input connector or signal output connector to configure a medical system must ensure that the system complies with the requirements of the valid version of the system standard IEC/EN 60601-1-1. If in doubt, contact our technical service department or your local distributor.

DB9 Interface

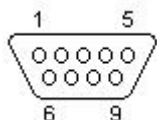

Pin	Signal	Input/Output
1	+5V	Output
2	Rx	Input
3	Tx	Output
4	485EN	Input
5	0V Ref.	
6	TA	Output
7	TB	Output
8	RA	Input
9	RB	Input

D-Sub Interface

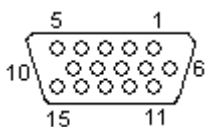

Pin	Signal	Input/Output
1	US2	Input
2	ISOCNS_RXD	Input
3	ISOCNS_TXD	Output
4	485EN	Input
5	0V Ref.	
6	TA	Output
7	TB	Output
8	RA	Input
9	RB	Input
10	DECG_SIGNAL	Input
11	US1	Input
12	+5V	Output
13	TOCO	Input
14	DECG_GND	
15	EN	Input

RJ45 Interface

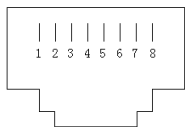

Pin	Signal	Input/Output
1	TD+	Output
2	TD-	Output
3	RD+	Input
4	Reserved	
5	Reserved	
6	RD-	Input
7	Reserved	
8	Reserved	

CAUTION

Only the PC or telemetry system recommended by the manufacturer can be connected to the signal input/output interface of the monitor. Other equipment is forbidden.

Appendix 3 Troubleshooting

A3.1 No Display

Phenomenon	Possible Cause	Solution
Power indicator is off.	Power cable is loose.	Tighten the power cable.
	The fuse is blown.	Change the fuse.
	The battery runs out of power.	Connect to AC power supply.

A3.2 Noise

Phenomenon	Possible Cause	Solution
Noise	Too high volume setup.	Turn down the volume.
	Interfered by mobile phone or other electromagnetic interference source.	Turn off or move the interference source.
		Move the monitor to a place with less interference.

A3.3 Recorder Error

Phenomenon	Possible Cause	Solution
Paper jam	Wrong loading paper or paper is dampened.	Load paper correctly and keep paper from moist.
Recorder does not work.	The recorder is not started.	Press the PRINT key.
	Run out of paper.	Load paper.
	The paper drawer is not locked.	Slide the paper drawer in until both latches are locked in position.

A3.4 Trouble with Ultrasound FHR Monitoring

Phenomenon	Possible Cause	Solution
Inconstant trace / display	The patient is overweighted.	Monitor FHR with DECG.
	Improper ultrasound transducer position.	Adjust the position of the transducer till the better signal is received.
	Loose belt.	Tighten the belt.
	Superfluous aquasonic coupling gel.	Wipe off superfluous aquasonic coupling gel.
	Frequent fetal movements.	Delay the monitoring.
	Maternal movement.	Request the patient to calm down and stay still.
	Inadequate aquasonic coupling gel.	Use recommended aquasonic coupling gel quantity.
Doubtful FHR	Record maternal heart rate wrongly.	Change the position of the ultrasound transducer.
	The transducer is not well placed in position, and the mixed noise has been recorded.	Adjust the position of the transducer.
Feint trace or no trace	Improper paper.	Use paper recommended by manufacturer
	The paper drawer is not locked.	Slide the paper drawer in until both latches are locked in position.
	Adjusting nuts of the print head are unbalanced.	Contact the manufacturer for service.

A3.5 Troubles with DECG FHR Monitoring

Phenomenon	Possible Cause	Solution
Inconstant trend Inconstant display	No ECG signal	Use a new spiral electrode
	Bad contact of reference electrode and patient	Use a new spiral electrode
Inconstant trend	The DECG cable has not been fixed firmly	Fix an attachment pad at the DECG cable.

A3.6 Troubles with Contractions Monitoring (External)

Phenomenon	Possible Cause	Solution
Bad trace quality or fluctuant TOCO baseline	The belt is too tight or too loose.	Adjust the belt.
	The belt has no elasticity.	Renew the belt.
	Maternal movement.	Request the patient to calm down and stay still.
	Frequent fetal movements.	Delay the monitoring.
Too high TOCO sensitivity (higher than 100 unit)	The body pressure from uterus to TOCO transducer is far higher than the average numeric.	Insure favorable contact for patient skin with TOCO transducer. Change the position of TOCO transducer, if necessary.

A3.7 Troubles with Monitoring Contractions (Internal)

Phenomenon	Possible Cause	Solution
No trend	The intrauterine catheter is jammed	Wash with disinfectant
No pressure change when uterine contraction	“Dry” environment or the tip of intrauterine catheter is placed extraovularly	Wash with disinfectant or change the position of transducer
Only see the IUP peak but no baseline	Zero adjustment is wrong	Zero the system
The trend is a beeline	The connector failure.	Move or contact catheter. If trend no fluctuation, change intrauterine cable.

A3.8 Big ECG Signal Interference or Thick Baseline

Phenomenon	Possible Cause	Solution
Big ECG signal interference or thick baseline	Abnormal electrodes placing or electrodes invalidation.	Check the electrodes placing and the period of validity of electrodes.
	The cable connector is not well connected.	Check the connection of cable connector.

	Power socket has no standard ground wire.	Check if power socket has standard ground wire.
	The special ground wire connecting with monitor is not properly earthed.	Check if the special ground wire connecting with monitor is earthed.

A3.9 NIBP and SpO₂ No Results

Phenomenon	Possible Cause	Solution
NIBP and SpO ₂ have no results	The NIBP cuff is not properly wrapped to the position of patient's arm.	Check if the NIBP cuff is properly wrapped to the position of patient's arm.
	The NIBP can not be inflated.	Extend catheter, and check the connection.
	Hose connector plug is not connected well with the NIBP socket.	Check if the hose connector plug is connected well with the NIBP socket.
	SpO ₂ transducer is not connected well with the SpO ₂ socket.	Check if the SpO ₂ transducer is connected well with the SpO ₂ socket.
	Abnormal working condition.	Shut off the power, then switch it on again.

A3.10 Blown Fuses

WARNING

Switch off the monitor and unplug it before changing the fuse.

Replace the fuse when it is blown.

The two fuses of the monitor are located on the bottom panel, their specifications are:

Size: $\Phi 5\text{mm} \times 20\text{mm}$; Model: T2AH250V.

To replace a fuse:

- 1 Fold the LCD display completely flat.
- 2 Carefully place the monitor upside down on a flat surface covered with cloth or other protecting pad.
- 3 With a flat-head screw driver, push the fuse in for about 1 mm and then unscrew it anticlockwise.
- 4 Remove the old fuse and replace it with a new fuse that is supplied by the manufacturer or of the same specifications.

- 5 Push the new fuse into the socket for about 1 mm and then screw it clockwise back in position.

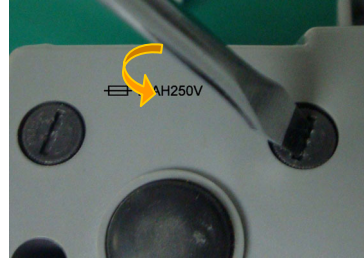
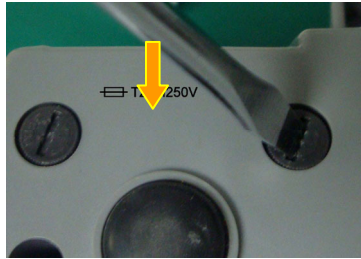

Appendix 4 Abbreviation

The abbreviations used in this manual and their full names are listed below:

Abbreviation	Full Name
AC	Alternative Current
AFM	Automatic Fetal Movement [Detection]
BPM	Beat(s) Per Minute
CTG	Cardiotocography
DC	Direct Current
DIA	Diastolic Blood Pressure
ECG	Electrocardiogram
FH	Fetal Heart
FHR	Fetal Heart Rate
FM	Fetal Movement
FS	Fetal Stimulator
HR	Heart Rate
ICU	Intensive Care Unit
ID	Identity
LCD	Liquid Crystal Display
MECG	Maternal ECG
MFM	Manual Fetal Movement [Detection]
MRI	Magnetic Resonance Imaging
NIBP	Non-Invasive Blood Pressure
NST	Non Stress Test
PR	Pulse Rate
SOV	Signals Overlap Verification
SpO ₂	Pulse Oximetry
SYS	Systolic Blood Pressure
TEMP	Temperature
TOCO	Tocotonometer
UA	Uterine Activity [TOCO]
US	Ultrasound [Transducer]

Appendix 5 EMC Information – Guidance and Manufacture’s Declaration

A5.1 Electromagnetic Emissions – for all EQUIPMENT and SYSTEMS

Guidance and manufacture’s declaration – electromagnetic emission		
The <i>F6/F6 Express Fetal & maternal Monitor</i> is intended for use in the electromagnetic environment specified below. The customer of the user of the <i>F6/F6 Express Fetal & maternal Monitor</i> should assure that it is used in such and environment.		
Emission test	Compliance	Electromagnetic environment – guidance
RF emissions CISPR 11	Group 1	The <i>F6/F6 Express Fetal & maternal Monitor</i> uses RF energy only for its internal function. Therefore, its RF emissions are very low and are not likely to cause any interference in nearby electronic equipment.
RF emission CISPR 11	Class A	The <i>F6/F6 Express Fetal & maternal Monitor</i> is suitable for use in all establishments, other than domestic and those directly connected to the public low-voltage power supply network that supplies buildings used for domestic purposes.
Harmonic emissions IEC 61000-3-2	Class A	
Voltage fluctuations/ flicker emissions IEC 61000-3-3	Complies	

A5.2 Electromagnetic Immunity – for all EQUIPMENT and SYSTEMS

Guidance and manufacture's declaration – electromagnetic immunity			
The <i>F6/F6 Express Fetal & maternal Monitor</i> is intended for use in the electromagnetic environment specified below. The customer or the user of <i>F6/F6 Express Fetal & maternal Monitor</i> should assure that it is used in such an environment.			
Immunity test	IEC 60601 test level	Compliance level	Electromagnetic environment - guidance
Electrostatic discharge (ESD) IEC 61000-4-2	± 6 kV contact ± 8 kV air	± 6 kV contact ± 8 kV air	Floors should be wood, concrete or ceramic tile. If floor are covered with synthetic material, the relative humidity should be at least 30%.
Electrical fast transient/burst IEC 61000-4-4	± 2 kV for power supply lines	± 2kV for power supply lines	Mains power quality should be that of a typical commercial or hospital environment.
Surge IEC 61000-4-5	± 1 kV line to line ± 2 kV line to ground	± 1 kV line to line ± 2 kV line to ground	Mains power quality should be that of a typical commercial or hospital environment.
Power frequency (50Hz/60Hz) magnetic field IEC61000-4-8	3 A/m	3 A/m	Power frequency magnetic fields should be at levels characteristic of a typical location in a typical commercial or hospital environment.

<p>Voltage dips, short interruptions and voltage variations on power supply input lines IEC 61000-4-11</p>	<p>< 5% U_T (> 95% dip in U_T) for 0.5 cycle</p> <p>40% U_T (60% dip in U_T) for 5 cycles</p> <p>70% U_T (30% dip in U_T) for 25 cycles</p> <p>< 5% U_T (> 95% dip in U_T) for 5 sec</p>	<p>< 5% U_T (> 95% dip in U_T) for 0.5 cycle</p> <p>40% U_T (60% dip in U_T) for 5 cycles</p> <p>70% U_T (30% dip in U_T) for 25 cycles</p> <p>< 5% U_T (> 95% dip in U_T) for 5 sec</p>	<p>Mains power quality should be that of a typical commercial or hospital environment. If the user of the <i>F6/F6 Express Fetal & maternal Monitor</i> requires continued operation during power mains interruptions, it is recommended that the <i>F6/F6 Express Fetal & maternal Monitor</i> be powered from an uninterruptible power supply or a battery.</p>
--	--	--	---

NOTE: U_T is the a.c. mains voltage prior to application of the test level.

A5.3 Electromagnetic Immunity – for EQUIPMENT and SYSTEM that are not LIFE-SUPPORTING

Guidance and manufacture's declaration – electromagnetic immunity			
The <i>F6/F6 Express Fetal & maternal Monitor</i> is intended for use in the electromagnetic environment specified below. The customer or the user of <i>F6/F6 Express Fetal & maternal Monitor</i> should assure that it is used in such an environment.			
Immunity test	IEC 60601 test level	Compliance level	Electromagnetic environment - guidance
Conducted RF IEC 61000-4-6	3 V _{rms} 150 kHz to 80 MHz	3 V _{rms}	<p>Portable and mobile RF communications equipment should be used no closer to any part of the <i>F6/F6 Express Fetal & maternal Monitor</i> including cables, than the recommended separation distance calculated from the equation applicable to the frequency of the transmitter.</p> <p>Recommended separation distance</p> $d = \left[\frac{3.5}{V_1} \right] \sqrt{P}$ $d = \left[\frac{3.5}{E_1} \right] \sqrt{P} \quad 80 \text{ MHz to } 800 \text{ MHz}$ $d = \left[\frac{7}{E_1} \right] \sqrt{P} \quad 800 \text{ MHz to } 2.5 \text{ GHz}$ <p>Where P is the maximum output power rating of the transmitter in watts (W) according to the transmitter manufacturer and d is the recommended separation distance in meters (m).</p> <p>Field strengths from fixed RF transmitters, as determined by an electromagnetic site survey,^{a)} should be less than the compliance level in each frequency range.^{b)}</p> <p>Interference may occur in the vicinity of equipment marked with the following symbol:</p> 
Radiated RF IEC 61000-4-3	3 V/m 80 MHz to 2.5 GHz	3 V/m	

NOTE 1: At 80 MHz and 800 MHz, the higher frequency range applies.

NOTE 2: These guidelines may not apply in all situations. Electromagnetic propagation is affected by absorption and reflection from structures, objects and people.

- a) Field strengths from fixed transmitters, such as base stations for radio (cellular/cordless) telephones and land mobile radios, amateur radio, AM and FM radio broadcast and TV broadcast cannot be predicted theoretically with accuracy. To assess the electromagnetic environment due to fixed RF transmitters, an electromagnetic site survey should be considered. If the measured field strength in the location in which the *F6/F6 Express Fetal & maternal Monitor* is used exceeds the applicable RF compliance level above, the *F6/F6 Express Fetal & maternal Monitor* should be observed to verify normal operation. If abnormal performance is observed, additional measures may be necessary, such as reorienting or relocating the *F6/F6 Express Fetal & maternal Monitor*.
- b) Over the frequency range 150 kHz to 80 MHz, field strengths should be less than 3 V/m.

A5.4 Recommended Separation Distance

Recommended separation distances between portable and mobile RF communications equipment and the F6/F6 Express Fetal & maternal Monitor

The F6/F6 Express Fetal & maternal Monitor is intended for use in an electromagnetic environment in which radiated RF disturbances are controlled. The customer or the user of the F6/F6 Express Fetal & maternal Monitor can help prevent electromagnetic interference by maintaining a minimum distance between portable and mobile RF communications equipment (transmitters) and the F6/F6 Express Fetal & maternal Monitor as recommended below, according to the maximum output power of the communications equipment.

Rated maximum output power of transmitter (W)	Separation distance according to frequency of transmitter (m)		
	150 kHz to 80 MHz $d = \left[\frac{3.5}{V_1} \right] \sqrt{P}$	80 MHz to 800 MHz $d = \left[\frac{3.5}{E_1} \right] \sqrt{P}$	800 MHz to 2.5 GHz $d = \left[\frac{7}{E_1} \right] \sqrt{P}$
0.01	0.12	0.12	0.23
0.1	0.37	0.37	0.73
1	1.2	1.2	2.3
10	3.7	3.7	7.3
100	12	12	23

For transmitters rated at a maximum output power not listed above, the recommended separation distance d in meters (m) can be estimated using the equation applicable to the frequency of the transmitter, where P is the maximum output power rating of the transmitter in watts (W) according to the transmitter manufacturer.

NOTE 1: At 80 MHz and 800 MHz, the separation distance for the higher frequency range applies.

NOTE 2: These guidelines may not apply in all situations. Electromagnetic propagation is affected by absorption and reflection from structures, objects and people.

Appendix 6 Limitations of Ultrasonic Monitoring

A6.1 How Does Ultrasound Work

When the ultrasound waves strike an object, they bounce back and create an echo. If the object moves toward the sound source, the frequency of the echo increases. If the object moves away from the sound source, the frequency of the echo decreases. This is called “Doppler Effect”. In the 1960's, the ultrasonic technique was first applied to medical diagnostic imaging.

The ultrasound process involves placing a small device called a transducer, against the skin of the patient near the region of interest. The ultrasound transducer combines functions of emitting and receiving ultrasounds in one device. This transducer produces a stream of inaudible, high frequency sound waves which penetrate into the body and bounce off the organs inside. It detects sound waves as they bounce off or echo back from the internal structures and contours of the organs. The movement of the organs produces the Doppler Effect, and this movement can be measured and described by measuring the echo.

In fetal monitoring, the ultrasound transducer produces a stream of sound waves which penetrate into the maternal abdomen and bounce off the fetal heart. Then the transducer receives the echoes and transfers them to the monitor, which turns the signal into fetal heart beating sound and fetal heart rate trace.

Therefore, placement of the transducer is critical to ultrasound fetal heart monitoring.

A6.2 Artifacts in Fetal Heart Monitoring

(1) How does artifact happen?

The transducer detects sound waves as they bounce off or echo back from the fetal heart. However, the sound waves bouncing off from maternal blood vessels may be detected by the transducer and then be processed by the monitor as well. As a result, artifacts may be produced.

The artifacts, if not correctly interpreted, may cause the physicians to perform unnecessary interventions, or to fail to detect the fetal distress and the need for interventions.

The most common artifacts are doubling and halving.

(2) Doubling:

When the FHR drops to 120 bpm or lower, the diastole and systole become far apart, thereby the monitor may mistake these two movements of a single heartbeat for two separate heartbeats. As a result, a heart rate trace that is double the actual heart rate is produced. This often happens during severe decelerations and bradycardia, representing an abrupt switch of the trace to double the actual heart rate.

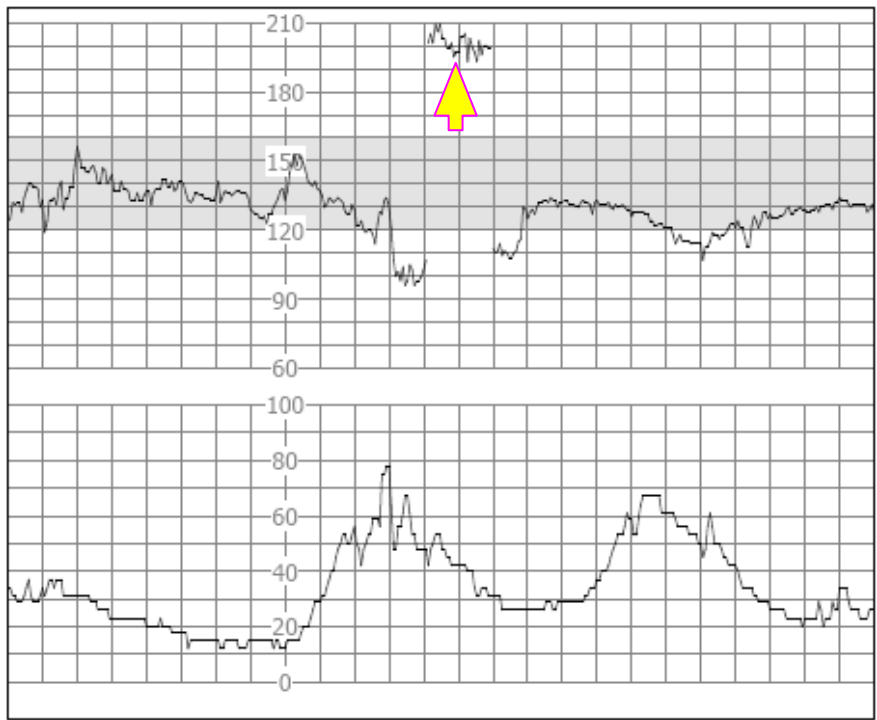

(3) Halving:

When the FHR increases to 180 bpm or higher, it is possible for the monitor to mistake the two separate heartbeats for the diastole and systole of a single heartbeat. As a result, a heart rate trace that is half the actual heart rate is produced. This often happens during tachycardia, representing an abrupt switch of the trace to half the actual heart rate. The clinicians may interpret it as a “deceleration”.

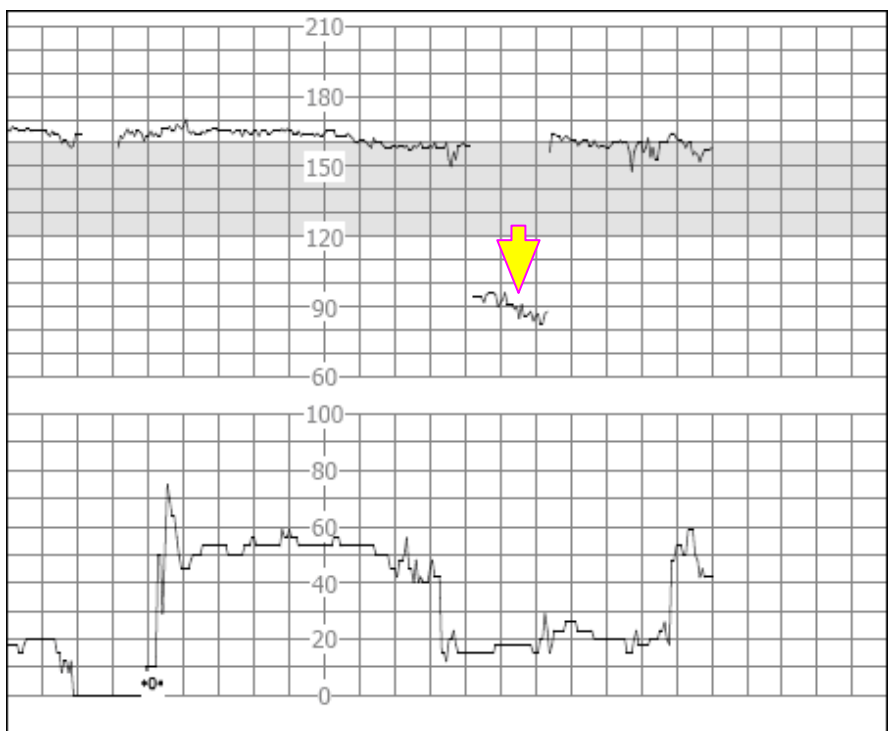

However, the heart beat sound from the monitor speaker is still reliable even when doubling or halving is occurring.

Stethoscopy should be applied when sudden changes in baseline are detected.

If the amniotic membrane rupture and cervical dilatation are sufficient, consider using a spiral electrode to obtain precise FHR with direct fetal ECG as the signal source.

(4) Erratic Traces / Drop out

When the fetal heart moves partially out of the ultrasound wave path, the transducer receives mixed or weak signals, and thereby the monitor presents erratic traces. When the fetal heart moves fully out of the path, inadequate consecutive and periodic signals are received, and no trace is represented.

Erratic traces and transitory episodes of drop out are common, especially when the fetus or/and mother move(s). If they exist for an extended period, it indicates that the transducer is not aimed at the fetus. Repositioning of the transducer is needed.

A6.3 Audio Output and Screen Reading

In most instances, the audio output from the monitor speaker corresponds to the readings presented on the monitor screen. But occasionally the fetal heart sound may differ from the trace and numeric.

When the fetal heart moves partially out of the ultrasound wave path, the transducer receives weaker FHR signal and other stronger signals (usually maternal heart/pulse rate). After the signals are transmitted to the monitor, the audio system and the video system of the monitor process the signals separately. On one hand, the audio circuit filters the low-frequency signals and gives audio output of the high-frequency signals, so fetal heart sound is heard. On the other hand, the autocorrelation algorithm computes the stronger signal source and thereby the maternal heart/pulse rate is displayed. As a result, the audio output differs from the screen reading.

If this situation occurs, it can be dismissed by repositioning the transducer.

In a word, the abnormalities listed above (artifacts, sound and reading differences) are caused by the limitations of ultrasonic monitoring technique. Fortunately they rarely occur. But a good understanding of how to detect them and what countermeasures should be taken will help obtain better fetal monitoring effect.

We hope you find this information useful. If you have any questions about fetal monitoring, please contact our sales representatives and perinatal specialists.

Appendix 7 Connection of T840 Telemetry System

The T840 telemetry system of Rimkus Medixintechnik is compatible for use with **F6** and **F6 Express**.

This appendix introduces how to connect the T840 telemetry system to **F6** and **F6 Express**, and how the monitors display the monitoring results.

The operation and maintenance of the T840 are described in OPERATOR’S MANUAL of T840 telemetry system. Reading through the manual will help you obtain the best possible results from the system.

A7.1 Connecting T840 Telemetry System

Examine the rear panel of the monitor, and make sure it is configured with a D-Sub concave interface.



In the accessory box, at least one of the following signal cables is provided. The signal cables are used to connect the receiver unit to the fetal monitor. They both have a D-Sub convex socket and a DB15 convex socket. Besides that, the Y-shape signal cable has an extra DB9 concave socket, which can be used for network connection of the monitor.



Figure A7-1 Signal Cable



Figure A7-2 Y-shape Signal Cable

① D-Sub Convex Socket

② DB15 Convex Socket

③ DB9 Concave Socket

Connection:

The following illustration shows how to connect the T840 telemetry system to **F6** and **F6 Express**.



Figure A7-3 Connection of T840 and F6/F6 Express

1. Put the D-Sub convex socket of the signal cable into the D-Sub interface of the monitor.
2. Put the DB15 convex socket of the signal cable into the DB15 interface of the receiver unit.

CAUTION

- 1 DECG cable shares the US1 channel with the telemetry system but has higher priority. Therefore, do not connect the DECG cable to the monitor when using the telemetry system.
- 2 Telemetry system and wired transducers are allowed to be connected to the monitor simultaneously, but the monitor reacts to the wireless signals preferentially. Once the cordless US transducer is placed in the storing place, the monitor automatically reacts to the wired transducers.

A7.2 FHR Monitoring with Cordless Transducers

FHR monitoring with cordless transducers:

- 1) Connect the receiver unit (as introduced in T840 operator's manual).
- 2) Switch on the monitor.
- 3) Take out the cordless transducers and apply them to the patient. Refer to T840 operator's manual and section 7.2.2/7.5.2 of this manual.

Once the cordless US transducer is taken out of the storing place, wireless signal indicators  are shown in the numeric area of the monitor. Other symbols have the same meanings as introduced in chapter 8 and chapter 10.

When the transducers detect the signals, numerics appear in the US1 and TOCO numeric area respectively.



NOTE:

- 1 If the measurement results from cordless transducers are dubious, wired transducers should be used and the clinical decision should be made basing on the wired system output.
- 2 The T840 telemetry system only provides one FHR channel (US1).
- 3 When performing underwater monitoring using cordless transducers, signal loss, interference and TOCO baseline drift may occur. Avoid pulsating water jets to reduce artificial traces.
- 4 When the US or TOCO signal loss occurs, the trace becomes broken. It is necessary to check the signal quality frequently.

P/N: 01.54.109276-15

EDANUSA
www.edanusa.com

4901 Morena Blvd., Suite 505
San Deigo, CA 92117
Tel: 888.850.4597