

# EDAN

## **iM50/iM60/iM70/iM80**

Patient Monitor

Version 1.3

---

**CE**<sub>0123</sub>

# About this Manual

P/N: 01.54.455711-13

Release Date: April 2014

© Copyright EDAN INSTRUMENTS, INC. 2012-2014. All rights reserved.

## Statement

This manual will help you understand the operation and maintenance of the product better. It is reminded that the product shall be used strictly complying with this manual. User's operation failing to comply with this manual may result in malfunction or accident for which EDAN INSTRUMENTS, INC. (hereinafter called EDAN) cannot be held liable.

EDAN owns the copyrights of this manual. Without prior written consent of EDAN, any materials contained in this manual shall not be photocopied, reproduced or translated into other languages.

Materials protected by the copyright law, including but not limited to confidential information such as technical information and patent information are contained in this manual, the user shall not disclose such information to any irrelevant third party.

The user shall understand that nothing in this manual grants him, expressly or implicitly, any right or license to use any of the intellectual properties of EDAN.

EDAN holds the rights to modify, update, and ultimately explain this manual.

## Responsibility of the Manufacturer

EDAN only considers itself responsible for any effect on safety, reliability and performance of the equipment if:

Assembly operations, extensions, re-adjustments, modifications or repairs are carried out by persons authorized by EDAN, and

The electrical installation of the relevant room complies with national standards, and

The instrument is used in accordance with the instructions for use.

Upon request, EDAN may provide, with compensation, necessary circuit diagrams, and other information to help qualified technician to maintain and repair some parts, which EDAN may define as user serviceable.

## Terms Used in this Manual

This guide is designed to give key concepts on safety precautions.

### **WARNING**

A **WARNING** label advises against certain actions or situations that could result in personal injury or death.

### **CAUTION**

A **CAUTION** label advises against actions or situations that could damage equipment, produce inaccurate data, or invalidate a procedure.

### **NOTE**

A **NOTE** provides useful information regarding a function or a procedure.

# Table of Contents

<b>Chapter 1 Intended Use and Safety Guidance .....</b>	<b>1</b>
1.1 Intended Use.....	1
1.2 Safety Guidance .....	2
1.3 Explanation of Symbols on the Monitor .....	5
<b>Chapter 2 Installation .....</b>	<b>9</b>
2.1 Initial Inspection.....	9
2.2 Mounting the Monitor .....	9
2.2.1 Installing Wall Mount for the Monitor .....	9
2.3 Connecting the Power Cable .....	9
2.4 Checking Out the Monitor .....	9
2.5 Checking the Recorder .....	10
2.6 Setting the Date and Time .....	10
2.7 Handing Over the Monitor .....	10
2.8 FCC Statement* .....	10
2.9 FCC RF Radiation Exposure Statement* .....	11
<b>Chapter 3 Basic Operation .....</b>	<b>12</b>
3.1 Overview .....	12
3.1.1 Front View .....	12
3.1.2 Rear View .....	15
3.1.3 Side View .....	19
3.1.4 Configuration .....	21
3.2 Operating and Navigating .....	21
3.2.1 Using Keys .....	23
3.3 Operating Mode .....	24
3.3.1 Demo Mode.....	24
3.3.2 Standby Mode .....	25
3.3.3 Night Mode .....	25
3.4 Changing Monitor Settings .....	25
3.4.1 Adjusting Screen Brightness .....	25
3.4.2 Changing Date and Time.....	26
3.5 Adjusting Volume .....	26
3.5.1 Adjusting Key Volume .....	26
3.5.2 Adjusting Alarm Volume .....	26
3.5.3 Adjusting Beat Volume.....	26
3.6 Checking Your Monitor Version .....	26
3.7 Networked Monitoring.....	26
3.8 Setting Languages .....	27
3.9 Understanding Screens.....	27
3.10 Calibrating Screens .....	27
3.11 Disabling the Touch Screen.....	27
3.12 Using the Barcode Scanner .....	28
3.13 Resolving IBP Label Conflicts.....	28
<b>Chapter 4 Alarms .....</b>	<b>29</b>
4.1 Alarm Category .....	29
4.1.1 Physiological alarms .....	29
4.1.2 Technical Alarms.....	29

4.1.3 Prompts .....	29
4.2 Alarm Levels .....	29
4.3 Controlling Alarm .....	30
4.3.1 Setting Parameter Alarm .....	30
4.3.2 Temporary Alarm Mute .....	31
4.3.3 Alarm Mute .....	32
4.3.4 Controlling Alarm Volume .....	32
4.4 Latching Alarms .....	32
4.5 Disabling Sensor Off Alarms .....	32
4.6 Testing Alarms.....	33
<b>Chapter 5 Alarm Information.....</b>	<b>34</b>
5.1 Physiological Alarm Information.....	34
5.2 Technical Alarm Information .....	39
5.3 Prompts .....	51
5.4 Adjustable Range of Alarm Limits.....	53
<b>Chapter 6 Managing Patients .....</b>	<b>58</b>
6.1 Admitting a Patient.....	58
6.1.1 Patient Category and Paced Status .....	58
6.2 Quick Admit.....	59
6.3 Editing Patient Information.....	59
6.4 Updating a Patient.....	59
6.5 Central Monitoring System.....	59
<b>Chapter 7 User Interface .....</b>	<b>61</b>
7.1 Setting Interface Style .....	61
7.2 Selecting Display Parameters.....	61
7.3 Changing Waveform Position .....	61
7.4 Changing Interface Layout.....	61
7.5 Viewing Trend Screen .....	61
7.6 Viewing Oxygen Screen.....	62
7.7 Viewing Large Font Screen.....	62
7.8 Viewing the Bed View Window .....	63
7.8.1 Opening the Bed View Window.....	63
7.8.2 Settings of the Bed View Window .....	63
7.9 Changing Parameter and Waveform Colors.....	63
7.10 User Configuration.....	63
7.11 Default Configuration .....	64
<b>Chapter 8 Monitoring ECG .....</b>	<b>65</b>
8.1 Overview .....	65
8.2 ECG Safety Information .....	65
8.3 ECG Display .....	66
8.3.1 Changing the Size of the ECG Wave .....	66
8.3.2 Changing the ECG Filter Settings.....	67
8.4 Using ECG Alarms.....	67
8.5 Selecting Calculation Lead .....	67
8.6 Monitoring Procedure .....	68
8.6.1 Preparation .....	68
8.6.2 Connecting ECG Cables .....	68
8.7 Selecting Lead Type.....	68

8.8	Installing Electrodes.....	69
8.8.1	Electrode Placement for 3-lead.....	69
8.8.2	Electrode Placement for 5-lead.....	71
8.8.3	Electrode Placement for 12-lead.....	72
8.8.4	Recommended ECG Lead Placement for Surgical Patients.....	73
8.9	ECG Menu Setup.....	74
8.9.1	Setting Alarm Source.....	74
8.9.2	Smart Lead Off.....	74
8.9.3	Setting Beat Volume.....	74
8.9.4	ECG Display.....	75
8.9.5	Setting Pace Status.....	75
8.9.6	ECG Calibration.....	75
8.9.7	ECG Waveform Settings.....	75
8.9.8	12 Leads ECG.....	76
8.10	ST Segment Monitoring.....	76
8.10.1	Setting ST Analysis.....	76
8.10.2	ST Display.....	76
8.10.3	ST Analysis Alarm Setting.....	76
8.10.4	About ST Measurement Points.....	77
8.10.5	Adjusting ST and ISO Measurement Points.....	77
8.11	Arr. Monitoring.....	77
8.11.1	Arrhythmia Analysis.....	77
8.11.2	ARR Analysis Menu.....	79
8.12	12-Lead ECG Monitoring.....	80
8.12.1	Diagnosis Function.....	80
8.12.2	Measurement and Interpretation.....	81
<b>Chapter 9</b>	<b>Monitoring RESP.....</b>	<b>82</b>
9.1	Overview.....	82
9.2	RESP Safety Information.....	82
9.3	Resp Display.....	83
9.4	Electrode Placement for Monitoring Resp.....	83
9.5	Cardiac Overlay.....	83
9.6	Chest Expansion.....	83
9.7	Abdominal Breathing.....	84
9.8	Selecting Resp Lead.....	84
9.9	Changing Hold Type.....	84
9.10	Changing the Size of the Respiration Wave.....	84
9.11	Using Resp Alarms.....	84
9.12	Changing the Apnea Time.....	84
<b>Chapter 10</b>	<b>Monitoring SpO<sub>2</sub>.....</b>	<b>85</b>
10.1	Overview.....	85
10.2	SpO <sub>2</sub> Safety Information.....	85
10.3	Measuring SpO <sub>2</sub> .....	86
10.4	Measurement Procedure.....	86
10.5	Understanding SpO <sub>2</sub> Alarms.....	87
10.6	Adjusting Alarm Limits.....	87
10.7	Setting SpO <sub>2</sub> as Pulse Source.....	87
10.8	Setting Pitch Tone.....	87
10.9	Setting Sensitivity.....	88

<b>Chapter 11 Monitoring PR</b> .....	<b>89</b>
11.1 Overview .....	89
11.2 Setting PR Source.....	89
11.3 Setting PR Volume .....	89
11.4 Using Pulse Alarms .....	89
11.5 Selecting the Active Alarm Source.....	89
<b>Chapter 12 Monitoring NIBP</b> .....	<b>90</b>
12.1 Overview .....	90
12.2 NIBP Safety Information .....	90
12.3 Introducing the Oscillometric NIBP Measurement.....	91
12.4 Measurement Limitations.....	91
12.5 Measurement Methods .....	92
12.6 Measurement Procedures .....	92
12.7 Operation Prompts .....	93
12.8 Correcting the Measurement if Limb is not at Heart Level .....	93
12.9 NIBP Alarm.....	94
12.10 Resetting NIBP.....	94
12.11 Calibrating NIBP.....	94
12.12 Leak Test .....	94
12.12.1 Procedure of Leak Test.....	94
<b>Chapter 13 Monitoring TEMP</b> .....	<b>96</b>
13.1 Overview .....	96
13.2 TEMP Safety Information .....	96
13.3 TEMP Monitoring Setup .....	96
13.4 Calculating Temp Difference .....	96
<b>Chapter 14 Monitoring Quick TEMP*</b> .....	<b>97</b>
14.1 Overview .....	97
14.2 Quick TEMP Safety Information .....	97
14.3 Measuring Procedure .....	98
14.3.1 Measurement for Oral Temperature .....	98
14.3.2 Measurements for Rectal Temperatures .....	99
14.3.3 Measurements for Axillary Temperatures .....	99
14.4 Changing Temp Unit .....	100
<b>Chapter 15 Monitoring IBP</b> .....	<b>101</b>
15.1 Overview .....	101
15.2 IBP Safety Information .....	101
15.3 Monitoring Procedures.....	101
15.4 Selecting a Pressure for Monitoring.....	102
15.5 Zeroing the Pressure Transducer .....	102
15.6 Zeroing a Pressure Measurement.....	103
15.7 Troubleshooting the Pressure Zeroing (Taking Art for Example).....	103
15.8 IBP Pressure Calibration .....	103
15.9 Troubleshooting the Pressure Calibration .....	104
15.10 IBP Alarm.....	105
<b>Chapter 16 Monitoring CO<sub>2</sub></b> .....	<b>106</b>
16.1 Overview .....	106

16.2 CO <sub>2</sub> Safety Information.....	106
16.3 Monitoring Procedures.....	107
16.3.1 Zeroing the sensor.....	107
16.3.2 Sidestream CO <sub>2</sub> Module.....	107
16.3.3 Mainstream CO <sub>2</sub> Module.....	109
16.4 Setting CO <sub>2</sub> Waveform Setup.....	111
16.5 Setting CO <sub>2</sub> Corrections.....	111
16.6 Changing CO <sub>2</sub> Alarms.....	112
16.7 Changing the Apnea Alarm Delay.....	112
<b>Chapter 17 Monitoring C.O.....</b>	<b>113</b>
17.1 Overview.....	113
17.2 C.O. Safety Information.....	113
17.3 C.O. Monitoring Procedures.....	113
17.4 C.O. Measurement Window.....	114
17.5 Measurement Process.....	116
17.6 Editing C.O.....	117
17.7 Blood Temperature Monitoring.....	117
17.8 Setting the Computation Constant.....	118
17.9 Recording C.O. Measurements.....	118
17.10 Setting INJ. TEMP Source.....	118
17.11 Setting the Interval.....	118
<b>Chapter 18 Monitoring AG.....</b>	<b>119</b>
18.1 Overview.....	119
18.2 Safety Information.....	119
18.2.1 Safety Information for ISA Analyzer.....	119
18.2.2 Safety Information for IRMA Module.....	121
18.3 Monitoring Steps.....	122
18.3.1 Monitoring Steps for ISA Analyzer.....	122
18.3.2 Monitoring Steps for IRMA Module.....	124
18.4 Setting Work Mode.....	127
18.5 Setting Alarms.....	128
18.6 Setting Apnea Alarm Time.....	128
18.7 Working Status of ISA analyzer.....	128
18.8 Working Status of IRMA Module.....	128
18.9 N <sub>2</sub> O and O <sub>2</sub> Compensations.....	129
18.10 Effects of humidity.....	129
<b>Chapter 19 Freeze.....</b>	<b>130</b>
19.1 Overview.....	130
19.2 Entering/Exiting Freeze Status.....	130
19.2.1 Entering Freeze Status.....	130
19.2.2 Exiting Freeze Status.....	130
19.3 Reviewing Frozen Waveform.....	131
<b>Chapter 20 Review.....</b>	<b>132</b>
20.1 Trend Graph Review.....	132
20.1.1 Selecting Trend Graph of Specific Parameter.....	132
20.1.2 Adjusting Trend Scale.....	132
20.1.3 Setting Resolution.....	133
20.1.4 Scrolling Left and Right the Screen.....	133



20.1.5 Switching to the Trend Table .....	133
20.1.6 Record .....	133
20.2 Trend Table Review .....	133
20.2.1 Setting Resolution .....	133
20.2.2 Scrolling the Screen .....	133
20.2.3 Switching to Trend Graph .....	134
20.2.4 Recording .....	134
20.3 NIBP Review .....	134
20.3.1 Scrolling the Screen .....	134
20.3.2 Recording .....	134
20.4 Alarm Review .....	134
20.4.1 Scrolling the Screen .....	134
20.4.2 Selecting Alarm Event of Specific Parameter .....	135
20.4.3 Setting Time Index .....	135
20.5 Arr Review .....	135
20.5.1 Scrolling the Screen .....	135
20.6 12-lead Diagnosis Review .....	136
20.6.1 Scrolling the Screen .....	136
20.6.2 Deleting Diagnosis Results .....	136
20.6.3 Switching Between Waveforms and Results .....	136
20.6.4 Recording .....	136
<b>Chapter 21 Calculation and Titration Table.....</b>	<b>137</b>
21.1 Drug Calculation .....	137
21.1.1 Calculation Procedures .....	137
21.1.2 Calculation Unit .....	138
21.2 Titration Table .....	138
21.3 Hemodynamic Calculation .....	139
21.3.1 Calculation Procedure .....	139
21.3.2 Input Parameters .....	139
21.3.3 Output Parameters .....	139
<b>Chapter 22 Recording.....</b>	<b>141</b>
22.1 General Information .....	141
22.2 Performance of the Recorder .....	141
22.3 Recording Type .....	142
22.4 Starting and Stopping Recording .....	142
22.5 Recorder Operations and Status Messages .....	143
22.5.1 Record Paper Requirement .....	143
22.5.2 Proper Operation .....	143
22.5.3 Paper Out .....	144
22.5.4 Replacing Paper .....	144
22.5.5 Removing Paper Jam .....	145
<b>Chapter 23 Other Functions.....</b>	<b>146</b>
23.1 Nurse Call .....	146
23.2 Analog Output and Defibrillator Synchronization .....	146
23.3 Storing Data in a Removable Device .....	146
23.3.1 Data Stored in the Removable Device .....	146
23.3.2 Activating/ Deactivating Data Storing .....	147
23.3.3 Selecting a Removable Device .....	147
23.3.4 Reviewing Data Stored in a Removable Device .....	147

23.3.5 Deleting Data Stored in a Removable Device.....	147
23.3.6 Ejecting a Removable Device .....	148
23.4 Wi-Fi Setup* .....	148
<b>Chapter 24 Using Battery .....</b>	<b>149</b>
24.1 Battery Power Indicator .....	149
24.2 Battery Status on the Main Screen .....	149
24.3 Checking Battery Performance .....	149
24.4 Replacing the Battery .....	150
24.5 Recycling the Battery .....	151
24.6 Maintaining the Battery.....	151
<b>Chapter 25 Care and Cleaning .....</b>	<b>152</b>
25.1 General Points .....	152
25.2 Cleaning .....	152
25.2.1 Cleaning the Monitor .....	153
25.2.2 Cleaning the Reusable Accessories.....	153
25.3 Disinfection .....	154
25.3.1 Disinfecting the Monitor .....	155
25.3.2 Disinfecting the Reusable Accessories.....	155
25.4 Cleaning and Disinfecting Other Accessories.....	156
<b>Chapter 26 Maintenance .....</b>	<b>157</b>
26.1 Inspecting .....	157
26.2 Maintenance Task and Test Schedule.....	157
<b>Chapter 27 Warranty and Service .....</b>	<b>159</b>
27.1 Warranty .....	159
27.2 Contact information .....	159
<b>Chapter 28 Accessories .....</b>	<b>160</b>
28.1 ECG Accessories.....	160
28.2 SpO <sub>2</sub> Accessories .....	162
28.3 NIBP Accessories .....	163
28.4 Temp Accessories.....	164
28.5 Quick Temp Accessories* .....	165
28.6 IBP Accessories.....	165
28.7 CO <sub>2</sub> Accessories.....	165
28.8 C.O. Accessories* .....	167
28.9 AG Accessories* .....	167
28.10 Other Accessories.....	168
<b>A Product Specification .....</b>	<b>169</b>
A.1 Classification.....	169
A.2 Physical Specifications.....	169
A.2.1 Size and Weight.....	169
A.2.2 Environment Specification.....	169
A.2.3 Display .....	170
A.2.4 Battery Specification .....	171
A.2.5 Recorder .....	171
A.2.6 Data Storage .....	172
A.3 Wi-Fi*.....	172

A.4 ECG.....	173
A.5 RESP.....	177
A.6 NIBP.....	178
A.7 SpO <sub>2</sub> .....	180
A.8 TEMP.....	181
A.9 Quick TEMP.....	181
A.10 IBP.....	181
A.11 CO <sub>2</sub> .....	182
A.12 C.O.....	185
A.13 AG.....	186
A.13.1 Phasein Sidestream.....	186
A.13.2 Phasein Mainstream.....	188
<b>B EMC Information.....</b>	<b>192</b>
B.1 Electromagnetic Emissions - for all EQUIPMENT and SYSTEMS.....	192
B.2 Electromagnetic Immunity - for all EQUIPMENT and SYSTEMS.....	192
B.3 Electromagnetic Immunity - for EQUIPMENT and SYSTEMS that are not LIFE-SUPPORTING.....	194
B.4 Recommended Separation Distances.....	195
<b>C Default Settings.....</b>	<b>197</b>
C.1 Patient Information Default Settings.....	197
C.2 Alarm Default Settings.....	197
C.3 ECG Default Settings.....	197
C.4 RESP.....	199
C.5 SpO <sub>2</sub> .....	199
C.6 PR.....	199
C.7 NIBP.....	200
C.8 TEMP.....	200
C.9 Quick TEMP.....	201
C.10 IBP.....	201
C.11 CO <sub>2</sub> .....	202
C.12 C.O.....	202
C.13 AG.....	203
<b>D Abbreviations.....</b>	<b>204</b>

# Chapter 1 Intended Use and Safety Guidance

## 1.1 Intended Use

The iM50 monitor monitors parameters such as ECG (3-lead, 5-lead selectable), Respiration (RESP), Functional arterial oxygen saturation (SpO<sub>2</sub>), Invasive or noninvasive blood pressure (dual-IBP, NIBP), Temperature (dual-TEMP), Expired CO<sub>2</sub> and Quick Temperature (Quick TEMP). The monitor is equipped with alarms that indicate system faults (such as loose or defective electrodes), physiologic parameters that have exceeded the limits set by the operator, or both.

The iM60 monitor monitors parameters such as ECG (3-lead, 5-lead selectable), Respiration (RESP), Functional arterial oxygen saturation (SpO<sub>2</sub>), Invasive or noninvasive blood pressure (2/4 channels IBP NIBP), Cardiac Output (CO), Temperature (dual-TEMP) and Expired CO<sub>2</sub>. The monitor is equipped with alarms that indicate system faults (such as loose or defective electrodes), physiologic parameters that have exceeded the limits set by the operator, or both.

The iM70 monitor monitors parameters such as ECG (3-lead, 5-lead selectable), Respiration (RESP), Functional arterial oxygen saturation (SpO<sub>2</sub>), Invasive or noninvasive blood pressure (2/4 channels IBP NIBP), Cardiac Output (CO), Temperature (dual-TEMP), Expired CO<sub>2</sub> and Anesthetic gas (AG). The monitor is equipped with alarms that indicate system faults (such as loose or defective electrodes), physiologic parameters that have exceeded the limits set by the operator, or both.

The iM80 monitor monitors parameters such as ECG (3-lead, 5-lead, 12-lead selectable), Respiration (RESP), Functional arterial oxygen saturation (SpO<sub>2</sub>), Invasive or noninvasive blood pressure (2/4 channels IBP NIBP), Cardiac Output (CO), Temperature (dual-TEMP), Expired CO<sub>2</sub> and Anesthetic gas (AG). The monitor is equipped with alarms that indicate system faults (such as loose or defective electrodes), physiologic parameters that have exceeded the limits set by the operator, or both.

The arrhythmia detection and ST Segment analysis are not intended for neonatal patients.

## 1.2 Safety Guidance

Federal (U.S.) law restricts this device to sale by or on the order of a physician.

---

**WARNING**

---

- 1 Before using the device, the equipment, patient cable and electrodes etc. should be checked. Replacement should be taken if there is any evident defect or signs of aging which may impair the safety or performance.
  - 2 Medical technical equipment such as these monitor/monitoring system must only be used by persons who have received adequate training in the use of such equipment and who are capable of applying it properly.
  - 3 EXPLOSION HAZARD-Do not use the device in a flammable atmosphere where concentrations of flammable anesthetics or other materials may occur.
  - 4 SHOCK HAZARD-To avoid the RISK of electric shock, this equipment must only be connected to a SUPPLY MAINS with protective earth.
  - 5 The equipment can provide protective means to prevent the patient from being burned when used with HF SURGICAL EQUIPMENT. The equipment can protect against the effects of the discharge of a defibrillator.
  - 6 Do not come into contact with the patient, table, or the monitor during defibrillation.
  - 7 The simultaneous use of cardiac pacemaker and other patient-connected equipment may cause safety hazard.
  - 8 Extreme care must be exercised when applying medical electrical equipment. Many parts of the human/machine circuit are conductive, such as the patient, connectors, electrodes, transducers. It is very important that these conductive parts do not come into contact with other grounded, conductive parts when connected to the isolated patient input of the device. Such contact would bridge the patient's isolation and cancel the protection provided by the isolated input. In particular, there must be no contact of the neutral electrode and ground.
  - 9 Magnetic and electrical fields are capable of interfering with the proper performance of the device. For this reason make sure that all external devices operated in the vicinity of the monitor comply with the relevant EMC requirements. X-ray equipment or MRI devices are a possible source of interference as they may emit higher levels of electromagnetic radiation.
  - 10 Route all cables away from patient's throat to avoid possible strangulation.
  - 11 Devices connecting with monitor should be equipotential.
-

---

---

**WARNING**

---

- 12 Accessory equipment connected to the analog and digital interfaces must be certified according to the respective IEC/EN standards (e.g. IEC/EN 60950 for data processing equipment and IEC/EN 60601-1 for medical equipment). Furthermore all configurations shall comply with the valid version of the standard IEC/EN 60601-1-1. Therefore anybody, who connects additional equipment to the signal input or output connector to configure a medical system, must make sure that it complies with the requirements of the valid version of the system standard IEC/EN60601-1-1. If in doubt, consult our technical service department or your local distributor.
  - 13 Only patient cable and other accessories supplied by EDAN can be used. Or else, the performance and electric shock protection cannot be guaranteed, and the patient may be injured.
  - 14 Do not rely exclusively on the auditory alarm system for patient monitoring. Adjustment of alarm volume to a low level or off during patient monitoring may result in a hazard to the patient. Remember that the most reliable method of patient monitoring combines close personal surveillance with correct operation of monitoring equipment.
  - 15 When interfacing with other equipment, a test for leakage current must be performed by qualified biomedical engineering personnel before using with patients.
  - 16 During monitoring, if the power supply is off and there is no battery for standby, the monitor will be off, and only the patient information and alarm settings can be saved. After reconnecting the power supply, the user should turn on the monitor for monitoring.
  - 17 Keep away from fire immediately when leakage or foul odor is detected.
  - 18 The device and accessories are to be disposed of according to local regulations after their useful lives. Alternatively, they can be returned to the dealer or the manufacturer for recycling or proper disposal. Batteries are hazardous waste. Do NOT dispose them together with house-hold garbage. At the end of their life hand the batteries over to the applicable collection points for the recycling of waste batteries. For more detailed information about recycling of this product or battery, please contact your local Civic Office, or the shop where you purchased the product.
  - 19 Dispose of the package material, observing the waste control regulations and keeping it out of children's reach.
  - 20 After defibrillation, the screen display recovers within 10 seconds if the correct electrodes are used and applied based on the manufacturers' instructions.
  - 21 This equipment is not intended for family usage.
  - 22 The monitors are not intended for use in an MRI environment.
  - 23 The monitors are MR Unsafe.
- 
-

---

---

**CAUTION**

---











---

- 1 Electromagnetic Interference - Ensure that the environment in which the patient monitor is installed is not subject to any sources of strong electromagnetic interference, such as radio transmitters, mobile telephones, etc.
  - 2 Keep the environment clean. Avoid vibration. Keep it far away from corrosive medicine, dust area, high temperature and humid environment.
  - 3 Do not immerse transducers in liquid. When using solutions, use sterile wipes to avoid pouring fluids directly on the transducer.
  - 4 Do not use autoclave or gas to sterilize the monitor, recorder or any accessories.
  - 5 The device and reusable accessories could be sent back to the manufacturer for recycling or proper disposal after their useful lives.
  - 6 Disposable devices are intended for single use only. They should not be reused as performance could degrade or contamination could occur.
  - 7 Remove a battery whose life cycle has expired from the monitor immediately.
  - 8 Avoid liquid splash on the device. The temperature must be kept between 5°C and 40°C while working. And it should be kept between -20°C and 55°C during transportation and storage.
  - 9 To ensure patient safety, use only parts and accessories manufactured or recommended by EDAN.
  - 10 The device must be connected to the ground to avoid the interference signal.
- 
- 











**NOTE:**









- 1 Position the device in a location where the operator can easily see the screen and access the operating controls.
- 2 The monitor can only be used on one patient at a time.
- 3 If the monitor gets damp or liquid pours on the monitor, please contact the service personnel of EDAN.
- 4 This monitor is not a device for treatment purposes.
- 5 The pictures and interfaces in this manual are for reference only.
- 6 Regular preventive maintenance should be carried out every two years. You are responsible for any requirements specific to your country.
- 7 The monitor may not be compatible with all models of USB flash drives. Use the USB flash drives that are recommended by EDAN.
- 8 It is recommended to format the USB flash drive to the FAT file type via PC prior to use.







### 1.3 Explanation of Symbols on the Monitor

	<p>This symbol indicates that the equipment is IEC/EN60601-1 Type CF equipment. The unit displaying this symbol contains an F-Type isolated (floating) patient applied part providing a high degree of protection against shock, and is suitable for use during defibrillation.</p>
	<p>This symbol indicates that the instrument is IEC/EN 60601-1 Type BF equipment. The unit displaying this symbol contains an F-Type isolated (floating) patient applied part providing a high degree of protection against shock, and is suitable for use during defibrillation.</p>
	<p>Symbol for “Caution”</p>
	<p>MR Unsafe</p>
	<p>Equipotential grounding terminal</p>
	<p>Alternating Current</p>
	<p>Power Supply switch</p>
	<p>Serial number</p>
	<p>Network port</p>
	<p>USB (Universal Serial Bus) Connection</p>



	Audio alarm is off
	NIBP measurement
	Trend graph
	Freeze
	Record
	Menu
	VGA output, External Monitor
	RS-232 port
	Nurse call port
	SD Card port
	Signal output port

	Signal output
	The symbol indicates that the device complies with the European Council Directive 93/42/EEC concerning medical devices.
	Authorized representative in the European community
	Date of manufacture
	Manufacturer
P/N	Part Number
	Recycle
	The symbol indicates that the device should be sent to the special agencies according to local regulations for separate collection after its useful life.
	Consult Instructions For Use
	Locked position

	Gas inlet
	Gas outlet (evac)
	ISA equipped to measure CO <sub>2</sub> only.
	ISA equipped to measure multiple gases.
Rx only (U.S.)	Federal (U.S.) Law restricts this device to sale by or on the order of a physician.
	(This mark is only applicable to iM50 and iM80 and is optional.) With respect to electrical shock, fire and mechanical hazards only in accordance with UL 60601-1 and CAN/CSA C22.2 No. 601.1, IEC 60601-2-25*, IEC 60601-2-27, IEC 60601-2-30, IEC 60601-2-34, IEC 60601-2-49, IEC 60601-2-51* (Symbol * means this standard only applicable to iM80)
	(This mark is only applicable to iM60 and iM70 and is optional.) Conforms to UL Std. 60601-1, IEC Std. 60601-2-27, IEC Std. 60601-2-30, IEC Std. 60601-2-34, IEC Std. 60601-2-49 Certified to CSA Std. C22.2 No 601.1, CSA Std. C22.2 No 60601-2-27, CSA Std. C22.2 No 60601-2-30, CSA Std. C22.2 No 60601-2-34, CSA Std. C22.2 No 60601-2-49

## Chapter 2 Installation

### NOTE:

- 1 The monitor settings must be specified by the authorized hospital personnel.
- 2 To ensure that the monitor works properly, please read the user manual and follow the steps before using the monitor.

### 2.1 Initial Inspection

Before unpacking, check the packaging and ensure that there are no signs of mishandling or damage. If the shipping cartons are damaged, contact the carrier for compensation and package them again.

Open the package carefully and remove the monitor and accessories. Check that the contents are complete and that the correct options and accessories have been delivered.

If you have any question, please contact your local supplier.

### 2.2 Mounting the Monitor

If all situations are normal, please place the monitor on a flat, level surface, hung on the bed rail, or mounted on a wall. About how to install the wall mount for the monitor, please refer to the following content.

#### 2.2.1 Installing Wall Mount for the Monitor

For how to install wall mount for the monitor, please refer to *Wall Mounting Bracket Assembly Instruction*.

### 2.3 Connecting the Power Cable

Connection procedure of the AC power line is listed below:

- 1 Make sure the AC power supply complies with the following specifications: 100V-240V~, 50Hz/60Hz.
- 2 Apply the power line provided with the monitor. Plug the power line to inlet interface of the monitor. Connect the other end of the power line to a grounded 3-phase power output.

### NOTE:

Connect the power line to the jack special for hospital usage.

### 2.4 Checking Out the Monitor

Make sure there is no damage on the measurement accessories and cables. Then turn on the monitor, check whether the monitor can start normally. Make sure all alarm lamps light up and the alarm sound is heard when turning on the monitor.

---

### WARNING

If any sign of damage is detected, or the monitor displays some error messages, do not use it on any patient. Contact Customer Service Center immediately.

---

**NOTE:**

- 1 Check all the functions of the monitor and make sure that the monitor is in good status.
- 2 If rechargeable batteries are provided, charge them after using the device every time, to ensure the electric power is enough.
- 3 The interval between double pressing of POWER switch should be longer than 1 minute.
- 4 After continuous 360-hour runtime, please restart the monitor to ensure the monitor's steady performance and long lifespan.

## 2.5 Checking the Recorder

If your monitor is equipped with a recorder, open the recorder's door to check if paper is properly installed in the slot. If no paper exists, refer to Chapter *Recording* for details.

## 2.6 Setting the Date and Time

To set the date and time:

1. Select **Menu > Maintenance > User Maintain > Date/Time Setup**.
2. Adjust the date display format based on the user's habit.
3. Set the correct time of year, month, day, hour, min and sec.

## 2.7 Handing Over the Monitor

If you are handing over the monitor to the end-users directly after configuration, make sure that it is in the monitoring mode.

The users must be adequately trained to use the monitor before monitoring a patient. To achieve this, they should have access to, and read, the following documentation delivered with the monitor:

- User Manual (this book) - for full operating instructions.
- Quick Reference Card - for quick reminders during use.

## 2.8 FCC Statement\*

\*The statement is not applicable to iM50 or iM80.

This equipment has been tested and found to comply with the limits for a Class B digital device, pursuant to part 15 of FCC Rules. These limits are designed to provide reasonable protection against harmful interference in a residential installation. This equipment generates and can radiate radio frequency energy and, if not installed and used in accordance with the instructions, may cause harmful interference to radio communications. However, there is no guarantee that interference will not occur in a particular installation. If this equipment does cause harmful interference to radio or television reception, which can be determined by turning the equipment off and on, the user is encouraged to try to correct the interference by one or more of the following measures:

1. Reorient or relocate the receiving antenna.
2. Increase the separation between the equipment and receiver.
3. Connect the equipment into an outlet on a circuit different from that to which the receiver is connected.
4. Consult the dealer or an experienced radio/TV technician for help.

This device complies with Part 15 of FCC Rules.

Operation is subject to the following two conditions:

1. This device may not cause harmful interference, and
2. This device must accept any interference received, including interference that may cause undesired operation.

**NOTE:**

The manufacturer is not responsible for any radio or TV interference caused by unauthorized modifications to this equipment. Such modifications could void the user's authority to operate this equipment.

## 2.9 FCC RF Radiation Exposure Statement\*

\*The statement is not applicable to iM50 or iM80.

This equipment complies with FCC RF radiation exposure limits set forth for an uncontrolled environment. This equipment should be installed and operated with a minimum distance of 20 centimeters between the radiator and your body.

## Chapter 3 Basic Operation

This manual is for clinical professionals using the iM50/iM60/iM70/iM80 patient monitors. Unless otherwise specified, the information here is valid for all the above products.

This user manual describes all features and options. Your monitor may not have all of them; they are not all available in all geographies. Your monitor is highly configurable. What you see on the screen, how the menus appear and so forth, depend on the way it has been tailored for your hospital and may not be exactly as shown here.

### 3.1 Overview

#### 3.1.1 Front View

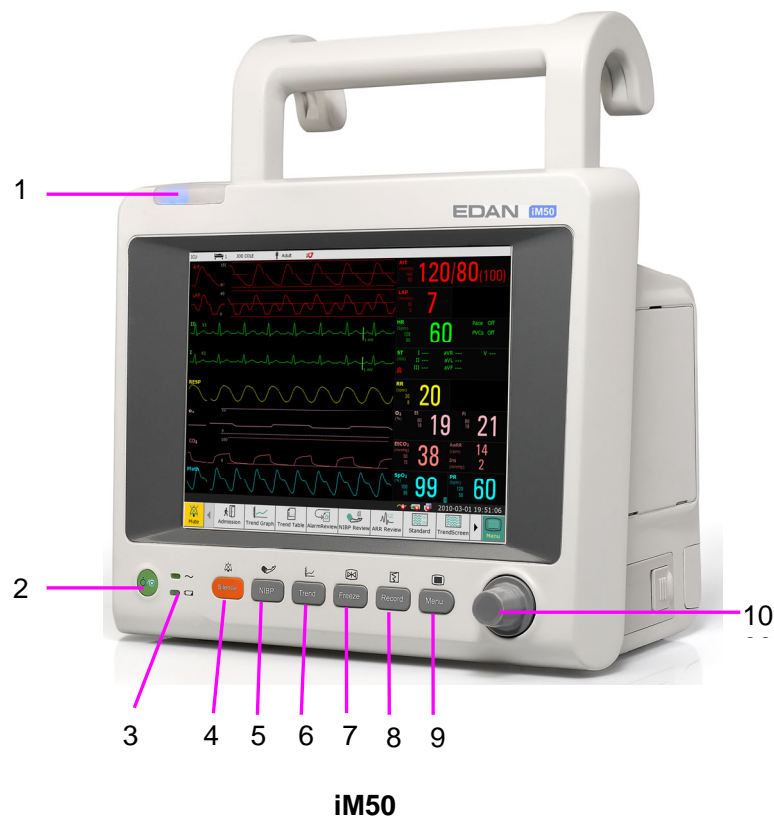

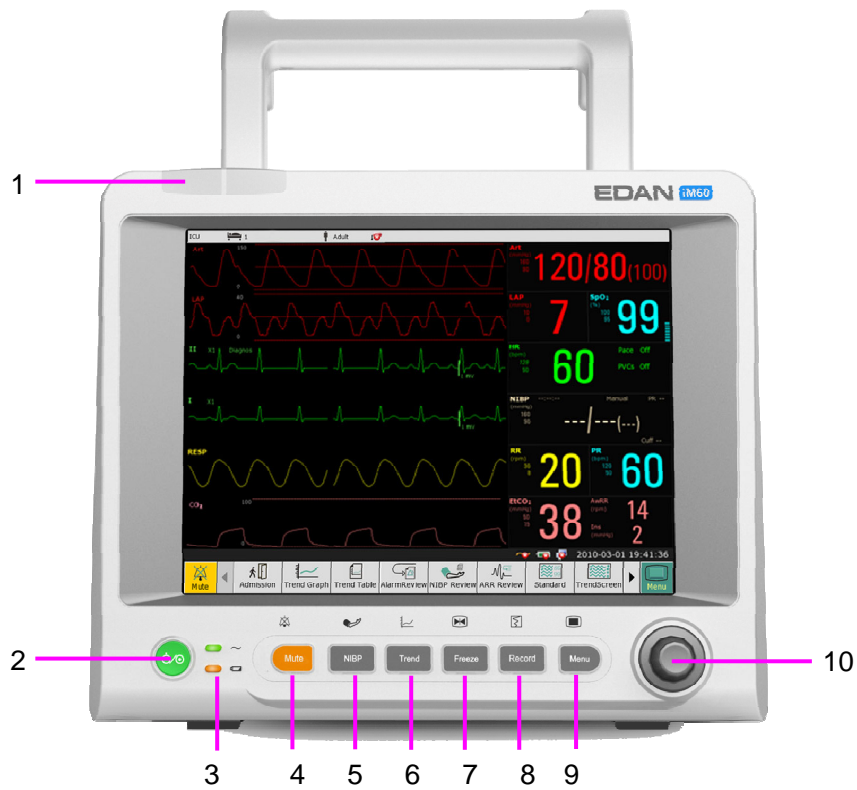

iM60

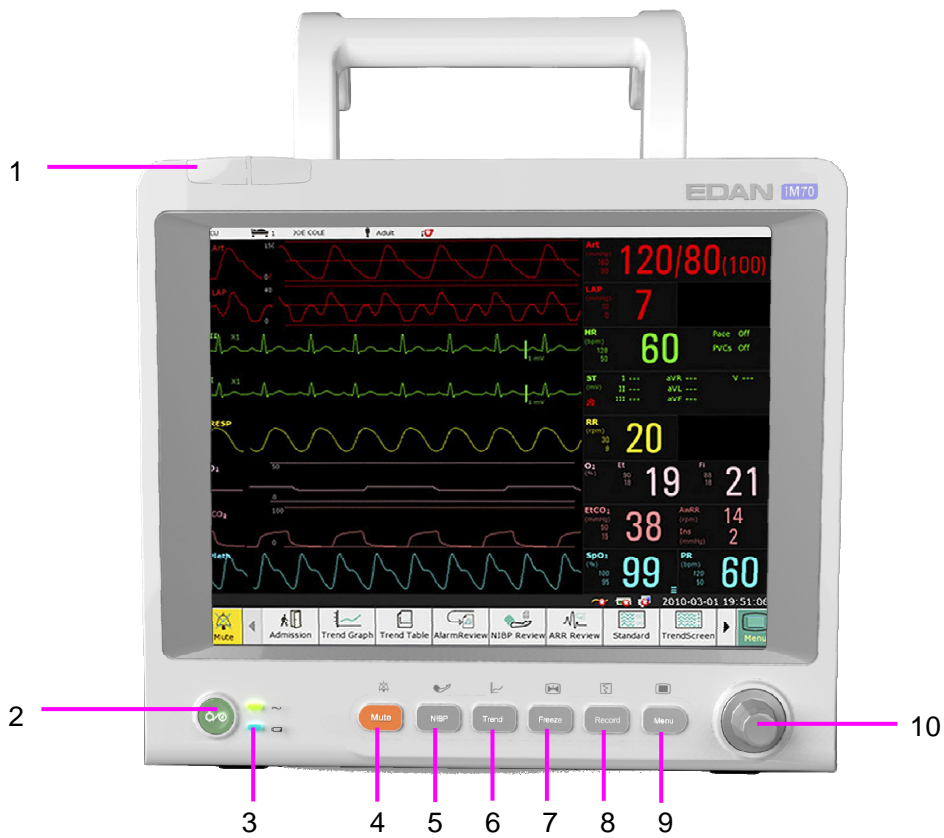



iM70

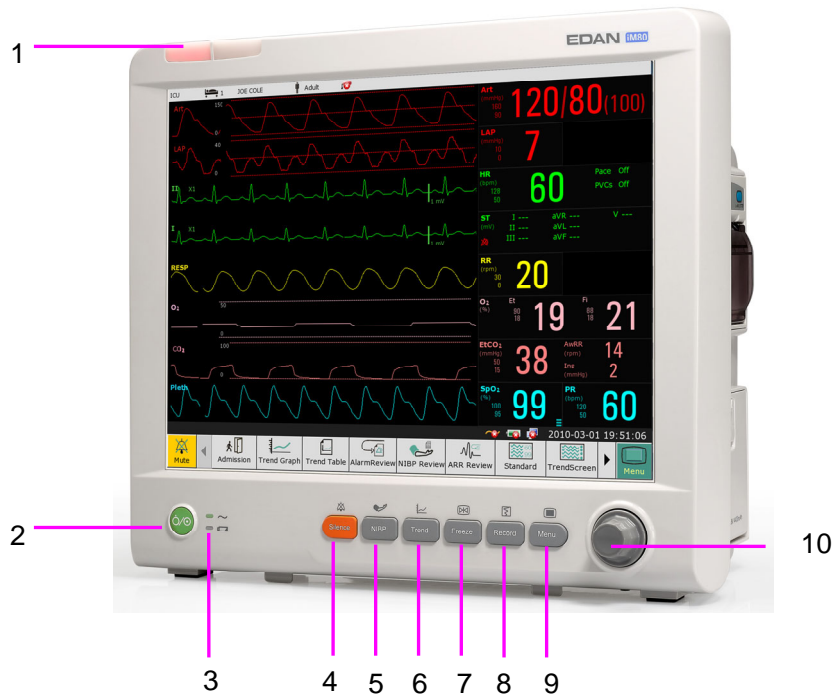



**iM80**

1	Alarm indicator — when an alarm occurs, the alarm indicator will light or flash. The color of light represents the alarm level.
2	Power supply switch — when the monitor is connected to the AC power supply, press the key to turn the monitor on. When the monitor is turned on, press the key to turn the monitor off.
3	Battery indicator, refer to Section <i>Battery Indicator</i> for details.
4	Mute — Press this button to pause the alarm. All the audio alarm will be closed. At the same time, the message of <b>Temporary Alarm Mute **s</b> and the symbol  will be displayed in the information area. When you repress it or the pause time is over, the system will resume the normal monitoring status and the message of <b>Temporary Alarm Mute **s</b> and icon will vanish. Symbol  is shown in the information area. Pressing or holding the button again can resume the alarm.  Further <b>Alarm Mute</b> information can be found in the chapter Alarm Mute.
5	Start / Stop NIBP measurement — Press this button to inflate the cuff and start blood pressure measurement. During the measurement, press the button to stop the measurement.
6	Trend Key — Press this button to enter trend table review interface.
7	Freeze /Unfreeze — In normal mode, press this button to freeze all the waveforms on the screen. In <b>Freeze</b> mode, press this button to restore the waveform refreshing.

8	Start / Stop Recording — Press this button to start a real-time recording. During the recording, press this button again to stop recording.
9	Menu — Press this button to return to the main interface when there is no menu open.
10	Rotary Knob (hereinafter called knob) — The user can rotate the knob clockwise or anticlockwise. This operation can make the highlighted item shift up, down, left or right to choose the desired item. Remember, when using the knob, rotate this button to highlight, and press it to select the item.

### 3.1.2 Rear View

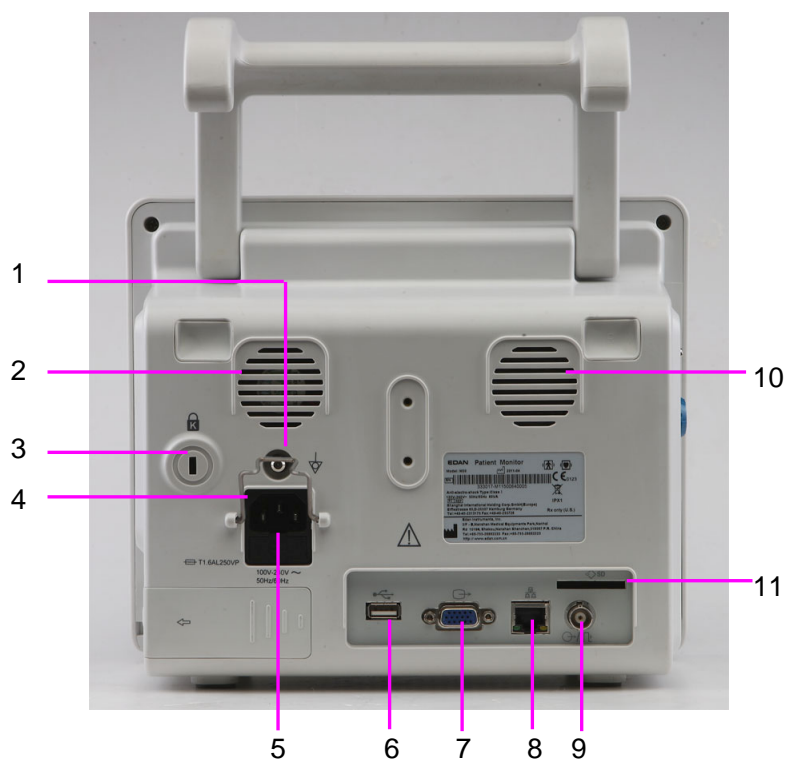

**iM50**

1	Equipotential grounding terminal, if the monitor or other processing unit are used in internal examinations on the heart, ensure that the room incorporates an equipotential grounding system to which the monitor and other processing unit have separate connection.
2	Fan
3	Anti-theft lock interface
4	Security lock, used to prevent the power supply cord from falling.
5	Power Supply Inlet
6	USB interface, this port is used to connect the USB device.

7	VGA Interface
8	Network interface, this port is used to connect to the central monitoring system through the standard network wire.
9	Defibrillator synchronization / analog output. When the user selects <b>Analog Output</b> , the monitor outputs the waveform through the auxiliary output port. When the user selects <b>Defibrillation</b> the monitor outputs the defibrillator synchronization signal through the auxiliary output port.
10	Speaker
11	SD Card

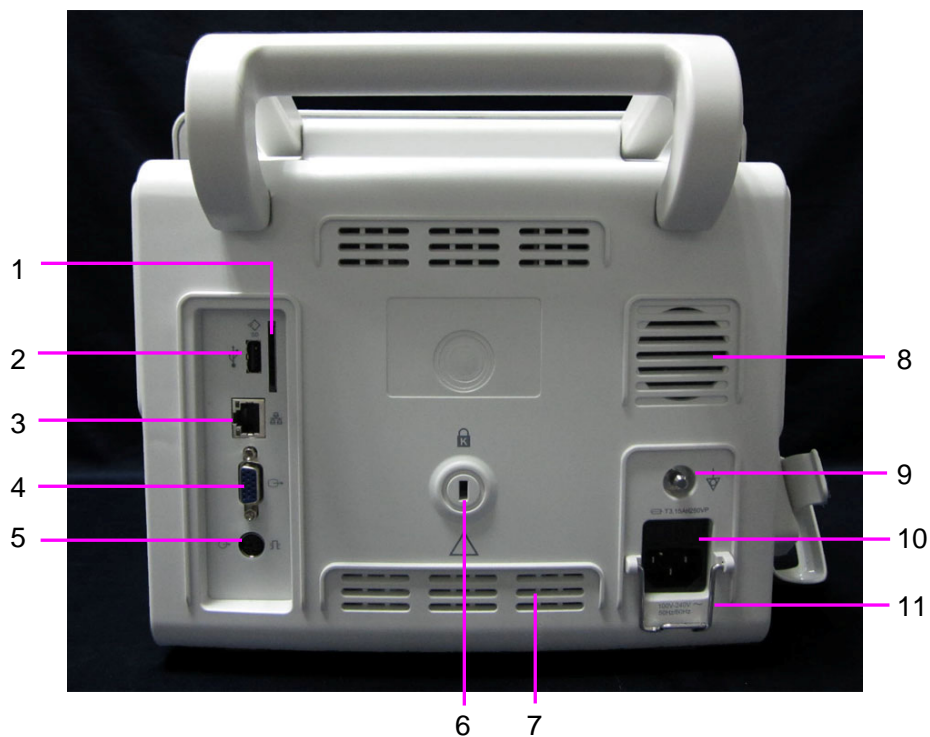

**iM60/iM70**

1	SD Card
2	USB interface, this port is used to connect the USB device.
3	Network interface, this port is used to connect to the central monitoring system through the standard network wire.
4	VGA output

5	Defibrillator synchronization/ analog output/ nurse call port: When the user selects <b>Analog Output</b> , the monitor outputs the waveform through the auxiliary output port. When the user selects <b>Defibrillation</b> , the monitor outputs the defibrillator synchronization signal through the auxiliary output port. When the port is used as nurse call port, it is connected to the call system. When there is an alarm, the monitor outputs nurse call signal to notify the nurse.
6	Anti-theft lock interface
7	Heat sink
8	Speaker
9	Equipotential grounding terminal, if the monitor or other processing unit are used in internal examinations on the heart, ensure that the room incorporates an equipotential grounding system to which the monitor and other processing unit have separate connection.
10	Power Supply Inlet
11	Security lock, used to prevent the power supply cord from falling.

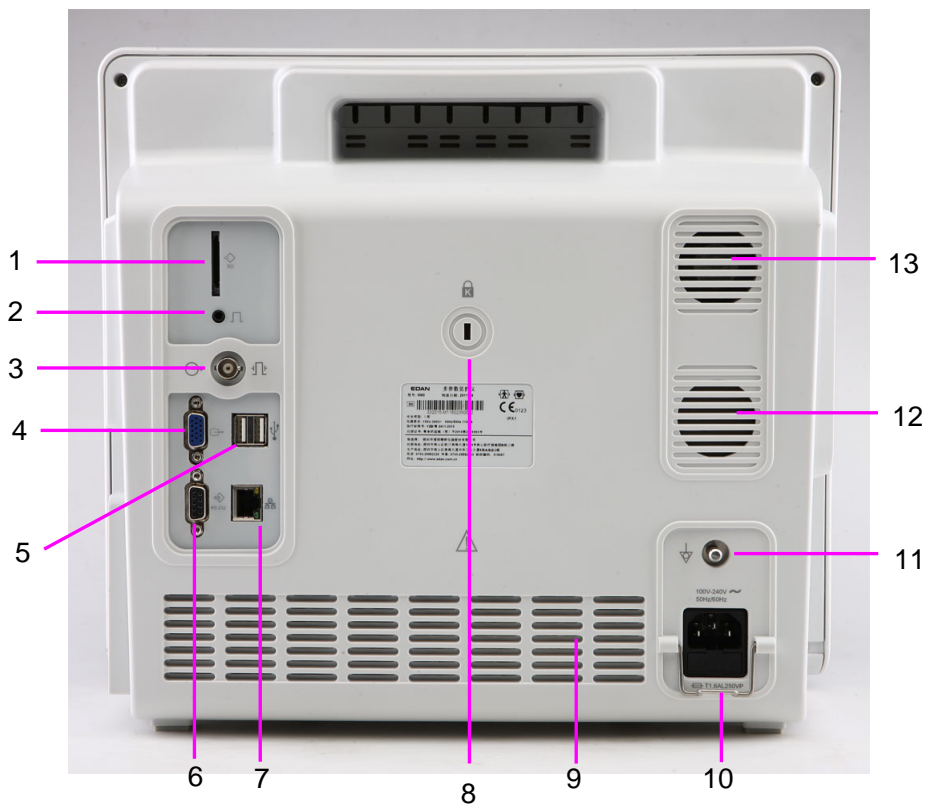

iM80

1	SD Card
2	Nurse call port, this port is connected to the call system. When there is an alarm, the monitor outputs nurse call signal to notify the nurse.
3	Defibrillator synchronization / analog output. When the user selects <b>Analog Output</b> , the monitor outputs the waveform through the auxiliary output port. When the user selects <b>Defibrillation</b> , the monitor outputs the defibrillator synchronization signal through the auxiliary output port.
4	VGA output
5	USB interface, this port is used to connect the USB device.
6	RS232 interface
7	Network interface, this port is used to connect to the central monitoring system through the standard network wire.
8	Anti-theft lock interface
9	Heat emission hole
10	Security lock, used to prevent the power supply cord from falling.
11	Equipotential grounding terminal, if the monitor or other processing unit are used in internal examinations on the heart, ensure that the room incorporates an equipotential grounding system to which the monitor and other processing unit have separate connection.
12	Speaker
13	Fan

### 3.1.3 Side View



**iM50**

1	Sensor interface
2	CO <sub>2</sub> module holder
3	Recorder door
4	Battery door



**iM60/iM70**

1	Sensor port
2	CO <sub>2</sub> module holder
3	Recorder door
4	Battery door



**iM80**

1	Sensor port
2	AG module holder
3	Recorder door
4	Battery door

### 3.1.4 Configuration

Model	Size (L×W×H)	Function Configuration
iM50	261 mm (L) × 198 mm (W) × 215 mm (H)	ECG, RESP, SpO <sub>2</sub> , NIBP, IBP, TEMP, Quick TEMP, CO <sub>2</sub>
iM60	303mm(L) × 161mm(W) × 254mm(H)	ECG, RESP, SpO <sub>2</sub> , NIBP, TEMP, IBP, C.O., CO <sub>2</sub>
iM70	328mm(L) × 158mm(W) × 285mm(H)	ECG, RESP, SpO <sub>2</sub> , NIBP, TEMP, IBP, C.O., CO <sub>2</sub> , AG
iM80	370 mm (L) × 175 mm (W) × 320 mm (H)	ECG, RESP, SpO <sub>2</sub> , NIBP, TEMP, IBP, C.O., CO <sub>2</sub> , AG

## 3.2 Operating and Navigating

Everything you need to operate the monitor is contained on its screen. Almost every element on the screen is interactive. Screen elements include measurement data, waveforms, screen keys, information fields, alarms fields and menus. The configurability of the monitor means that often you can access the same element in different ways. For example, you might be able to access an item through its on-screen setup menu, via a hard key, or via a shortcut key. The User Manual always describes how to access items via an on-screen menu. You may use whichever way you find most convenient.



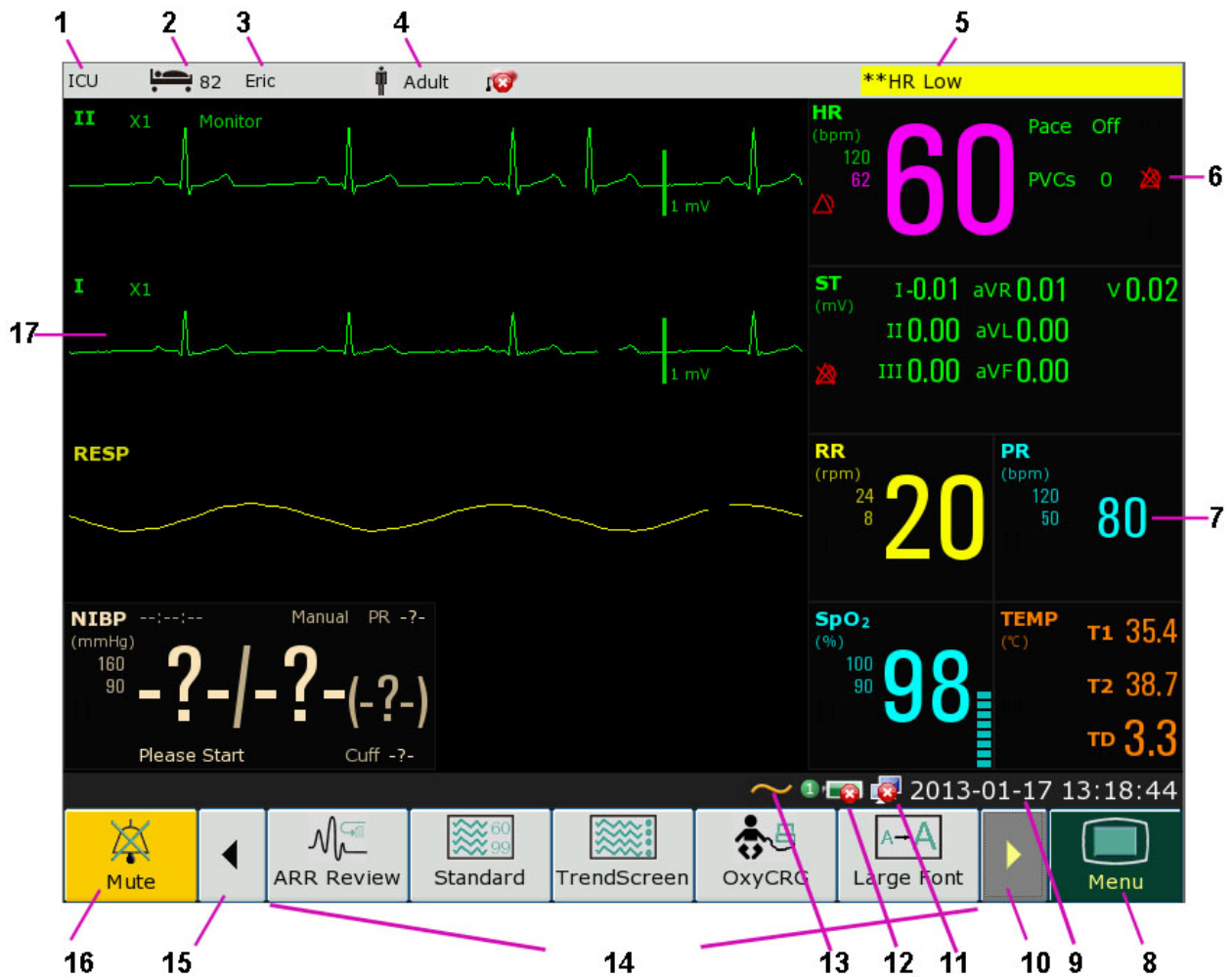

1	Department
2	Bed number
3	Patient name
4	Patient type
5	Alarm area
6	Alarm off
7	Measurement value
8	Menu
9	Date and time
10	Scroll right to display more shortcut keys
11	Networking symbol
12	Battery status symbol
13	AC power supply symbol

14	Shortcut key area
15	Scroll left to display more shortcut keys
16	Mute key
17	Parameter waveform

### 3.2.1 Using Keys

The monitor has four different types of keys:

#### 3.2.1.1 Permanent Keys

A permanent key is a graphical key that remains on the screen all the time to give you fast access to functions.



Menu – enter the main setup menu.



Mute key – close the audio alarm to switch off the alarm.

#### 3.2.1.2 Shortcut Keys

A shortcut key is a configurable graphical key, located at the bottom of the main screen. It gives you fast access to functions. The selection of shortcut keys available on your monitor depends on your monitor configuration and on the options purchased.



Perform a 12-lead analysis



Switch to the standard screen



Exit from 12-lead analysis



Switch to the OxyCRG screen



Access the 12-lead review



Switch to the large font screen



Perform 12-lead record



Set the module switch



Admit a patient





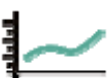







Change the key volume



Review the trend graph



Adjust the screen brightness

	Review the trend table		Zero the IBP sensor
	Review the alarm event		Alarm setup
	Access the NIBP review		Change the beat volume
	Access the ARR review		Enter standby mode
	Switch to the trend screen		Enter night mode
	Select this item by the trim knob to enable the touch screen operation		

### 3.2.1.3 Hardkeys

A hardkey is a physical key on a monitoring device, such as the recording key on the front panel.

### 3.2.1.4 Pop-up keys

Pop-up keys are task-related graphical keys that appear automatically on the screen when required. For example, the confirmation pop-up key appears only when you need to confirm a change.

## 3.3 Operating Mode

### 3.3.1 Demo Mode

To change the operating mode into the demo mode, please refer to the following procedure:

Select **Menu** > **Common Function**, then choose **Demo Mode** from the popup interface and input password **3045**.

After entering **Demo Mode**, the monitor will perform the followings:

- Storing no data of new patient.
- Pausing to give all types of alarm.
- Pausing to transmit patient data to CMS and other network devices.
- Pausing to store the currently recorded data, and clearing the memory used to store recording and printing data.

- Real data: the parameter measurement value and real waveform displayed on the screen are from the predefined analog data, not the truly monitoring patients' data.
- History data: the monitor will store the analog real-time data in Demo mode, including trend data, patient information, alarm event, waveform and setting.

To exit **Demo Mode**, select **Menu > Common Function > Demo Mode** to exit.

---

### WARNING

---

This is for demonstration purposes only. You must not change into Demo Mode during monitoring. In Demo Mode, all stored trend information is deleted from the monitor's memory.

---

## 3.3.2 Standby Mode

Standby mode can be used when you want to temporarily interrupt monitoring. To enter standby mode, please press the shortcut key  on the screen directly. To resume monitoring, select anything on the screen or press any key.

## 3.3.3 Night Mode

To switch to night mode, you may:

- Select the shortcut key  on the main screen, or
- Select **Menu> Common Function> Night Mode**.

### NOTE:

In night mode, the sound of key, heart beat and pulse is muted; the alarm volume and screen brightness are down to their minimum; the settings including key volume, beat volume, PR volume, alarm volume and screen brightness are unavailable.

## 3.4 Changing Monitor Settings

### 3.4.1 Adjusting Screen Brightness

To change the screen brightness, please:

1. Press the **Brightness** key on the screen directly or.
2. Select **Menu > Common Function > Brightness**, and select the appropriate setting for the screen brightness. **10** is the brightest, **1** is the least bright.

Your monitor may be configured with lower brightness in standby mode and also for transport to conserve battery power.

## 3.4.2 Changing Date and Time

To change the date and time, please refer to Section *Setting Date and Time*.

---

**WARNING**

---

Change to date and time will influence the storage of trend data.

---

## 3.5 Adjusting Volume

### 3.5.1 Adjusting Key Volume

The key volume is the volume you hear when you select any field on the monitor screen or when you turn the knob. To adjust the key volume, please:

1. Select the **Key Volume** key on the screen directly or.
2. Select **Menu > System Setup > Key Volume**, then select the appropriate setting for the key volume: **Five** is the loudest and **Zero** is the quietest.

### 3.5.2 Adjusting Alarm Volume

To change the alarm volume, please

1. Press the **Alarm Volume** key on the screen directly or.
2. Select **Menu > Alarm Setup > Alarm Volume**, and select the desired setting from the popup interface. For detailed information, please refer to Section *Controlling Alarm Volume*.

### 3.5.3 Adjusting Beat Volume

To change the beat volume, please press the **Beat Volume** key on the screen directly or refer to Section *Setting Beat Volume*.

## 3.6 Checking Your Monitor Version

To check the monitor version, please select **Menu > Common Function > About** to check the monitor software revision.

## 3.7 Networked Monitoring

Your monitor can be connected to the wired network. If the monitor is networked, a network symbol is displayed on the screen.

## 3.8 Setting Languages

To change the language, please:



1. Select **Menu > Maintenance > User Maintain**, then type the correct password **ABC** into the displayed interface.
2. Select the **Language** option on the popup interface to open the language list.
3. Select the desired language from the list. To make the change validate, please restart the monitor.

## 3.9 Understanding Screens



Your monitor comes with a set of preconfigured screens, optimized for common monitoring scenarios such as OR adult, or ICU neonatal. A screen defines the overall selection, size and position of waves, numeric and shortcut keys on the monitor screen when you switch on the monitor. You can easily switch between different screens during monitoring. Screens do NOT affect alarm settings, patient category and so forth. When you switch from a complex to a less complex screen layout, some measurements may not be visible but are still monitored in the background. For detailed information, please refer to *Chapter User Interface*.

## 3.10 Calibrating Screens

To calibrate the screen, please refer to the following steps:

1. Select **Menu > Maintenance > User Maintain**, then input maintenance password **ABC**, then select **TouchScr Calibration** from the popup interface.
2. The symbol  appears on the screen.
3. Click on the central point of the symbol .
4. After successful calibration, the message of **Screen Calibration Completed** appears on the screen. Then select **Exit** to finish the calibration.

## 3.11 Disabling the Touch Screen

The user can disable touch screen operation by pressing and holding the **Menu** shortcut key for 3 seconds. A message of **Screen Locked** and the symbol  are displayed at the bottom of screen if the touch screen is disabled. To enable the touch screen operation, turn the knob to select the symbol  and press it.

## 3.12 Using the Barcode Scanner

To enter the barcode setup menu, please select **Menu > Maintenance > User Maintain**, after entering the required password **ABC**, select **Other Setup > BarCode Setup**. Then the user can set serial No, last Name, first Name and so on.

If **Auto Update** is set to **On**, the patient information is updated automatically by using a bar code scanner. If **Auto Update** is set to **Off**, the user needs to update the patient information manually.

## 3.13 Resolving IBP Label Conflicts

Each label must be unique and can only be assigned once. The measurement labels are stored in the measurement modules. If you try to use two IBP channels that have identical labels, this causes a label conflict in the monitor.

For example, an IBP channel (channel A) has already been loaded and the label Art is used for channel A. Then another IBP channel (channel B) is loaded and the label Art is also used for channel B. In this case, a label conflict will be triggered. A prompt indicating IBP label conflict will appear on the left of the screen. Additionally, at the corresponding measurements area, a label flickers to indicate a label conflict. The flickering label is the default one assigned by the system.

The IBP channel with a label conflict will not provide any measurement data; besides, the functions of setup, zeroing and calibrating are unavailable. To resolve the label conflict, you have to change the conflicting label into a non-conflicting one via the following method:

- 1 Select the IBP channel with a label conflict on the screen and open the **Options** menu.
- 2 Choose another label among the options from the **Alias** pull-down list to resolve the label conflict.

## Chapter 4 Alarms

The alarm information here applies to all measurements. Measurement-specific alarm information is discussed in the sections of individual measurements.

---

### WARNING

---

A potential hazard can exist if different alarm presets are used for the same or similar equipment in any single area, e.g. an intensive care unit or cardiac operating room.

---

### 4.1 Alarm Category

The monitor provides two types of alarms: physiological alarms and technical alarms.

#### 4.1.1 Physiological alarms

If one or several physiological parameters of the currently monitored patient exceed the predefined alarm limit, for example: SpO<sub>2</sub> values exceed the alarm limit, the monitor will give an alarm, and this type of alarm is called physiological alarms. About the detailed alarm information, please refer to the Section *physiological alarm information*.

#### 4.1.2 Technical Alarms

If one or several technical status of the device is in abnormal status, such as: lead off or low battery and so on, the monitor will give an alarm. And this type of alarm is called technical alarms. About the detailed alarm information, please refer to Section *technical alarm information*.

#### 4.1.3 Prompts

The monitor can give the character indication of monitoring process or other functions, such as: ARR Relearning and so on. And this character is called prompts. About the detailed alarm information, please refer to Section *Prompts*.

### 4.2 Alarm Levels

In terms of severity, the device's alarm levels can be classified into three categories: high level alarms, medium level alarms and low level alarms.

#### 1. High level alarms

A high level alarm intensively warns the operator of a high priority alarm condition which requires immediate operator response. Failure to respond to the cause of the alarm condition is likely to result in death or irreversible injury of the patient.

#### 2. Medium level alarms

A medium level alarm warns the operator of a medium priority alarm condition which requires prompt operator response. Failure to respond to the cause of the alarm condition is likely to result in reversible injury of the patient.



### 3. Low level alarms

A low level alarm reminds the operator of a low priority alarm condition which requires response. And the response time for a low priority alarm condition can be greater than that for a medium priority alarm condition. Failure to respond to the cause of the alarm condition is likely to result in discomfort or reversible minor injury of the patient.

The high/medium/low-level alarms are indicated by the system in following different ways:

Alarm level	Prompt	Physiological alarms	Technical alarms
High	Mode is “DO-DO-DO-----DO-DO, DO-DO-DO-----DO-DO”, which is triggered once every 10 seconds.	The alarm indicator flashes in red, with a frequency of 1.4Hz ~ 2.8Hz. The alarm message flashes with red background, and the symbol *** is displayed at the alarm area.	The alarm indicator flashes in red. The alarm message flashes with red background, and the symbol *** is displayed at the alarm area.
Medium	Mode is “DO-DO-DO”, which is triggered once every 25 seconds.	The alarm indicator flashes in yellow, with a frequency of 0.4Hz ~ 0.8Hz. The alarm message flashes with yellow background, and the symbol ** is displayed at the alarm area.	No definition
Low	Mode is “DO-”, which is triggered once every 30 seconds.	The alarm indicator flashes in yellow. The alarm message flashes with yellow background, and the symbol * is displayed at the alarm area.	The alarm indicator flashes in blue. The alarm message flashes with yellow background, and the symbol * is displayed at the alarm area.

The sound pressure range for auditory alarm signals is from 45 dB to 85 dB.

## 4.3 Controlling Alarm

### 4.3.1 Setting Parameter Alarm

Parameter alarm settings including alarm switch, alarm record, alarm level and alarm limit are available on the respective alarm setup menu for each parameter. To access the menu for parameter alarm settings, use the shortcut key  or select **Menu> Alarm Setup**, and then

click **Alarm Options** to open the menu shown below for alarm settings of each parameter. Also, you can access this menu via the respective parameter setup menu.

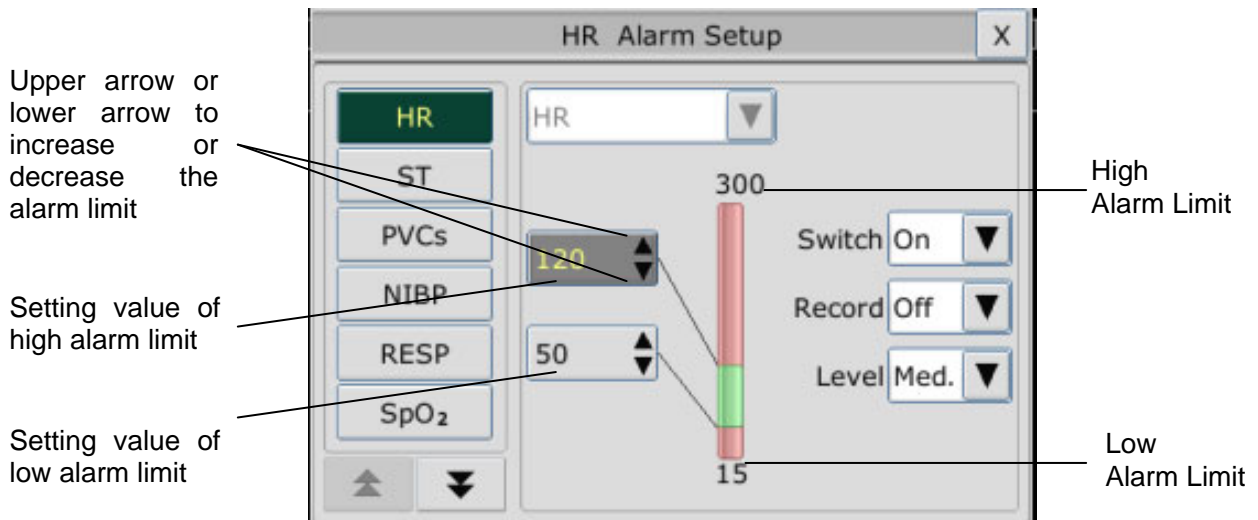

### WARNING

- 1 When the alarm is set to OFF, the monitor won't give an alarm prompt even if an alarm occurs. In order to avoid endangering the patient's life, the user should use this function cautiously.
- 2 Prior to monitoring, make sure that the alarm limit settings are appropriate for your patient.
- 3 Setting alarm limits to extreme values may cause the alarm system to become ineffective.

### 4.3.2 Temporary Alarm Mute

You can pause an auditory alarm for an activated alarm condition by pressing the key  on the front panel.

While the auditory alarm is paused, the alarm is not sounding. But the alarm indicator on the front panel and the graphical alarm indicator on the screen are still flashing. Additionally, in the alarm area:

1. The monitor displays the auditory alarm pause symbol .
2. The monitor displays the remaining pause time in seconds with a red background.

The user can set the duration of auditory alarm pause to **60 s**, **120 s**, or **180 s**.

#### NOTE:

If a new alarm occurs during alarm pause, the auditory alarm pause will terminate and the new alarm will be sounding.

### 4.3.3 Alarm Mute

To mute the alarm, please select **Menu > Maintenance > User Maintain > Alarm Setup**, and

set **Mute** to **On**, then press the key  on the front panel and hold it for more than three seconds or press the **Mute** shortcut key on the screen directly.

While the auditory alarm is muted, the alarm is not sounding. But the alarm indicator on the front panel and the graphical alarm indicator on the screen are still flashing. And the alarm reminder tone DO is heard every three minutes. Additionally, in the alarm area:

1. The monitor displays the alarm mute symbol .
2. The monitor displays **Alarm Mute** with a red background.

#### **NOTE:**

If a new alarm occurs during the alarm mute period, the alarm mute period will terminate and the new alarm will be sounding.

### 4.3.4 Controlling Alarm Volume

The monitor provides five levels of alarm volume: **1, 2, 3, 4** and **5**. For adjusting the alarm volume, please refer to Section *Adjusting Alarm Volume*.

## 4.4 Latching Alarms

To set the alarm latch function, please select **Menu > Maintenance > User Maintain > Alarm Setup** and set **Alarm Latch** from the pull-down list. If it is set to **On**, when an alarm occurs, the monitor will display the alarm message of the parameter in the alarm status area. If the parameter resumes to normal, the alarm information of this parameter still displays in the alarm display area and the alarm time is also displayed. If many parameters appear to be latching alarms, the alarm messages are displayed in the physiological alarm message area in turn.

To deselect the alarm latch, please set **Alarm Latch** to **Off**. When **Alarm Latch** is set to **Off**, the latch function is invalid.

## 4.5 Disabling Sensor Off Alarms

To set sensor off alarm, please select **Menu > Maintenance > User Maintain** and enter the required password **ABC**. Then select **Alarm Setup** and set **Sensor Off Alm** from the pull-down list. If it is set to **On**, and a sensor off alarm occurs, the user can press the Mute key on the front panel to disable the alarm signal. Then the alarm indicator stops flashing, and the monitor is in temporary mute alarm status. If the user presses the Mute key again or the temporary mute time ends, no auditory alarm for sensor-off status will be resumed. Instead, sensor-off status will be announced with a prompt message.

## 4.6 Testing Alarms

When you switch the monitor on, a self test is started. You must check that the alarm indicator lights and that you hear a single tone. This indicates that the visible and auditory alarm indicators are functioning correctly. For further testing of individual measurement alarms, perform the measurement on yourself or use a simulator. Adjust alarm limits and check that appropriate alarm behavior is observed.

## Chapter 5 Alarm Information

### 5.1 Physiological Alarm Information

Message	Cause	Alarm level
HR High	HR measuring value is above the upper alarm limit.	User-selectable
HR Low	HR measuring value is below the lower alarm limit.	User-selectable
ST-X High	ST measuring value is above the upper alarm limit. (X stands for I, II, III, aVR, aVL, aVF, V, V1, V2, V3, V4, V5 or V6)	User-selectable
ST-X Low	ST measuring value is below the lower alarm limit.(X stands for I, II, III, aVR, aVL, aVF, V, V1, V2, V3, V4, V5 or V6)	User-selectable
PVCs High	PVCs measuring value is above the upper alarm limit.	User-selectable
ASYSTOLE	No QRS is detected for 4 consecutive seconds	High
VFIB/VTAC	Ventricular tachycardia: The RR interval of 4-second fibrillation wave or 5 consecutive ventricular beats is less than 600 ms.	High
VT>2	3< the number of cluster PVCs < 5	User-selectable
COUPLET	2 consecutive PVCs	User-selectable
BIGEMINY	Vent Bigeminy	User-selectable
TRIGEMINY	Vent Trigeminy	User-selectable
R ON T	A type of single PVC under the condition that HR<100, R-R interval is less than 1/3 the average interval, followed by a compensating pause of 1.25X the average R-R interval (the next R wave advances onto the previous T wave).	User-selectable
PVC	Single PVC detected in normal heartbeats.	User-selectable
TACHY	Adult: 5 consecutive QRS complex, RR interval < 0.5s (HR range: 120~300bpm). Pediatric/neonatal: 5 consecutive QRS complex, RR interval < 0.375s (HR range: 160~350bpm).	User-selectable
BRADY	Adult: 5 consecutive QRS complex, RR interval ≥ 1.5s (HR range: 15~40bpm). Pediatric/neonatal: 5 consecutive QRS complex, RR interval ≥ 1s (HR range: 15~60bpm).	User-selectable

Message	Cause	Alarm level
MISSED BEATS	When HR is less than 120 beats/min., no heart beat is tested during the period 1.75 times of the average RR interval; or When HR is $\geq$ 120 beats/min, no beat is tested within 1 second.	User-selectable
IRR	IRREGULAR RHYTHM: The patient has irregular heart rate.	User-selectable
PNC	PACE NOT CAPTURE: After the pacemaker is paced, QRS complex can not be detected during 300ms.	User-selectable
PNP	PACER NOT PACED: After the QRS complex, no pace is detected during 1.75 times of RR interval.	User-selectable
VBRADY	VENTRICULAR BRADYCARDIA: The interval of 5 consecutive ventricular wave is more than 1000 ms.	User-selectable
VENT	VENTRICULAR RHYTHM: The interval of 5 consecutive ventricular wave ranges from 600 ms to 1000 ms.	User-selectable
RESP APNEA	RESP can not be measured within the set apnea alarm delay time.	High
RR High	RR measuring value is above upper alarm limit.	User-selectable
RR Low	RR measuring value is below lower alarm limit.	User-selectable
SpO <sub>2</sub> High	SpO <sub>2</sub> measuring value is above upper alarm limit.	User-selectable
SpO <sub>2</sub> Low	SpO <sub>2</sub> measuring value is below lower alarm limit.	User-selectable
SpO <sub>2</sub> No Pulse	The signal of the measurement site is too weak, so the monitor can't detect the pulse signal.	High
PR High	PR measuring value is above upper alarm limit.	User-selectable
PR Low	PR measuring value is below lower alarm limit.	User-selectable
T1 High	Measuring value of T1 channel is above upper alarm limit.	User-selectable
T1 Low	Measuring value of T1 channel is below lower alarm limit.	User-selectable
T2 High	Measuring value of T2 channel is above upper alarm limit.	User-selectable
T2 Low	Measuring value of T2 channel is below lower alarm limit.	User-selectable
TD High	Measuring value of TD channel is above upper alarm limit.	User-selectable

<b>Message</b>	<b>Cause</b>	<b>Alarm level</b>
SYS High	SYS measuring value is above upper alarm limit.	User-selectable
SYS Low	SYS measuring value is below lower alarm limit.	User-selectable
DIA High	DIA measuring value is above upper alarm limit.	User-selectable
DIA Low	DIA measuring value is below lower alarm limit.	User-selectable
MAP High	MAP measuring value is above upper alarm limit.	User-selectable
MAP Low	MAP measuring value is below lower alarm limit.	User-selectable
Art SYS High	Art SYS measuring value is above upper alarm limit.	User-selectable
Art SYS Low	Art SYS measuring value is below lower alarm limit.	User-selectable
Art DIA High	Art DIA measuring value is above upper alarm limit.	User-selectable
Art DIA Low	Art DIA measuring value is below lower alarm limit.	User-selectable
Art MAP High	Art MAP measuring value is above upper alarm limit.	User-selectable
Art MAP Low	Art MAP measuring value is below lower alarm limit.	User-selectable
PA SYS High	PA SYS measuring value is above upper alarm limit.	User-selectable
PA SYS Low	PA SYS measuring value is below lower alarm limit.	User-selectable
PA DIA High	PA DIA measuring value is above upper alarm limit.	User-selectable
PA DIA Low	PA DIA measuring value is below lower alarm limit.	User-selectable
PA MAP High	PA MAP measuring value is above upper alarm limit.	User-selectable
PA MAP Low	PA MAP measuring value is below lower alarm limit.	User-selectable
CVP MAP High	CVP MAP measuring value is above upper alarm limit.	User-selectable
CVP MAP Low	CVP MAP measuring value is below lower alarm limit.	User-selectable
ICP MAP High	ICP MAP measuring value is above upper alarm limit.	User-selectable
ICP MAP Low	ICP MAP measuring value is below lower alarm limit.	User-selectable
LAP MAP High	LAP MAP measuring value is above upper alarm limit.	User-selectable
LAP MAP Low	LAP MAP measuring value is below lower alarm limit.	User-selectable
RAP MAP High	RAP MAP measuring value is above upper alarm limit.	User-selectable
RAP MAP Low	RAP MAP measuring value is below lower alarm limit.	User-selectable
P1 SYS High	P1 SYS measuring value is above upper alarm limit.	User-selectable
P1 SYS Low	P1 SYS measuring value is below lower alarm limit.	User-selectable
P1 DIA High	P1 DIA measuring value is above upper alarm limit.	User-selectable
P1 DIA Low	P1 DIA measuring value is below lower alarm limit.	User-selectable
P1 MAP High	P1 MAP measuring value is above upper alarm limit.	User-selectable
P1 MAP Low	P1 MAP measuring value is below lower alarm limit.	User-selectable

Message	Cause	Alarm level
P2 SYS High	P2 SYS measuring value is above upper alarm limit.	User-selectable
P2 SYS Low	P2 SYS measuring value is below lower alarm limit.	User-selectable
P2 DIA High	P2 DIA measuring value is above upper alarm limit.	User-selectable
P2 DIA Low	P2 DIA measuring value is below lower alarm limit.	User-selectable
P2 MAP High	P2 MAP measuring value is above upper alarm limit.	User-selectable
P2 MAP Low	P2 MAP measuring value is below lower alarm limit.	User-selectable
EtCO <sub>2</sub> High	EtCO <sub>2</sub> measuring value is above upper alarm limit.	User-selectable
EtCO <sub>2</sub> Low	EtCO <sub>2</sub> measuring value is below lower alarm limit.	User-selectable
FiCO <sub>2</sub> High	FiCO <sub>2</sub> measuring value is above alarm limits.	User-selectable
CO <sub>2</sub> APNEA	In the set apnea alarm delay time interval, no RESP can be detected using CO <sub>2</sub> module.	High
AwRR High	AwRR measuring value is above upper alarm limit.	User-selectable
AwRR Low	AwRR measuring value is below lower alarm limit.	User-selectable
EtCO <sub>2</sub> (AG) High	EtCO <sub>2</sub> (AG) measuring value is above upper alarm limit.	User-selectable
EtCO <sub>2</sub> (AG) Low	EtCO <sub>2</sub> (AG) measuring value is below lower alarm limit.	User-selectable
FiCO <sub>2</sub> (AG) High	FiCO <sub>2</sub> (AG) measuring value is above alarm limits.	User-selectable
AwRR (AG) High	AwRR (AG) measuring value is above upper alarm limit.	User-selectable
AwRR (AG) Low	AwRR (AG) measuring value is below lower alarm limit.	User-selectable
EtO <sub>2</sub> High	EtO <sub>2</sub> measuring value is above upper alarm limit.	User-selectable
EtO <sub>2</sub> Low	EtO <sub>2</sub> measuring value is below lower alarm limit.	User-selectable
FiO <sub>2</sub> High	FiO <sub>2</sub> measuring value is above upper alarm limit.	User-selectable
FiO <sub>2</sub> Low	FiO <sub>2</sub> measuring value is below lower alarm limit.	User-selectable
EtN <sub>2</sub> O High	EtN <sub>2</sub> O measuring value is above upper alarm limit.	User-selectable
EtN <sub>2</sub> O Low	EtN <sub>2</sub> O measuring value is below lower alarm limit.	User-selectable
FiN <sub>2</sub> O High	FiN <sub>2</sub> O measuring value is above upper alarm limit.	User-selectable
FiN <sub>2</sub> O Low	FiN <sub>2</sub> O measuring value is below lower alarm limit.	User-selectable
EtHAL High	EtHAL measuring value is above upper alarm limit.	User-selectable
EtHAL Low	EtHAL measuring value is below lower alarm limit.	User-selectable
FiHAL High	FiHAL measuring value is above upper alarm limit.	User-selectable
FiHAL Low	FiHAL measuring value is below lower alarm limit.	User-selectable



<b>Message</b>	<b>Cause</b>	<b>Alarm level</b>
EtENF High	EtENF measuring value is above upper alarm limit.	User-selectable
EtENF Low	EtENF measuring value is below lower alarm limit.	User-selectable
FiENF High	FiENF measuring value is above upper alarm limit.	User-selectable
FiENF Low	FiENF measuring value is below lower alarm limit.	User-selectable
EtISO High	EtISO measuring value is above upper alarm limit.	User-selectable
EtISO Low	EtISO measuring value is below lower alarm limit.	User-selectable
FiISO High	FiISO measuring value is above upper alarm limit.	User-selectable
FiISO Low	FiISO measuring value is below lower alarm limit.	User-selectable
EtSEV High	EtSEV measuring value is above upper alarm limit.	User-selectable
EtSEV Low	EtSEV measuring value is below lower alarm limit.	User-selectable
FiSEV High	FiSEV measuring value is above upper alarm limit.	User-selectable
FiSEV Low	FiSEV measuring value is below lower alarm limit.	User-selectable
EtDES High	EtDES measuring value is above upper alarm limit.	User-selectable
EtDES Low	EtDES measuring value is below lower alarm limit.	User-selectable
FiDES High	FiDES measuring value is above upper alarm limit.	User-selectable
FiDES Low	FiDES measuring value is below lower alarm limit.	User-selectable
AG FiO <sub>2</sub> Low	FiO <sub>2</sub> measure value is extremely low.	High
AG APNEA	In the set apnea alarm delay time interval, no RESP can be detected using AG module.	High
TB High	TB measuring value is above upper alarm.	User-selectable
TB Low	TB measuring value is below lower alarm.	User-selectable

## 5.2 Technical Alarm Information

### NOTE:

The ECG alarm information listed in the below table describes the lead names in America. For the corresponding lead names in Europe, please refer to Section *Installing Electrodes*.

Message	Cause	Alarm Level	Action Taken
ECG Lead Off	1) The drive lead or more than one ECG limb electrode falls off the skin; 2) ECG cables fall off the monitor.	Low	Make sure that all electrodes, leads and patient cables are properly connected.
ECG V Lead Off	ECG electrode V falls off the skin or the ECG cable V falls off the monitor.	Low	
ECG LL Lead Off	ECG electrode LL falls off the skin or the ECG cable LL falls off the monitor.	Low	
ECG LA Lead Off	ECG electrode LA falls off the skin or the ECG cable LA falls off the monitor.	Low	
ECG RA Lead Off	ECG electrode RA falls off the skin or the ECG cable RA falls off the monitor.	Low	
ECG Signal Exceed	ECG measuring value is beyond measuring range.	High	Check lead connection and patient condition
ECG Signal Overflow	The amplitude of ECG signal is too wide.	Low	Please modify the ECG gain.

Message	Cause	Alarm Level	Action Taken
ECG Comm Fail	ECG module failure or communication failure	High	Stop measuring function of ECG module, and notify biomedical engineer or manufacturer's service staff.
ECG Noise	ECG measuring signal is greatly interrupted.	Low	Check lead connection and patient condition
ECG V1 Lead Off	ECG electrode V1 falls off the skin or the ECG cable V1 falls off.	Low	Make sure that all electrodes, leads and patient cables are properly connected.
ECG V2 Lead Off	ECG electrode V2 falls off the skin or the ECG cable V2 falls off.	Low	
ECG V3 Lead Off	ECG electrode V3 falls off the skin or the ECG cable V3 falls off.	Low	
ECG V4 Lead Off	ECG electrode V4 falls off the skin or the ECG cable V4 falls off.	Low	
ECG V5 Lead Off	ECG electrode V5 falls off the skin or the ECG cable V5 falls off.	Low	
ECG V6 Lead Off	ECG electrode V6 falls off the skin or the ECG cable V6 falls off.	Low	
RESP Comm Fail	RESP module failure or communication failure	High	Stop measuring function of RESP module, and notify biomedical engineer or the manufacturer's service staff.

Message	Cause	Alarm Level	Action Taken
RR Exceed	RR measuring value is out of the measure range (less than 6rpm or greater than 150rpm).	Medium	Check whether interference to the respiratory signal exists. And check whether the patient is breathing normally; breathing too rapidly or too slowly may endanger patient's life.
RESP Cardiac Artifact	No RESP waveform can be detected due to apnea or shallow breathing of the patient.	High	Check whether the patient is breathing normally. Take measures to help the patient breathe normally when necessary. If the patient is breathing normally, try to adjust the electrode position on the patient in order to reduce the interference of cardiogenic artifact.
RESP Noise	RR cannot be measured due to patient movement.	Low	Check whether the RESP leads are well connected. Keep the patient calm for better monitoring.
SpO <sub>2</sub> Sensor Off	SpO <sub>2</sub> sensor may be disconnected from the patient or the monitor.	Low	Make sure the sensor is well connected to the patient's finger or other parts.
SpO <sub>2</sub> Sensor Err	Malfunction in the SpO <sub>2</sub> sensor or in the extension cable.	Low	Replace the SpO <sub>2</sub> sensor or the extension cable.
SpO <sub>2</sub> No Sensor	SpO <sub>2</sub> sensor was not connected well or connected to the monitor, or the connection is loose.	Low	Make sure the monitor and sensor is well connected, reconnect the sensor.

Message	Cause	Alarm Level	Action Taken
SpO <sub>2</sub> Comm Fail	SpO <sub>2</sub> module failure or communication failure	High	Stop using measuring function of SpO <sub>2</sub> module, and notify biomedical engineer or manufacturer's service staff.
SpO <sub>2</sub> Low Perfusion	The pulse signal is too weak or the perfusion of the measurement site is too low	Low	Reconnect the SpO <sub>2</sub> sensor and change the measurement site. If problem exists, please notify biomedical engineer or manufacturer's service staff.
SpO <sub>2</sub> Noisy Signal	There is interference with SpO <sub>2</sub> measurement signals and the waveform is abnormal.	Low	Check the condition of patient and avoid patient movement; make sure the cable is well connected.
SpO <sub>2</sub> Light Interference	Ambient light around the sensor is too strong.	Low	Reduce interference of the ambient light and avoid sensor's exposure to strong light.
NIBP Comm Fail	NIBP module failure or communication failure	High	Stop using measuring function of NIBP module, and notify biomedical engineer or manufacturer's service staff.

Message	Cause	Alarm Level	Action Taken
NIBP Leak	NIBP pump, valve, cuff or tube has a leakage.	Low	Properly wrap the cuff and connect the tube. Measure again; if failure persists, stop measuring function of NIBP module and notify biomedical engineer or manufacturer's service staff.
NIBP Excessive Pressure	Pressure has exceeded the specified upper safety limit.	Low	Measure again, if failure persists, stop measuring function of NIBP module and notify biomedical engineer or manufacturer's service staff.
NIBP Init Pressure High	The initial pressure is too high during measuring	Low	Measure again, if failure persists, stop measuring function of NIBP module and notify biomedical engineer or manufacturer's service staff.
NIBP Self Test Error	Sensor or other hardware errors.	High	If failure persists, stop using measuring function of NIBP module and notify biomedical engineer or manufacturer's service staff.
NIBP Cuff Type Error	The cuff type used isn't consistent with the patient type.	Low	Confirm the patient type and change the cuff.

Message	Cause	Alarm Level	Action Taken
Air Pressure Error	Malfunction in pressure sensor or valve	Low	Check whether the airway is occluded or pressure sensor works properly. If the problem still exists, contact your service personnel.
NIBP System Failure	Malfunction in hardware	High	Contact your service personnel.
NIBP Weak Signal	Cuff is too loose or patient pulse is too weak.	Low	Check the connection of the cuff and try again. If failure persists, use other methods to measure blood pressure.
NIBP Range Exceeded	Maybe the patient blood pressure value is beyond the measurement range.	Low	Use other methods to measure blood pressure.
NIBP Loose Cuff	Cuff is not properly wrapped or no cuff is connected.	Low	Properly wrap the cuff.
NIBP Interference	Signal noise is too large or pulse rate is not regular.	Low	Make sure that the patient under monitoring is motionless.
HW Excessive Pressure	Hardware excessive pressure protection	High	Notify biomedical engineer or manufacturer's service staff.
NIBP Time Out	Measuring time has exceeded the specified time.	Low	Measure again or use other measuring methods.
TEMP T1 Sensor Off	Temperature cable of TEMP channel 1 may be disconnected from the monitor.	Low	Make sure that the cable is properly connected

Message	Cause	Alarm Level	Action Taken
TEMP T2 Sensor Off	Temperature cable of TEMP channel 2 may be disconnected from the monitor.	Low	Make sure that the cable is properly connected.
Excessive T1	TEMP1 measuring value is beyond measuring range.	High	Check sensor connection and patient condition
Excessive T2	TEMP2 measuring value is beyond measuring range.	High	Check sensor connection and patient condition
TEMP Comm Fail	TEMP module failure or communication failure.	High	Stop measuring function of TEMP module, and notify biomedical engineer or Manufacturer's service staff.
YY Sensor Off (YY stands for the IBP label name)	IBP sensor falls off.	Low	Check the sensor connection and reconnect the sensor.
YY Comm Fail (YY stands for the label name)	IBP module failure or communication failure	High	Stop measuring function of IBP module, and notify biomedical engineer or Manufacturer's service staff.
C.O. Comm Fail	C.O. module failure or communication failure	High	Stop measuring of C.O. module, or notify biomedical engineer or Manufacturer's service staff.
C.O. TI No Sensor	C.O. TI sensor not connected	Low	Insert injective temperature sensor.
C.O. TB No Sensor	C.O. TB sensor not connected	Low	Insert TB sensor.
TEMP Out Of Range	TB measuring value is above measuring range.	High	Please check TB sensor.



Message	Cause	Alarm Level	Action Taken
C.O. Lack Param	C.O. measuring needs parameters	High	Please input patient's height and weight.
AA Out Of Range	The AA concentration exceeds the accuracy range of AG module.	High	Reduce AA concentration.
O <sub>2</sub> Sensor Error	The oxygen sensor of the sidestream AG module has a failure.	Medium	Stop measuring of AG module, and notify biomedical engineer or Manufacturer's service staff.
AG Comm Fail	AG module failure or communication failure.	High	Stop measuring function of AG module, and notify biomedical engineer or Manufacturer's service staff.
AG Zero Required	AG module requires zero.	Low	Please perform zeroing.
AG Self-Testing	AG module is self testing.	Low	Please wait the self testing finishing.
AG Replace O <sub>2</sub> Sensor	O <sub>2</sub> sensor needs to be replaced.	High	Please replace the O <sub>2</sub> sensor.
AG Check Adapter	AG module checks adapter.	Low	Please wait check finishing.
O <sub>2</sub> Cali Required	O <sub>2</sub> needs to be calibrated.	Low	Please calibrate O <sub>2</sub> .
AG Software Error	AG module software abnormal	High	Please replace software revision.
AG Hardware Error	AG module has hardware failure.	High	Please check whether the hardware work properly.
AG Motor Error	AG module motor abnormal	High	Please check whether the motor works properly.
AG Uncalibrated	AG module uncalibrated	Low	Please calibrate the AG module.
AG Replace Adapter	AG module needs to change adapter.	High	Please replace the adapter.

Message	Cause	Alarm Level	Action Taken
O <sub>2</sub> Out Of Range	O <sub>2</sub> is out of range.	High	Please make O <sub>2</sub> range resume normal.
AG TEMP Out Of Range	AG module temperature out of range	High	Please make the temperature resume normal.
AG Baro Press Out Of Range	AG module baro pressure out of pressure	High	Please make the baro pressure value resume normal.
AG AA Id Unreliable	AG module can't identify the AG agent.	Medium	Reduce gas agent type.
AG Span Calib In Progress	AG module is calibrating.	Low	Please wait calibration finishing.
AG Calibration Fail	AG module calibration failure	Medium	Please check whether the module works properly.
Unable To Calibrate	AG module can't be calibrated.	Medium	Please check whether the module works properly.
AG Zero In Progress	AG module is zeroing.	Low	Please wait zeroing.
AG Occlusion	The sampling line is clogged.	Medium	Replace the sampling line.
AG Init Fail	AG module has a failure.	High	AG module works improperly.
AG Data Limit Error	AG module has a failure.	High	AG module works improperly.
AG Usa Error	AG module has a failure.	High	AG module works improperly.
AG Cal Fail	AG module fails to calibrate.	High	AG module works improperly.
AG Zref Fail	AG module fails to zero.	High	AG module works improperly.
AG Change Oxygen Sensor	Replace oxygen sensor of AG module.	Low	Please wait changing finishing.
AG No Oxygen Sensor	The oxygen sensor falls off from the AG module.	High	Connect the sensor again.

Message	Cause	Alarm Level	Action Taken
AG Mixed Agents	AG module detects mixture gas agent.	Medium	Close the subsidiary gas agent.
CO <sub>2</sub> Occlude	Water trap of SideStream is occluded.	High	Make sure the gas exhaust works well
CO <sub>2</sub> Out Of Range	The CO <sub>2</sub> concentration exceeds the accuracy range of EDAN CO <sub>2</sub> module.	High	Reduce CO <sub>2</sub> concentration.
CO <sub>2</sub> Sensor Faulty	CO <sub>2</sub> module failure	High	Stop measuring function of CO <sub>2</sub> module, notify biomedical engineer.
CO <sub>2</sub> Sensor Over Temp	CO <sub>2</sub> measure value exceeds the measure range of the monitor.	High	Stop measuring function of CO <sub>2</sub> module, notify biomedical engineer.
CO <sub>2</sub> Comm. Failed	CO <sub>2</sub> module failure or communication failure	High	Check if the water tray has been fixed.
CO <sub>2</sub> Zero Required	Zero calibration failure	Low	Disconnect the sampling cannula or adapter from the airway; initiate the zeroing before making sure that no expired air is inside the sampling cannula and adapter.
CO <sub>2</sub> Check Adapter	<p>1) For the Respirationics CO<sub>2</sub> module: The cannula is off or disconnected.</p> <p>2) For the EDAN CO<sub>2</sub> module: The water trap is disconnected or not properly connected.</p>	Low	<p>1) For the Respirationics CO<sub>2</sub> module: Check whether the adapter is properly connected or replace the adapter.</p> <p>2) For the EDAN CO<sub>2</sub> module: Properly connect the water trap.</p>

Message	Cause	Alarm Level	Action Taken
AA Out Range	The AA concentration exceeds the accuracy range of AG module.	High	Reduce AA concentration.
O <sub>2</sub> Sensor Error	The oxygen sensor of the sidestream AG module has a failure.	Medium	Stop measuring of AG module, and notify biomedical engineer or Manufacturer's service staff.
QuickTemp Comm Fail	TEMP module failure or communication failure.	High	Stop measuring function of TEMP module, and notify biomedical engineer or manufacturer's service staff.
Temp exceed limit	The TEMP value is beyond the range of +25°C ~ +45°C.	Med	Put the sensor into the sensor bracket, take it out and measure again.
No Temp Sensor	TEMP sensor is not connected to the TEMP module.	Low	Connect the sensor and the monitor well, and measure again.
Ambient temp too high	The Sensor temperature is higher than +40°C.	Low	Put the sensor into the sensor bracket, measure again after the ambient temperature reaches normal value.
Ambient temp too low	The Sensor temperature is lower than +10°C.	Low	Put the sensor into the sensor bracket, measure again after the ambient temperature reaches normal value.

Message	Cause	Alarm Level	Action Taken
Probe data error	Offline: NTC resistance $>R + 0\text{ }^{\circ}\text{C}$ ; Short: NTC resistance $<R + 100\text{ }^{\circ}\text{C}$ .	Med	Put the sensor into the sensor bracket, take it out and measure again. If the problem persists, stop using measuring function of TEMP module, and notify biomedical engineer or manufacturer's service staff.
Probe heater error	Single failure	Med	Put the sensor into the sensor bracket, take it out and measure again. If the problem persists, stop using measuring function of TEMP module, or notify biomedical engineer or manufacturer's service staff.
Probe temp too high	The original temperature of sensor $>+33\text{ }^{\circ}\text{C}$ & $\leq+40\text{ }^{\circ}\text{C}$ .	Low	Put the sensor into the sensor bracket, measure again after the sensor temperature reaches normal value.
Temp Sensor Off	After the sensor temperature reaches Predict value, it descends to the value lower than Predict value.	Med	Reconnect the sensor and make sure that the cable is properly connected.
Battery Low	Battery Low	High	Please change the battery or charging.
Recorder Out Of Paper	Recorder Out Of Paper	Low	Please install the paper

Message	Cause	Alarm Level	Action Taken
Recorder setup needed	The user presses the <b>RECORD</b> button when the monitor is not installed with a recorder.	Low	Notify the manufacturer's service staff to install and set the recorder.
Removable device is full	Less than 10M space is left in the removable device.	Low	Delete some data in the removable device or use another removable device.
Removable dev read-only	The removable device is read-only.	Low	Repair the removable device or replace it with a new one.

### 5.3 Prompts

Message	Cause
ECG Arr Learning	The QRS template building required for Arr. Analysis is in process.
SpO <sub>2</sub> Search Pulse	SpO <sub>2</sub> module is analyzing the patient signal and searching for the pulse to compute the saturation, when sensor is connected with patient.
Manual Measuring	In manual measuring mode
Continual Measuring	In continuous measuring mode
Auto Measuring	In automatic measuring mode
Measure Abort	Measurement over
Calibrating	During calibrating
Calibrate Abort	Calibration over
Leak Testing	During pneumatic test
Leak Test Ok	NIBP module has passed leak test.
Leak Test Abort	Pneumatic test over
Resetting	NIBP module in resetting
Please Start	NIBP module is in idle status.
Done	NIBP measurement successfully done
Continual Measuring	NIBP module performs continual measuring
Stat Measuring	NIBP module performs STAT function.

Message	Cause
Please Switch To Maintain Mode	NIBP module is in normal mode, the user can't start leak test and pressure calibration. Please enter <b>User Maintain &gt; NIBP Maintain</b> and switch to <b>Maintain Mode</b> to perform leak test or pressure calibration.
Please Switch To Normal Mode	NIBP module is in maintaining mode, the user can't start blood pressure measurement. Please enter <b>User Maintain &gt; NIBP Maintain</b> and switch to <b>Normal Mode</b> to perform blood pressure measurement.
Quick TEMP Is Warming Up	Quick TEMP Is Warming Up.
Place Probe On Measure Place	Probe isn't placed on the measurement site.
CO <sub>2</sub> Standby	Turn from measuring mode to standby mode, making the module in energy-saving status.
CO <sub>2</sub> Sensor Warm Up	The CO <sub>2</sub> module is in warm-up state.
Zeroing...	The CO <sub>2</sub> module is performing the zero calibration.
Excessive C.O. Temp	TB measuring value is beyond measuring range.
Excessive Temp, C.O. Measurement Fail.	C.O. measuring needs parameters.
C.O. measure need param	HEMOD calculation needs parameters.
Insufficient factors for Hemod Dynamics	HEMO Dynamics calculation needs parameters.
No Sensor, C.O. measurement fail	No Sensor,C.O. measurement fail
Measuring...	The C.O. module is performing measuring.
Ready for new measurement	C.O. module is ready for new measurement.
Invalid C.O. result	C.O. measurement result is invalid.
C.O. Measurement Complete	C.O. Measurement is completed.
C.O. Measurement Abort	C.O. Measurement is aborted.
Warm-up over	The monitor displays this message after taking the sensor out of the bracket and warm-up is over.
Measure over	After the Predict measuring is over, the data and message display on the interface.
Measure time out	No measuring result after the module entering Predict state for 30s.
AG Standby	AG module is operating in the standby status.

## 5.4 Adjustable Range of Alarm Limits

ECG alarm limits are listed as follows: unit (bpm)

	Patient Type	ALM HI	ALM LO
HR	ADU	300	15
	PED	350	15
	NEO	350	15

ST analysis alarm limits are listed as follows: unit (mV)

	ALM HI	ALM LO
ST	2.0	-2.0

PVCs alarm upper limits are listed as follows:

	ALM HI	ALM LO
PVCs	10	



RESP alarm limits are listed as follows: unit (rpm)

Patient Type	ALM HI	ALM LO
ADU	120	6
PED	150	6
NEO	150	6

SpO<sub>2</sub> alarm limits are listed as follows (unit %):

	ALM HI	ALM LO
SpO <sub>2</sub>	100	0

PR alarm limits is listed as follows: unit (bpm)

	ALM HI	ALM LO
PR	300	30

NIBP alarm limits are listed as follows (EDAN module): unit (mmHg)

Patient Type		ALM HI	ALM LO
ADU	SYS	270	40
	DIA	215	10
	MAP	235	20
PED	SYS	200	40
	DIA	150	10
	MAP	165	20
NEO	SYS	135	40
	DIA	100	10
	MAP	110	20

NIBP alarm limits are listed as follows (Omron module): unit (mmHg)

Patient Type		ALM HI	ALM LO
ADU(PED)	SYS	250	60
	DIA	200	40
	MAP	235	45
NEO	SYS	120	40
	DIA	90	20
	MAP	100	30

TEMP alarm limits are listed as follows:

	ALM HI	ALM LO
T1	50°C (122 ° F)	0°C (32 ° F)
T2	50°C (122 ° F)	0°C (32 ° F)
TD	50°C (90 ° F)	0°C (0 ° F)

IBP alarm limits are listed as follows: unit (mmHg)

	ALM HI	ALM LO
Art	300	0
RAP	40	-10
LAP	40	-10
CVP	40	-10
PA	120	-6
ICP	40	-10
P1	300	-50
P2	300	-50

CO<sub>2</sub> alarm limits are listed as follows:

	ALM HI	ALM LO
EtCO <sub>2</sub>	150 mmHg	0
FiCO <sub>2</sub>	50 mmHg	3
AwRR	150 rpm	2 rpm

C.O. alarm limits are listed as follows:

	ALM HI	ALM LO
TB	43°C (109.4°F)	23°C(73.4°F)

Quick Temp alarm limits are listed as follows:

Patient Type	ALM HI	ALM LO
ADU	42°C (107.6°F)	35.5°C (95.9°F)
PED	42°C (107.6°F)	35.5°C (95.9°F)

AG alarm limits are listed as follows:

Patient Type		ALM HI	ALM LO
ADU	FiCO <sub>2</sub>	25.0%	0.0%
	EtCO <sub>2</sub>	25.0%	0.0%
	FiO <sub>2</sub>	88.0%	18.0%
	EtO <sub>2</sub>	90.0%	18.0%
	FiN <sub>2</sub> O	100.0%	0.0%
	EtN <sub>2</sub> O	100.0%	0.0%
	EtDes	18.0%	0%
	FiDes	18.0%	0%
	EtIso	5.0%	0%
	FiIso	5.0%	0%
	EtHal	5.0%	0%
	FiHal	5.0%	0%
	EtSev	8.0%	0%
	FiSev	8.0%	0%
	EtEnf	5.0%	0%
	FiEnf	5.0%	0%
	awRR	150 rpm	0 rpm
	Apnea Time	40s	20s
	PED	FiCO <sub>2</sub>	25.0%
EtCO <sub>2</sub>		25.0%	0.0%
FiO <sub>2</sub>		88.0%	18.0%
EtO <sub>2</sub>		90.0%	18.0%
FiN <sub>2</sub> O		100.0%	0.0%
EtN <sub>2</sub> O		100.0%	0.0%
EtDes		18.0%	0%
FiDes		18.0%	0%
EtIso		5.0%	0%
FiIso		5.0%	0%
EtHal		5.0%	0%
FiHal		5.0%	0%

	EtSev	8.0%	0%
	FiSev	8.0%	0%
	EtEnf	5.0%	0%
	FiEnf	5.0%	0%
	awRR	150 rpm	0 rpm
	Apnea Time	40s	20s
NEO	FiCO <sub>2</sub>	25.0%	0.0%
	EtCO <sub>2</sub>	25.0%	0.0%
	FiO <sub>2</sub>	88.0%	18.0%
	EtO <sub>2</sub>	90.0%	18.0%
	FiN <sub>2</sub> O	100.0%	0.0%
	EtN <sub>2</sub> O	100.0%	0.0%
	EtDes	18.0%	0%
	FiDes	18.0%	0%
	EtIso	5.0%	0%
	FiIso	5.0%	0%
	EtHal	5.0%	0%
	FiHal	5.0%	0%
	EtSev	8.0%	0%
	FiSev	8.0%	0%
	EtEnf	5.0%	0%
	FiEnf	5.0%	0%
	awRR	150 rpm	0 rpm
	Apnea Time	40 s	20 s

## Chapter 6 Managing Patients

### 6.1 Admitting a Patient

The monitor displays physiological data and stores it in the trends as soon as a patient is connected. This allows you monitor a patient who is not yet admitted. It is however important to admit patients properly so that you can identify your patient on recordings, reports, and networked devices.

During admission you enter data that the monitor needs for safe and accurate operation. For example, the patient category setting determines the algorithm the monitor uses to process and calculate some measurements, the safety limits that are applied for some measurements, and the alarm limit ranges.

To admit a patient, please:

1. Select the **Admission** key on the screen or.
2. Select **Menu > Patient Setup > New Patient**, then a message is displayed to ask the user to confirm to update patient.
3. Click on **No** to cancel this operation; click on **Yes**, the **Patient Info** window is displayed.
4. Enter the patient information:
  - **Serial No**: Enter the patient's medical record number (MRN), for example 12345678.
  - **Last name**: Enter the patient's last name (family name), for example Smith.
  - **First name**: Enter the patient's first name, for example Joseph.
  - **Gender**: **Male**, **Female** and **N/A**.
  - **Type**: Choose the patient type, either **Adult**, **Pediat**, or **Neonat**.
  - **BloodType**: **N/A**, **A**, **B**, **AB** and **O**.
  - **Pace**: Choose **On** or **Off** (You must select **On** if your patient has a pacemaker).
  - **Date of Birth**: Enter the patient's date of birth.
  - **Date of Admission**: Enter the patient's date of admission.
  - **Height**: Enter the patient's height.
  - **Weight**: Enter the patient's weight.
  - **Doctor**: Enter the attending doctor for the patient.

#### 6.1.1 Patient Category and Paced Status

The patient category setting determines the algorithm the monitor uses to process and calculate some measurements, the safety limits that are applied for some measurements, and the alarm limit ranges.

The paced setting determines whether the monitor shows pacemaker pulses or not. When **Pace** is set to **Off**, pace pulses are filtered and therefore do not show in the ECG wave.

---

**WARNING**

---

- 1 Changing the patient category may change the arrhythmia and NIBP alarm limits. Always check alarm limits to make sure that they are appropriate for your patient.
  - 2 For paced patients, you must set Paced to On. If it is incorrectly set to Off, the monitor could mistake a pace pulse for a QRS and fail to give an alarm during asystole.
- 

## 6.2 Quick Admit

If you do not have the time or information to fully admit a patient. Complete the rest of the patient information later. To quickly admit a patient, please:

1. Select **Menu > Patient Setup > Quick Admit**, then a message is displayed to ask the user to confirm to update patient.
2. Click on **No** to cancel this operation; click on **Yes** to continue and the **Patient Info** window is displayed, choose **Type** and **Pace** and set them to the correct mode.
3. Select **Exit**.

## 6.3 Editing Patient Information

To edit the patient information after a patient has been admitted, select **Menu > Patient Setup > Patient Info.**, and make the required changes on the popup interface.

## 6.4 Updating a Patient

You should always perform an update before starting monitoring for a new patient. When you select **Menu > Patient Setup > Quick Admit**, or **Menu > Patient Setup > New Patient**, a message of **Press ‘Yes’ to create new patient profile by clearing all current patient data...** is displayed.

- If the user selects **Yes**, the monitor will update the patient information.
- If the user selects **No**, the monitor won't update the patient information and returns to patient setup interface.

**NOTE:**

Discharging patient will clear the history data in the monitor associated with the patient.

## 6.5 Central Monitoring System

The monitor can be connected to the central monitoring system. Through the network:

1. The monitor sends patient information, real-time monitoring or measurement data to the central monitoring system.
2. The real-time monitoring information is displayed on the central monitoring system as the

same to the monitor, and the central monitoring system can perform some bilateral control. For example: changing patient information, alarm limit and so forth.

For detailed information, please refer to *MFM-CMS Central Monitoring System User Manual* and *CNS Central Monitoring System User Manual*.

And the monitor supports HL 7 protocol.

**NOTE:**

- 1 Make sure the network connection between the monitor and the central monitoring system is in good condition when the time synchronization function on the monitor is active.
- 2 The time synchronization function might not be available to all software versions of MFM-CMS. Consult our technical service department or your local distributor for more information.

## Chapter 7 User Interface

### 7.1 Setting Interface Style

The user can set the interface based on the requirement, and the set options include the following:

- Sweep of the waveform.
- Parameters needing to be monitored.

Change to some settings may have the risk, so only the authorized person can change them. After changing the settings, please notify the operator.

### 7.2 Selecting Display Parameters

The user can select the display parameters based on the monitoring and measurement requirements. To select the parameter, please:

1. Select **Menu > System Setup > Module Switch**.
2. Select the required parameters from the popup interface.
3. Press **Exit** to exit the menu and the screen will adjust the parameters automatically.

### 7.3 Changing Waveform Position

The user can exchange the waveform positions of parameter A and parameter B, please refer to the following steps to do so:

1. Select waveform A and open the setup menu of waveform A.
2. Select **Change** from the popup menu and select the desired label name of waveform B from the pull-down list.

### 7.4 Changing Interface Layout

To change the interface layout, please refer to the following steps:

1. Select **Menu > Display Setting**.
2. Select one interface from the popup menu.
3. The user can implement one kind of function screen based on the requirements. If the user selects the **Large Font** option, there is no function screen to be selected.

### 7.5 Viewing Trend Screen

To view the short trend screen, the user can press the **Trend Screen** key on the screen directly or select **Menu > Display Setting > View Selection > TrendScreen**.



## 7.6 Viewing Oxygen Screen

To view the oxygen screen, the user can press the **oxyCRG** key on the screen or select **Menu > Display Setting > View Selection > oxyCRG**. This interface is always used in NICU because the SpO<sub>2</sub>, HR and Resp of the neonate are different from those of adults.

## 7.7 Viewing Large Font Screen

To open the large font screen, please refer to the following steps:

1. Select the **Large Font** key on the screen directly or.
2. Select **Menu > Display Setting > View Selection > Large Font** to open this interface.

To view the large font interface of specific parameter, please select the parameter pull-down dialog on the interface (the red circle shown in the following figure).

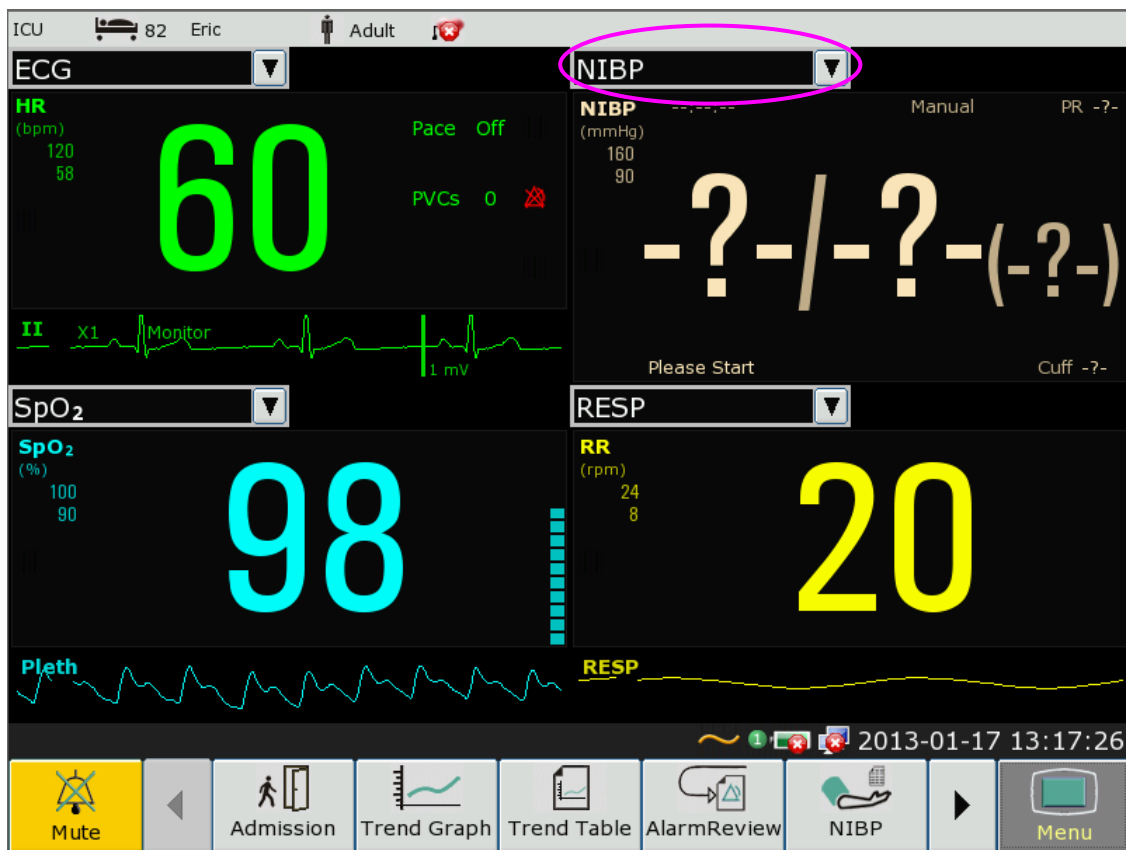

## 7.8 Viewing the Bed View Window

The **Bed View** window allows you to view one waveform, numeric information of all parameters and alarm information from another bed on the same network. The monitor enables a maximum of eight beds to be viewed.

### NOTE:



- 1 The IP addresses of the monitors configured with bed view function should share the same network segment. The IP addresses of the monitors on the same LAN should be unique from each other; you cannot use the bed view function in the monitors in which an IP address conflict exists.
- 2 To use the bed view function smoothly, make sure the network connection is in good condition.
- 3 In the **Bed View** window, you cannot view the over-limit alarms of physiological parameters occurring on other beds. Besides, arrhythmia alarms and vital alarms will be indicated only by alarm icons.

### 7.8.1 Opening the Bed View Window

Before opening the **Bed View** window, make sure the bed view function is configured on your monitor. To open the **Bed View** window, select **Menu > Display Setup** and choose **Bed View** in the **View Selection** list.

### 7.8.2 Settings of the Bed View Window

Click on the **Bed View** window to open the **ViewBed Setup** menu on which you can

- Assign a bed to be viewed by selecting the bed No. in the **Bed No.** list.
- Select the waveform to be displayed on the window in the **Wave Type** list.
- Use the buttons  and  to view more numeric information of parameters in the window.

## 7.9 Changing Parameter and Waveform Colors

The user can set the display colors of parameter and waveform as desire. To change the display color, please select **Menu > Maintenance > User Maintain**, enter the required password **ABC**. Then select **Color Select** to make color changes on parameter and color.

## 7.10 User Configuration

Users can save the current monitor's configuration, delete the saved user configuration and rename it. Three pieces of user configuration can be saved in the monitor.

To save the user configuration:

1. Select **Menu > Maintenance > User Maintain**, enter the required password **ABC** and then select **User Configure**.
2. Click on **Save**, enter a file name for the configuration and confirm it. A message will display after the operation.

To delete the user configuration:

1. Select **Menu > Maintenance > User Maintain**, enter the required password **ABC** and then select **User Configure**.
2. Select the configuration file needed to delete from the list, click on **Delete** and confirm the operation. A message will display after the operation.

To rename the user configuration:

1. Select **Menu > Maintenance > User Maintain**, enter the required password **ABC** and then select **User Configure**.
2. Select a configuration file needed to rename from the list and click on **Rename**.
3. Enter a name for the configuration file and confirm it.

## 7.11 Default Configuration

To set default configuration, please select **Menu > Default** and choose a configuration (adult, pediatric or neonate) based on your patient category. This configuration is factory configuration.

## Chapter 8 Monitoring ECG

### 8.1 Overview

The electrocardiogram (ECG) measures the electrical activity of the heart and displays it on the monitor as a waveform and a numeric. This chapter also tells you about arrhythmia monitoring and ST monitoring.

### 8.2 ECG Safety Information

---

**WARNING**

---

- 1 Do not come into contact with the patient, table, or the monitor during defibrillation.
  - 2 Only use the ECG leads supplied by the manufacturer when using the monitor for ECG monitoring.
  - 3 When connecting the cables and electrodes, make sure no conductive part is in contact with the ground. Verify that all ECG electrodes, including neutral electrodes, are securely attached to the patient but not the conductive part or ground.
  - 4 Check every day whether there is skin irritation resulted from the ECG electrodes. If yes, replace electrodes every 24 hours or change their sites.
  - 5 Place the electrode carefully and ensure a good contact.
  - 6 Check if the lead connection is correct before monitoring. If you unplug the ECG cable from the socket, the screen will display the error message "ECG LEAD OFF" and the auditory alarm is activated.
  - 7 When using the monitor with the defibrillator or other high-frequency equipment, please use defibrillator-proof ECG lead to avoid burn.
  - 8 In order to avoid being burnt, please keep the electrodes far away from the radio knife while using electrosurgical equipment.
  - 9 When using Electrosurgery (ES) equipment, do not place an electrode near the grounding plate of the Electrosurgery device: otherwise there will be a great deal of interference with the ECG signal.
  - 10 For patients with pacemakers, the pacing impulse analysis function must be switched ON. Otherwise, the pacing impulse may be counted as normal QRS complex, which results in failure of ECG LOST error detection.
  - 11 The electrodes should be made of the same metal materials.
  - 12 ECG cables can be damaged when connected to a patient during defibrillation. Check cables for functionality before using them again.
  - 13 ECG accessories are not suitable for DIRECT CARDIAC APPLICATION. (Refer to IEC60601-1 for more information about the definition of DIRECT CARDIAC APPLICATION.)
-

**NOTE:**

- 1 Interference from a non-grounded instrument near the patient and ESU interference can cause inaccuracy of the waveform.
- 2 IEC/EN60601-1-2 (protection against radiation is 3v/m) specifies that the electrical field density exceeding 1v/m may cause measurement error in various frequencies. It is accordingly suggested that do not use equipment generating electrical radiation near ECG/RESP monitoring devices.
- 3 The simultaneous use of cardiac pacemaker and other patient-connected equipment may cause safety hazard.
- 4 If the pacemaker signals are beyond the claimed range, the heart rate may be calculated incorrectly.
- 5 In the default settings of the monitor, the ECG waveforms are the first two waveforms from top in the waveform area.
- 6 For measurements in or near the heart we recommend connecting the monitor to the potential equalization system.
- 7 For protecting environment, the used electrodes must be recycled or disposed of properly.

## 8.3 ECG Display

The figure below is for reference only.

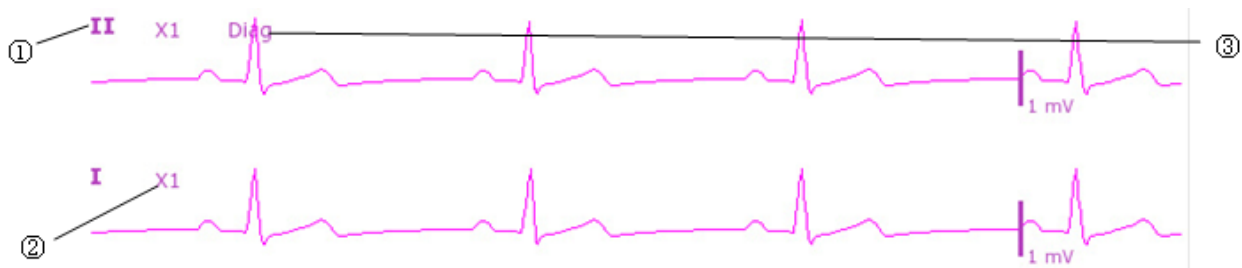

The symbol “①” indicates lead name of display waveform: there are other leads for selection, such as I, II, III, aVR, aVF, aVL, V. If you want to change the lead, please refer to section *Selecting Calculation Lead*.

The symbol “②” indicates waveform gain: there are several options, such as X0.125, X0.25, X0.5, X1, X2, X4 and Auto. If you want to change it, please refer to section *Changing the size of the ECG Wave*.

The symbol “③” indicates Filter setting, there are three options: monitoring, surgery, diagnosis. If you want to change it, please refer to section *Changing the ECG Filter Setting*.

### 8.3.1 Changing the Size of the ECG Wave

If any of the displayed ECG waveform is too small or clipped, you can change the size of it on the screen. First select **ECG Wave Setup** > **ECG Gain**, then select an appropriate factor from the pop-up box to adjust the ECG waveform.

- X0.125** to make strength of ECG signal waveform of 1mV become 1.25mm;
- X0.25** to make strength of ECG signal waveform of 1mV become 2.5mm;
- X0.5** to make strength of ECG signal waveform of 1mV become 5mm;
- X1** to make strength of ECG signal waveform of 1mV become 10mm;
- X2** to make strength of ECG signal waveform of 1mV become 20mm;
- X4** to make strength of ECG signal waveform of 1mV become 40mm;
- Auto** let the monitor choose the optimal adjustment factor for all the ECG waves.

### 8.3.2 Changing the ECG Filter Settings

The ECG filter setting defines how ECG waves are smoothed. An abbreviation indicating the filter type is shown underneath the lead label on the monitor display. Filter settings do not affect ST measurement.

To change the filter setting, in the **ECG Setup** menu, select **Filter** and then select the appropriate setting.

- **Monitor**: Use this mode under normal measurement conditions.
- **Surgery**: The filter reduces interference to the signal. It should be used if the signal is distorted by high frequency or low frequency interference. High frequency interference usually results in large amplitude spikes making the ECG signal look irregular. Low frequency interference usually leads to a wandering or rough baseline. In the operating room, the Filter reduces artifacts and interference from electro-surgical units. Under normal measurement conditions, selecting **Surgery** may suppress the QRS complexes too much and thus interfere with the clinical evaluation of the ECG displayed on the monitor.
- **Diagnos**: Use when diagnostic quality is required. The unfiltered ECG wave is displayed so that changes such as R-wave notching or discrete elevation or depression of the ST segments are visible.

## 8.4 Using ECG Alarms

ECG alarms can be switched on and off and the changes to high and low alarm limits are just like other measurement alarms, which are described in the Alarms section. Special alarm features applying only to ECG are described here.

## 8.5 Selecting Calculation Lead

On the **Normal** interface, the users can select either **3 LEADS** or **5 LEADS** for this item. Normal QRS complex should be:

- The normal QRS should be either completely above or below the baseline and it should not be biphasic. For paced patients, the QRS complexes should be at least twice the height of pace pulses.

- The QRS should be tall and narrow.
- The P-waves and the T-waves should be less than 0.2 mV.

## 8.6 Monitoring Procedure

### 8.6.1 Preparation

The skin is a poor conductor of electricity, therefore preparation of the patient's skin is important to facilitate good electrode contact to skin.

- Select sites with intact skin, without impairment of any kind.
- Shave hair from sites, if necessary.
- Wash sites thoroughly with soap and water. (Never use ether or pure alcohol, because this increases skin impedance).
- Rub the skin briskly to increase capillary blood flow in the tissues and remove skin scurf and grease.

### 8.6.2 Connecting ECG Cables

1. Attach clip or snap to electrodes prior to placement.
2. Put the electrodes on the patient. Before attaching, apply some conductive jelly on the electrodes if the electrodes are not electrolyte self-supplied.
3. Connect the electrode lead to the patient's cable.

---

#### CAUTION

- 1 To protect the monitor from damage during defibrillation, for accurate ECG information and to protect against noise and other interference, use only ECG electrodes and cables specified by EDAN.
  - 2 If the ECG waveforms appear intermittently or there is obvious interference on the ECG signals, it is usually because the patient skin has not been well cleaned or the ECG electrodes are defective. In this situation, please carefully clean the skin and select effective electrodes.
- 

## 8.7 Selecting Lead Type

To change the lead type, please:

1. Select the ECG parameter area, open the **ECG Setup** menu;
2. Set **Lead Type** to **3 Leads**, **5 Leads** or **12 Leads** based on the lead used.

## 8.8 Installing Electrodes

### NOTE:

The following table gives the corresponding lead names used in Europe and America respectively. (Lead names are represented by R, L, F, N, C, C1-C6 in Europe, whose corresponding lead names in America are RA, LA, LL, RL, V, V1-V6.)

AHA (American Standard)		IEC (Europe Standard)	
Electrode Labels	Color	Electrode Labels	Color
RA	White	R	Red
LA	Black	L	Yellow
LL	Red	F	Green
RL	Green	N	Black
V	Brown	C	White
V1	Brown/ Red	C1	White/ Red
V2	Brown/ Yellow	C2	White/ Yellow
V3	Brown/ Green	C3	White/ Green
V4	Brown/Blue	C4	White/ Brown
V5	Brown/Orange	C5	White/ Black
V6	Brown/Purple	C6	White/ Purple

### 8.8.1 Electrode Placement for 3-lead

Take the American standard for example, see the following figure:

- RA placement - directly below the clavicle and near the right shoulder.
- LA placement: directly below the clavicle and near the left shoulder.
- LL placement - on the left hypogastrium.



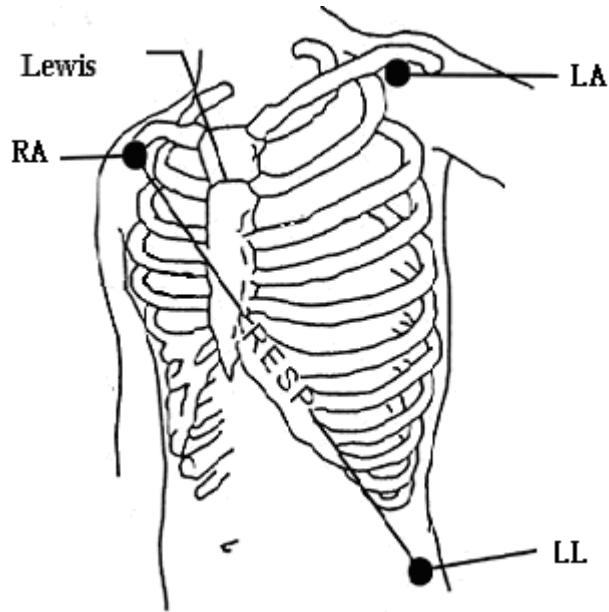

Electrode Placement for 3-lead

## 8.8.2 Electrode Placement for 5-lead

Take the American standard for example, see the following figure:

- RA placement: directly below the clavicle and near the right shoulder.
- LA placement: directly below the clavicle and near the left shoulder.
- RL placement: on the right hypogastrium.
- LL placement: on the left hypogastrium.
- V placement: on the chest, the position depends on your required lead selection.

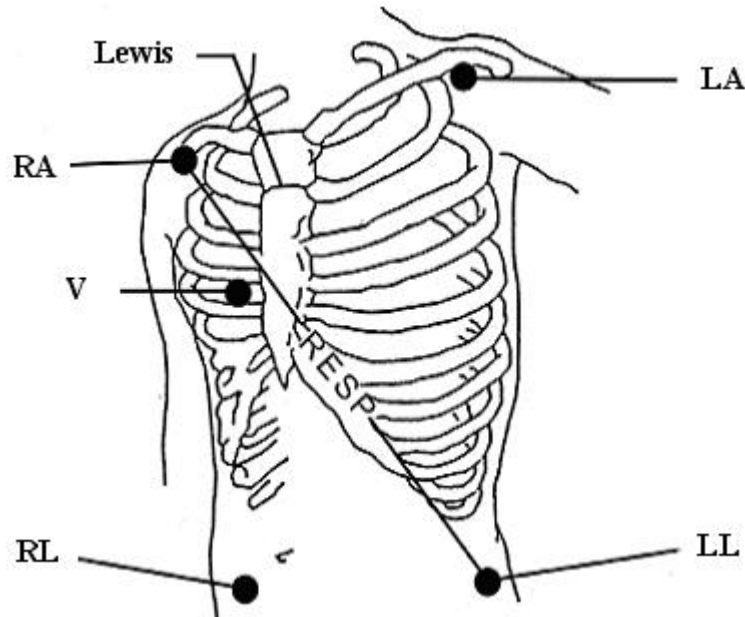

Electrode Placement for 5-lead

### NOTE:

To ensure the patient safety, all leads must be attached to the patient.

For 5-lead, attach the V electrode to one of the indicated positions as below:

- V1            On the 4th intercostal space at the right sterna margin.
- V2            On the 4th intercostal space at the left sterna margin.
- V3            Midway between V2 and V4 electrodes.
- V4            On the 5th intercostal space at the left clavicular line.
- V5            On the left anterior axillary line, horizontal with V4 electrode.
- V6            On the left middle axillary line, horizontal with V4 electrode.
- V3R-V6R    On the right side of the chest in positions corresponding to those on the left.
- VE            Over the xiphoid position.
- V7            On the 5th intercostal space at the left posterior axillary line of back.
- V7R          On the 5th intercostal space at the right posterior axillary line of back.

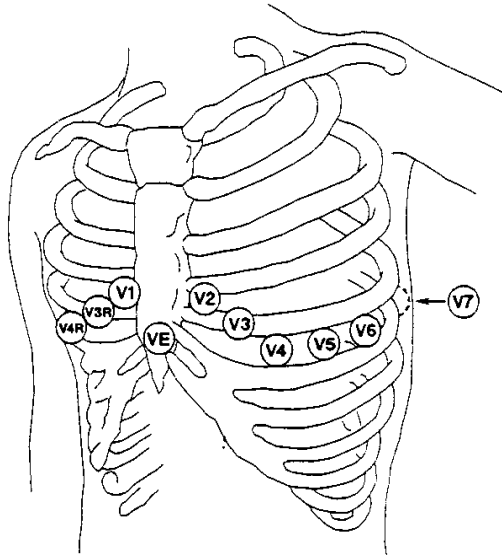

V-Electrode Placement for 5-lead

### 8.8.3 Electrode Placement for 12-lead

Take the American standard for example. The 12-lead electrodes should be placed on extremities and chest. The electrodes for extremities should be placed on the skin of legs or arms, the electrodes placed on chest should follow the doctor's advice. Please see the following figure.

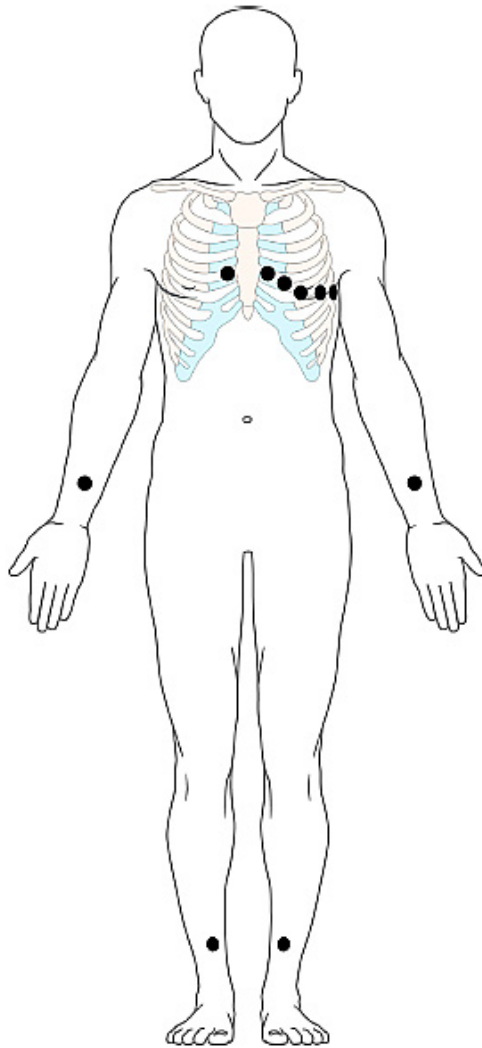

Electrode Placement for 12-lead

#### 8.8.4 Recommended ECG Lead Placement for Surgical Patients

---

**WARNING**

---

When using Electrosurgery (ES) equipment, leads should be placed in a position in equal distance from Electrosurgery electrotome and the ES grounding plate to avoid cautery. Electrosurgery equipment wire and ECG cable must not be tangled up.

---

Monitoring ECG leads are mainly used for monitoring the patient's vital signs. When using the patient monitor with other electrosurgery equipment, it is advised to use the counteracting defibrillation ECG lead.

The placement of the ECG leads will depend on the type of surgery that is being performed. For example, in an open chest surgery the electrodes may be placed laterally on the chest or on the back. In the operating room, artifacts may affect the ECG waveform due to the use of ES (Electrosurgery) equipment. To help reduce this you can place the electrodes on the right and left shoulders, the right and left sides near the abdomen, and the chest lead on the left side at mid-chest. Avoid placing the electrodes on the upper arms. Otherwise the ECG waveform will be too small.

**NOTE:**

- 1 If an ECG waveform is not accurate, while the electrodes are tightly attached, try to change the lead.
- 2 Interference from a non-grounded instrument near the patient and ESU interference can cause inaccuracy of the waveform.

## 8.9 ECG Menu Setup

### 8.9.1 Setting Alarm Source

To change the alarm source, please select **ECG Setup > Alarm Source**, then a pop-up box is displayed:

**HR:** the monitor considers the HR as HR/PR alarm source;

**PR:** the monitor considers the PR as HR/PR alarm source;

**AUTO:** If the Alarm Source is set to **Auto**, the monitor will use the heart rate from the ECG measurement as the alarm source whenever the ECG measurement is switched on and at least one ECG lead can be measured without a technical condition. The monitor will automatically switch to Pulse as the alarm source if:

- a valid ECG lead can no longer be measured and
- a pulse source is switched on and available.

The monitor then uses the pulse rate from the measurement currently active as system pulse. While Pulse is the alarm source, all arrhythmia and ECG HR alarms are switched off. If an ECG lead becomes available again, the monitor automatically uses HR as alarm source.

### 8.9.2 Smart Lead Off

In **5 LEADS**, **12 LEADS** mode, if **CH1** and **CH2** cannot be measured because of the lead off or other reasons, it can shift to other modes to collect an ECG waveform.

To change smart lead off setting, please select **ECG Setup > Smart Leadoff**, then a pop-up menu is displayed.

### 8.9.3 Setting Beat Volume

Beat volume is from HR or PR, depending on your HR alarm setting. Five selections are available: **0, 1, 2, 3, 4, 5**. **5** indicates the maximum volume. **0** indicates the minimum volume.

To change the beat volume, first select **ECG Setup > Beat Volume**, and then select an appropriate volume from the pop-up list.

### 8.9.4 ECG Display

It varies with **Lead Type**. When **Lead Type** is set to **3 Leads**, **Display** can be set to **Normal**, and it can display one ECG waveform on the main screen.

When **Lead Type** is set to **5 Leads**, **Display** can be set to **Normal**, **Full-Scr** and **Half-Scr**. Select **Normal** to display two ECG waveforms on the main screen; select **Full-Scr** to display seven ECG waveforms which occupy the area of seven waveforms on the main screen; Select **Half-Scr** to display seven ECG waveforms on the screen, occupying the area of four waveforms.

**NOTE:**

If **3 Leads** is selected in the **ECG Setup** menu, only **Normal** can be selected for **Display** in the sub-menu.

### 8.9.5 Setting Pace Status

It is important to set the paced status correctly when you start monitoring ECG. To change the paced status in the ECG Setup menu, select **Pace** to toggle between **On** or **Off**. When **Pace** is set to **On**:

- Pace Pulse Rejection is switched on. This means that pacemaker pulses are not counted as extra QRS complexes.
- Paced symbol is displayed as  on the main screen.

**NOTE:**

- 1 When monitoring a patient with a pacemaker, set **Pace** to **On**. If monitoring a patient without a pacemaker, set **Pace** to **Off**.
- 2 If **Pace** is set to **On**, the system will not perform some types of ARR analysis.

---

**WARNING**

---

Some pace pulses can be difficult to reject. When this happens, the pulses are counted as a QRS complex, and could result in an incorrect HR and failure to detect cardiac arrest or some arrhythmias. Keep pacemaker patients under close observation.

---

---

### 8.9.6 ECG Calibration

This item is used to calibrate ECG waveform. When you select this item from ECG Setup menu again, the ECG waveform calibration ends.

**NOTE:**

The device can't be monitored during ECG calibration.

### 8.9.7 ECG Waveform Settings

To change this speed, select **ECG Wave Setup** > **Sweep**, then select an appropriate setting from the pop-up list. The bigger the value is, the wider the waveform is.

### 8.9.8 12 Leads ECG

When the monitor is installed with 12-lead, it can provide 3-lead, 5-lead and 12-lead ECG monitoring functions.

## 8.10 ST Segment Monitoring

The monitor performs ST segment analysis on normal and atrially paced beats and calculates ST segment elevations and depressions. This information can be displayed in the form of ST numeric and snippets on the monitor.

ST segment monitoring function is shut off by default. You can switch it to **On** when necessary. When using the ST analysis function, the ST analysis results will be displayed on the right of the main screen, please refer to the following figure.

### NOTE:

The ST algorithm has been tested for accuracy of the ST segment data. The significance of the ST segment changes need to be determined by a clinician.

### 8.10.1 Setting ST Analysis

To change ST analysis, please select **ECG Setup > ST Analysis**, then select **On** or **Off** from the pop-up list.

### 8.10.2 ST Display

Your monitor screen may be configured to look slightly different from the illustrations.

<b>ST</b>	I	0.08	aVR	-0.09	V	0.04
	II	0.10	aVL	0.03		
	III	0.02	aVF	0.06		

### NOTE:

ST analysis is always performed using a dedicated filter which ensures diagnostic quality. If you are monitoring ECG using an ECG filter mode other than **Diagnosis**, the ST segment of the ECG wave may look different from the ST segment of the ST template for the same wave. For diagnostic evaluation of the ST segment, always set the filter to **Diagnosis** or use the ST template.

### 8.10.3 ST Analysis Alarm Setting

The user can select **ECG Setup > ST Analysis > Alarm Setup** to set the upper alarm limit and lower alarm limit. **ALM HI** can be set to 0.2 mV ~ 2.0 mV, and **ALM LO** can be set to -2.0 mV ~ 0.2 mV. **ALM HI** should be higher than **ALM LO**.

## 8.10.4 About ST Measurement Points

The ST value for each beat complex is the vertical difference between the ISO point and the ST point, as shown in the diagram below. The isoelectric (ISO) point provides the baseline, and the ST point is at the midpoint of the ST segment. The J point is where the QRS complex changes its slope; as it is a fixed distance away from the ST point, it can be useful to help you position the ST point correctly.

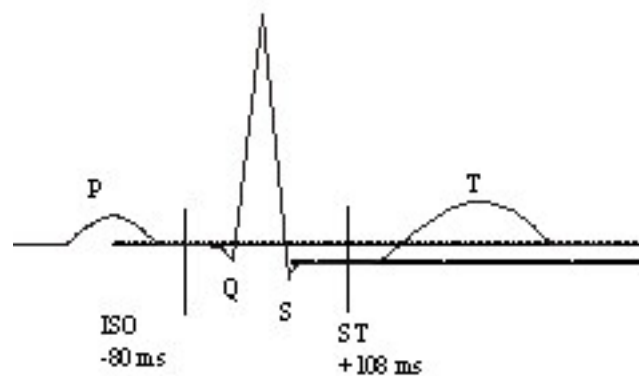

DEF POINT

The ST and ISO measurement points need to be adjusted when you start monitoring, and if the patient's heart rate or ECG morphology changes significantly. Always ensure that ST measurement points are appropriate for your patient. Abnormal QRS complex is not considered in ST segment analysis.

## 8.10.5 Adjusting ST and ISO Measurement Points

Depending on your monitor's configuration, the ST point can be positioned, too.

These two points can be adjusted by turning the knob. When adjusting ST measurement point, the system will show the ST Measurement Point Window. The system displays the QRS complex template in the window. It is adjustable for the highlight bar in the window. You may select ISO or ST, switch the knob left or right to move the cursor line. When the cursor is at the required position, you may select the base point or the measurement point.

## 8.11 Arr. Monitoring

### 8.11.1 Arrhythmia Analysis

The arrhythmia algorithm is used to monitor ECG of patients in clinics, and detect the changes of heart rate and ventricular rhythm, and also save arrhythmia events and generate alarming information. Arrhythmia algorithm can monitor paced and non-paced patients. Qualified personnel can use arrhythmia analysis to evaluate patient's condition (such as heart rate, PVCs frequency, rhythm and ectopic beat) and decide the treatment. Besides detecting change of ECG, arrhythmia algorithm can also monitor patients and give proper alarm for arrhythmia.



The monitor can support up to 16 different arrhythmia analyses.

<b>ARR Types</b>	<b>Occurring Condition</b>
ASYSTOLE	No QRS is detected for 4 consecutive seconds
VFIB/VTAC	Ventricular tachycardia: The RR interval of 4-second fibrillation wave or 5 consecutive ventricular beats is less than 600 ms.
VT>2	3< the number of cluster PVCs < 5
COUPLET	2 consecutive PVCs
BIGEMINY	Vent Bigeminy
TRIGEMINY	Vent Trigeminy
R ON T	A type of single PVC under the condition that HR<100, R-R interval is less than 1/3 the average interval, followed by a compensating pause of 1.25X the average R-R interval (the next R wave advances onto the previous T wave).
PVC	Single PVC detected in normal heartbeats.
TACHY	Adult: 5 consecutive QRS complex, RR interval < 0.5s (HR range: 120~300bpm). Pediatric/neonatal: 5 consecutive QRS complex, RR interval < 0.375s (HR range: 160~350bpm).
BRADY	Adult: 5 consecutive QRS complex, RR interval ≥ 1.5s (HR range: 15~40bpm). Pediatric/neonatal: 5 consecutive QRS complex, RR interval ≥ 1s (HR range: 15~60bpm).
MISSED BEATS	When HR is less than 120 beats/min., no heart beat is tested during the period 1.75 times of the average RR interval; or When HR is ≥ 120 beats/min, no beat is tested within 1 second.
IRR	IRREGULAR RHYTHM: The patient has irregular heart rate.
PNC	PACE NOT CAPTURE: After the pacemaker is paced, QRS complex can not be detected during 300ms.
PNP	PACER NOT PACED: After the QRS complex, no pace is detected during 1.75 times of RR interval.
VBRADY	VENTRICULAR BRADYCARDIA: The interval of 5 consecutive ventricular wave is more than 1000 ms.
VENT	VENTRICULAR RHYTHM: The interval of 5 consecutive ventricular wave ranges from 600 ms to 1000 ms.

## 8.11.2 ARR Analysis Menu

### 8.11.2.1 Switching ARR Analysis On and Off

To switch ARR Analysis on or off, in the **ECG Setup** menu, select **ARR Analysis** to toggle between **On** and **Off** from the popup interface.

### 8.11.2.2 PVCs Alarm

Select **On** in the menu to enable prompt message when an alarm occurs; select **Off** to disable the alarm function, and there will be a symbol  beside **PVCs**.

#### WARNING

When the PVCs Alarm is set to OFF, the monitor won't give an alarm prompt even if an alarm occurs. In order to avoid endangering the patient's life, the user should use this function cautiously.

### 8.11.2.3 ARR Relearning

Pick this item to start a learning procedure, and **ECG ARR LEARNING** is displayed on the screen. The ECG ARR LEARNING will start automatically in the following status:

- Changing lead type;
- Connection leads;
- Updating the patients;
- Starting ARR learning manually;
- After the ARR analysis is switched on;
- The module is set to on;
- Calibration mode is changed to normal measurement mode;
- Exiting the Demo mode;
- Exiting the standby mode;

### 8.11.2.4 ARR Alarm

The users can switch on or off all arrhythmia alarms by selecting **ECG Setup > ARR Analysis > ARR Alarm**. And some arrhythmia alarms can be individually switched on or off. They are: **ASYSTOLE**, **VFIB/VTAC**, **R-ON-T**, **VT>2**, **COUPLET**, **PVC**, **BIGEMINY**, **TRIGEMINY**, **TACHY**, **BRADY**, **MISSED BEATS**, **IRR**, **PNC**, **PNP**, **VBRADY** and **VENT**.

To switch individual alarm on or off, select **ECG Setup > ARR Analysis > ARR Alarm**. The user can set the individual ARR alarm from the popup interface.

## 8.12 12-Lead ECG Monitoring

### 8.12.1 Diagnosis Function

If iM80 is equipped with 12 leads monitoring, the device has automatically diagnosis function. To perform this function, please:

- 1 Set **Lead Type** in the **ECG Setup** menu to **12 Leads** and set **Display** in the **ECG Setup** menu to **12 Leads**.
- 2 Select the **ECG Analysis** shortcut key on the screen.
- 3 The **Diagnosis Review** interface is displayed, shown in figure a. And the diagnosis result is displayed on the interface after approximately 10 seconds, shown in figure b.

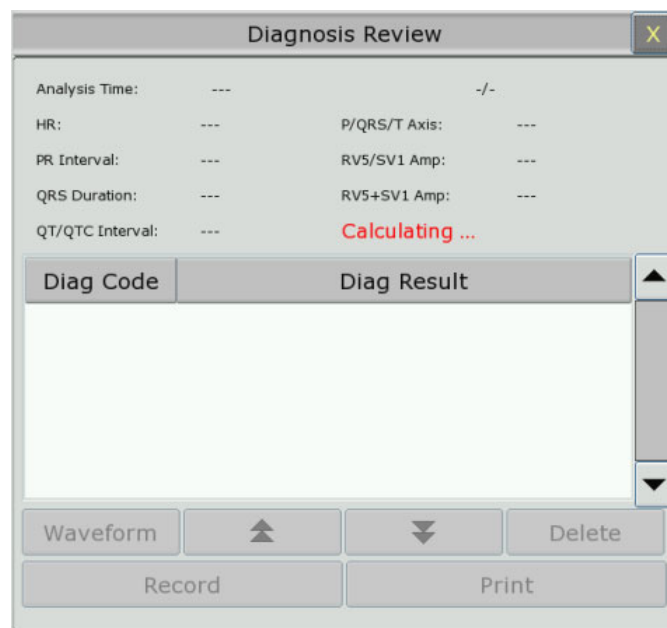

Figure a



Figure b

Figure b shows analysis time, HR (heart rate), P/QRS/T Axis, RR Interval, RVS/SV1 Amp (RVS/SV1 amplitude), QRS Duration, RV5+SV1 Amp (RV5+SV1 amplitude), QT/QTC Interval and Diagnosis code.

More information about diagnosis review, please refer to Section *12-lead Diagnosis Review*.

### 8.12.2 Measurement and Interpretation

The measurement function provides the automatic measurement of these common parameters, such as heart rate, PR interval, QRS complex duration, QT interval, P/QRS/T axis, RV5/SV1 amplitude etc. The interpretation function provides the automatic diagnosis of hundreds of abnormal cases, such as Arrhythmia, AV block, ventricular conduction block, myocardial infarction, ventricular hypertrophy and atria enlargement, ST-T abnormality and electrical axes deviation.

## Chapter 9 Monitoring RESP

### 9.1 Overview

The monitor measures respiration from the amount of thoracic impedance between two ECG electrodes. The change of impedance between the two electrodes, (due to the thoracic movement), produces a respiratory waveform on the screen.

### 9.2 RESP Safety Information

---

**WARNING**

- 1 If you do not set the detection level for the respiration correctly in manual detection mode, it may not be possible for the monitor to detect apnea. If you set the detection level too low, the monitor is more likely to detect cardiac activity, and to falsely interpret cardiac activity as respiratory activity in the case of apnea.
  - 2 The respiration measurement does not recognize obstructive and mixed apneas - it only indicates an alarm when a pre-adjusted time has elapsed since the last detected breath.
  - 3 If operating under conditions according to the EMC Standard EN 60601-1-2 (Radiated Immunity 3V/m), field strengths above 1V/m may cause erroneous measurements at various frequencies. Therefore it is recommended to avoid the use of electrically radiating equipment in close proximity to the respiration measurement unit.
  - 4 Cardiogenic artifact in impedance respiration monitoring may make it difficult to detect breaths or may otherwise be counted as breaths. In some instances, the breath rate may also correspond to the heart rate making it difficult to determine if the signal is due to breathing or the cardiac cycle. Do not rely on RESP monitoring as the sole method for detecting cessation of breathing. Follow hospital guidelines and best clinical practices for apnea detection including monitoring additional parameters that indicate the patient's oxygenation status, such as etCO<sub>2</sub> and SpO<sub>2</sub>.
- 

**NOTE:**

The RESP monitoring is not recommended to be used on patients who are very active, as this can cause false alarms.

## 9.3 Resp Display

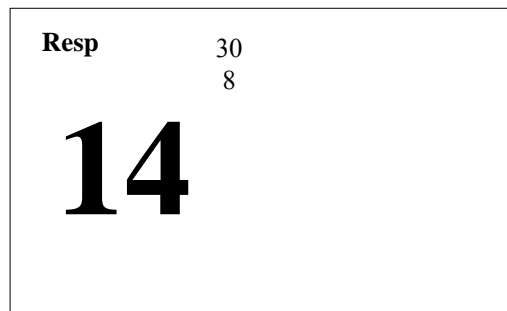

## 9.4 Electrode Placement for Monitoring Resp

Correct patient skin preparation techniques for electrode placement are important for Resp measurement: you will find this information in the chapter on *Monitoring ECG*.

The Resp signal is always measured between two of the ECG electrodes. There are two standard ECG leads for selection: I lead (RA and LA) and II lead (RA and LL).

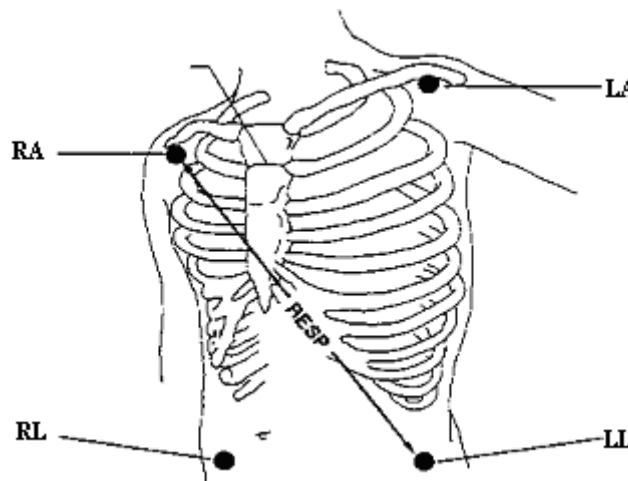

Electrodes Placement for 5-lead

## 9.5 Cardiac Overlay

Cardiac activity that affects the Resp waveform is called cardiac overlay. It happens when the Resp electrodes pick up impedance changes caused by the rhythmic blood flow. Correct electrode placement can help to reduce cardiac overlay: avoid the liver area and the ventricles of the heart in the line between the respiratory electrodes. This is particularly important for neonates.

## 9.6 Chest Expansion

Some patients, especially neonates, expand their chests laterally. In these cases it is best to place the two respiratory electrodes in the right mid-axillary and left lateral chest areas at the patient's maximum point of breathing movement to optimize the respiratory wave.

## 9.7 Abdominal Breathing

Some patients with restricted chest movement breathe mainly abdominally. In these cases, you may need to place the left leg electrode on the left abdomen at the point of maximum abdominal expansion to optimize the respiratory wave.

### NOTE:

Place the red and green electrodes diagonally to optimize the respiration waveform. Avoid the liver area and the ventricles of the heart in the line between the RESP electrodes so as to avoid cardiac overlay or artifacts from pulsating blood flow. This is particularly important for neonates.

## 9.8 Selecting Resp Lead

To change Resp lead, in the **Resp Setup** menu, select **Resp Lead** to pick up the appropriate lead from the pop-up list.

## 9.9 Changing Hold Type

To change the calculation mode, in the **Resp Setup** menu, set **Hold Type** to **Manual** or **Auto**. When it is set to the **AUTO** mode, **Hold High** and **Hold Low** are unavailable, and the monitor can calculate the respiration rate automatically. When it is set to the **Manual** mode, you can adjust the broken lines in RESP area by the **Hold High** and **Hold Low** items.

## 9.10 Changing the Size of the Respiration Wave

Select the Resp waveform area to open the **Resp Wave Setup** menu:

- Select **AMP**, then choose an appropriate value. The value is bigger, the waveform amplitude is higher.
- Select **Sweep**: select an appropriate setting from the pop-up list.

## 9.11 Using Resp Alarms

Resp alarms can be switched on and off and the high and low alarm limits can be changed just like other measurement alarms, as described in the Alarms chapter.

## 9.12 Changing the Apnea Time

The apnea alarm is a high priority red alarm used to detect apneas. The apnea alarm delay time defines the time period between the point where the monitor cannot detect any respiration activity and the indication of the apnea alarm.

1. In the **Resp Setup** menu, select **Apnea Alm**.
2. Select the appropriate setting from the popup list.

## Chapter 10 Monitoring SpO<sub>2</sub>

### 10.1 Overview

SpO<sub>2</sub> is based on the absorption of pulse blood oxygen to red and infrared light by means of finger sensor and SpO<sub>2</sub> measuring unit. SpO<sub>2</sub> Plethysmogram measurement is employed to determine the oxygen saturation of hemoglobin in the arterial blood. If, for example, 97% of the hemoglobin molecules in the red blood cells of the arterial blood combine with oxygen, then the blood has a SpO<sub>2</sub> oxygen saturation of 97%. The SpO<sub>2</sub> numeric on the monitor will read 97%. The SpO<sub>2</sub> numeric shows the percentage of hemoglobin molecules which have combined with oxygen molecules to form oxyhemoglobin. The SpO<sub>2</sub>/PLETH parameter can also provide a pulse rate signal and a plethysmogram wave.

### 10.2 SpO<sub>2</sub> Safety Information

---

**WARNING**

---

- 1 If the SpO<sub>2</sub> sensor cannot work properly, please reconnect the sensor or change a new one.
  - 2 Do not use the sterile supplied SpO<sub>2</sub> sensors if the packaging or the sensor is damaged and return them to the vendor.
  - 3 Prolonged and continuous monitoring may increase the risk of unexpected change of dermal condition such as abnormal sensitivity, rubescence, vesicle, repressive putrescence, and so on. It is especially important to check the sensor placement of neonate and patient of poor perfusion or immature dermogram by light collimation and proper attaching strictly according to changes of the skin. More frequent examinations may be required for different patients.
  - 4 Tissue damage may be caused by incorrect application or prolonged measurement duration using the sensor (more than 4 hours). Inspect the sensor periodically according to the sensor user manual.
  - 5 Use only EDAN permitted sensors and extension cables with the monitor. Other sensors or extension cables may cause improper monitor performance and/or minor personal injury.
- 

**NOTE:**

- 1 Make sure the nail covers the light window. The wire should be on the backside of the hand.
- 2 SpO<sub>2</sub> waveform is not proportional to the pulse volume.
- 3 Avoid placing the sensor on extremities with an arterial catheter, or intravascular venous infusion line.



- 4 Don't use the functional tester to access the SpO<sub>2</sub> accuracy.
- 5 The device is calibrated to display functional oxygen saturation.
- 6 The materials with which the patient or any other person can come into contact conform with the standard of EN ISO 10993-1:2003.

### 10.3 Measuring SpO<sub>2</sub>

1. Select the correct patient category setting (adult/pediatric and neonatal), as this is used to optimize the calculation of the SpO<sub>2</sub> and pulse numeric.
2. During measurement, ensure that the application site:
  - has a pulsatile flow, ideally with a good circulation perfusion.
  - has not changed in its thickness, causing an improper fit of the sensor.

### 10.4 Measurement Procedure

1. Switch on the monitor.
2. Attach the sensor to the appropriate site of the patient finger.
3. Plug the connector of the sensor extension cable into the SpO<sub>2</sub> socket on the SpO<sub>2</sub> module.

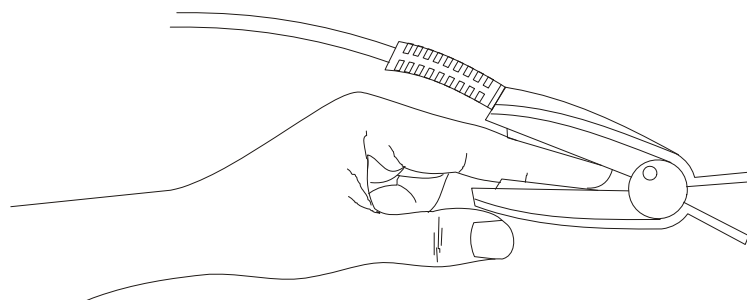

Mounting of the Sensor

---

#### **WARNING**

Inspect the application site every two to three hours to ensure skin quality and correct optical alignment. If the skin quality changes, move the sensor to another site. Change the application site at least every four hours.

---

#### **NOTE:**

Injected dyes such as methylene blue or intravascular dyshemoglobins such as methemoglobin and carboxyhemoglobin may lead to inaccurate measurements.

Interference can be caused by:

- High levels of ambient light or strobe lights or flashing lights (such as fire alarm lamps). (Hint: cover application site with opaque material.)
- High-frequency electrical noise, including electro-surgical apparatus and defibrillators

- Intravascular dye injections
- Significant concentrations of dysfunctional hemoglobin, such as carboxyhemoglobin and methemoglobin
- Excessive patient movement and vibration
- Improper sensor application
- Low perfusion or high signal attenuation
- Venous pulsation
- Placement of the sensor on an extremity that has a blood pressure cuff, arterial catheter, or intravascular line

## 10.5 Understanding SpO<sub>2</sub> Alarms

This refers to SpO<sub>2</sub> specific alarms. See the Alarms section for general alarm information. SpO<sub>2</sub> offers high and low limit alarms, and the users can adjust them.

## 10.6 Adjusting Alarm Limits

In the **SpO<sub>2</sub> Setup** menu, select **Alarm Setup**:

- Set the SpO<sub>2</sub> High Alarm Limit to an appropriate value from the popup interface.
- Set the SpO<sub>2</sub> Low Alarm Limit to an appropriate value from the popup interface.

---

### WARNING

---

High oxygen levels may predispose a premature infant to retrolental fibroplasia. If this is a consideration do NOT set the high alarm limit to 100%, which is equivalent to switching the alarm off.

---

## 10.7 Setting SpO<sub>2</sub> as Pulse Source

1. In the **PR Setup** menu, select **PR Source**;
2. Select **SpO<sub>2</sub>** from the pop-up list.

## 10.8 Setting Pitch Tone

If tone modulation is on, the PR sound lowers when the SpO<sub>2</sub> level drops. In the **SpO<sub>2</sub> Setup** menu, select pitch tone to toggle between **On** and **Off**.

## 10.9 Setting Sensitivity

The different sensitivity indicates different refresh frequency. **High** indicates the refresh frequency of SpO<sub>2</sub> value is the most frequent. To change the sensitivity, please follow the steps:

- 1 Select the **SpO<sub>2</sub> Setup** menu;
- 2 Select **Sensitivity** on the interface and select the desired sensitivity from the popup list.

## Chapter 11 Monitoring PR

### 11.1 Overview

The pulse numeric counts the arterial pulsations that result from the mechanical activity of the heart in beats per minute (bpm). You can display a pulse from any measured SpO<sub>2</sub> signal or any arterial pressure.

### 11.2 Setting PR Source

The monitor provides PR source options. You can select SpO<sub>2</sub> or arterial pressure labels as the PR source in the **PR Source** list on the **PR Setup** menu.

**NOTE:**

In the **PR Source** list, an arterial pressure label accompanied with a label with brackets indicates this label is in conflict. Do not select a conflicting label as the PR source.

### 11.3 Setting PR Volume

Six selections are available: **0**, **1**, **2**, **3**, **4**, and **5**. **5** indicates the maximum volume. **0** indicates no sound. You can change **PR Volume** in the **PR Setup** menu.

### 11.4 Using Pulse Alarms

You can change pulse rate alarm limits in the **PR Setup** menu by selecting **Alarm Setup**. Pulse alarms are only generated when the active alarm source is set to **PR**, a pulse source is set as system pulse and pulse alarms are switched on.

### 11.5 Selecting the Active Alarm Source

In most cases, the HR and Pulse numerics are identical. In order to avoid simultaneous alarms on HR and Pulse, the monitor uses either HR or Pulse as its active alarm source. To change the alarm source, select Alarm Source in the HR/Pulse Alarms menu, then select

- **HR**: if you want HR to be the alarm source for HR/Pulse.
- **PR**: if you select Pulse as the active alarm source, the monitor will prompt you to confirm your choice. Be aware that if you select Pulse as the alarm source, all arrhythmia and ECG HR alarms are switched off.
- **AUTO**: if the Alarm Source is set to Auto, the monitor will use the heart rate from the ECG measurement as the alarm source whenever the ECG measurement is switched on and at least one ECG lead can be measured without a technical alarm condition. The monitor will automatically switch to Pulse as the alarm source.

## Chapter 12 Monitoring NIBP

### 12.1 Overview

This monitor uses the oscillometric method for measuring NIBP. It can be used for adult, pediatric and neonatal patients.

Oscillometric devices measure the amplitude of pressure changes in the occluding cuff as the cuff deflates from above systolic pressure. The amplitude suddenly increases as the pulse breaks through the occlusion in the artery. As the cuff pressure decreases further, the pulsations increase in amplitude, reach a maximum (which approximates to the mean pressure), and then diminish.

In adult and pediatric mode, the blood pressure measurements determined with this device comply with the American National Standard for Electronic or Automated Sphygmomanometers (ANSI/AAMI SP10-1992) in relation to mean error and standard deviation, when compared to auscultatory measurements in a representative patient population. For the auscultatory reference, the fifth Korotkoff sound was used to determine the diastolic pressure.

In neonatal mode, the blood pressure measurements determined with this device comply with the American National Standard for Electronic or Automated Sphygmomanometers (ANSI/AAMI SP10-1992) in relation to mean error and standard deviation, when compared to intra-arterial measurements in a representative patient population.

### 12.2 NIBP Safety Information

---

**WARNING**

- 1 Do not measure NIBP on patients with sickle-cell disease or any condition where skin damage has occurred or is expected.
  - 2 Use clinical judgement to decide whether to perform frequent unattended blood pressure measurements on patients with severe blood clotting disorders because of the risk of hematoma in the limb fitted with the cuff.
  - 3 Ensure that the correct setting is selected when performing measurements. It may be dangerous for the children to use an over pressure level.
  - 4 The equipment is suitable for use in the presence of electrosurgery.
  - 5 The equipment can provide protective means to prevent the patient from being burned when used with HF SURGICAL EQUIPMENT. The equipment can protect against the effects of the discharge of a defibrillator.
  - 6 Before starting a measurement, verify that you have selected the proper Patient Info->Type for the patient (adult, pediatric or neonatal.) A wrong type selection may cause inaccurate measurement results or serious injuries.
-

---

---

**WARNING**

---

---

- 7 Do not apply the cuff to a limb that has an intravenous infusion or catheter in place. This could cause tissue damage around the catheter when infusion is slowed or blocked during cuff inflation.
  - 8 Make sure that the air conduit connecting the blood pressure cuff and the monitor is neither blocked nor tangled.
  - 9 Do not attach the cuff to a limb being used for IV infusions as the cuff inflation can block the infusion, potentially causing harm to patient.
- 
- 

**NOTE:**

- 1 It is suggested that the user should not start NIBP measuring when the low battery displays, or the monitor may be turned off automatically.
- 2 If you spill liquid onto the equipment or accessories, particularly if there is a chance that it can get inside the tubing or the measurement device, contact your service personnel.
- 3 Continuous use of the automatic measuring mode for short intervals may lead to the discomfort of patient.

## 12.3 Introducing the Oscillometric NIBP Measurement

Oscillometric devices measure the amplitude of pressure changes in the occluding cuff as the cuff deflates from above systolic pressure. The amplitude suddenly increases as the pulse breaks through the occlusion in the artery. As the cuff pressure decreases further, the pulsations increase in amplitude, reach a maximum (which approximates to the mean pressure), and then diminish.

## 12.4 Measurement Limitations

Measurements are impossible with heart rate extremes of less than 40 bpm or greater than 240 bpm, or if the patient is on a heart-lung machine.

The measurement may be inaccurate or impossible in the following situations:

- A regular arterial pressure pulse is hard to detect.
- Patients with cardiac arrhythmias.
- Patients with excessive and continuous movement such as shivering or convulsions.
- Patients with rapid blood pressure changes.
- Patients with severe shock or hypothermia that reduces blood flow to the peripheries.
- Patients with obesity, where a thick layer of fat surrounding a limb dampens the oscillations coming from the artery.
- Patients on an edematous extremity.

## 12.5 Measurement Methods

There are three methods of measuring NIBP:

- Manual - measurement on demand.
- Auto - continually repeated measurements (between 1 and 480 minute adjustable interval).
- Sequence - the measurement will run consecutively in five minutes, then the monitor enters manual mode.

---

---

### WARNING

Prolonged non-invasive blood pressure measurements in Auto mode may be associated with purport, ischemia and neuropathy in the limb wearing the cuff. When monitoring a patient, examine the extremities of the limb frequently for normal color, warmth and sensitivity. If any abnormality is observed, stop the blood pressure measurements.

---

---

## 12.6 Measurement Procedures

1. Connect the air hose and switch on the monitor.
2. Apply the blood pressure cuff to the patient's arm or leg and follow the instructions below. Ensure that the cuff is completely deflated.

Apply the appropriate size cuff to the patient (About the cuff size selection, please refer to Section *NIBP accessories*), and make sure that the symbol "Φ" is over the artery. Ensure that the cuff is not wrapped too tightly around the limb. Excessive tightness may cause discoloration and eventual ischemia of the extremity.

### NOTE:

The width of the cuff should be either approximately 40% of the limb circumference (50% for neonates) or 2/3 of the upper arm length. The inflatable part of the cuff should be long enough to encircle 50-80% of the limb. The wrong size of cuff can cause erroneous readings. If the cuff size is in question, use a larger cuff.

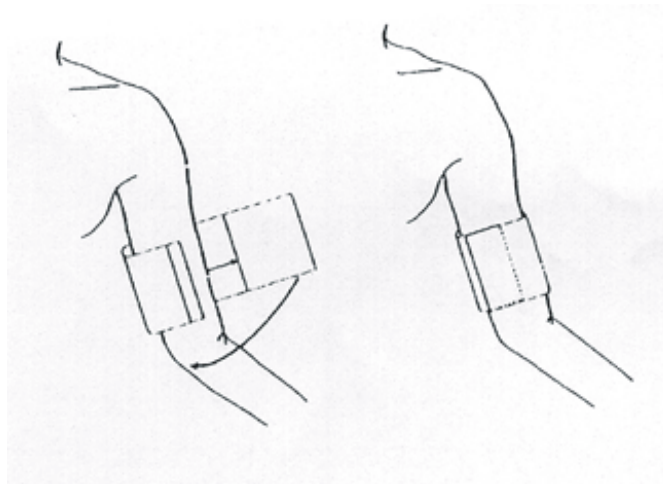



Cuff Usage

3. Connect the cuff to the air tubing.
4. Check whether the patient mode is appropriately selected. Access the **Patient Setup** menu from **Menu**. Turn the knob to select the required patient **Type** in the **Patient Info.** menu.
5. Select a measurement mode in the **NIBP Setup** menu. Refer to section **Operation Prompts** for details.
6. Press the  button on the front panel to start a measurement.

## 12.7 Operation Prompts

### 1. Manual Measuring

Access the **NIBP Setup** menu and set the **Measure Mode** item to **Manual**. Then press the  button on the front panel to start a manual measurement.

During the idle period of measurement process, press the  button on the front panel at any time to start a manual measurement. Then press the  button on the front panel to stop manual measurement and the system continues to execute auto measurement program according to the selected time interval.

### 2. Automatical Measurement

Access the **NIBP Setup** menu and set the **Measure Mode** item to **Auto**, then press the  button on the front panel to start the automatical measurement according to the selected time interval.

### 3. Continuous measurement

Access the **NIBP Setup** menu and pick the **Continual** item to start a continuous measurement. The continuous measurement will last 5 minutes.

### 4. Stopping continuous measurement

During continuous measurement, press the  button on the front panel at any time to stop continuous measurement.

## 12.8 Correcting the Measurement if Limb is not at Heart Level

To correct the measurement if the limb is not at heart level to the displayed value:

Add 0.75mmHg (0.10kPa) for each centimeter higher or	Deduct 0.75mmHg (0.10kPa) for each centimeter lower or
Add 1.9mmHg (0.25kPa) for each inch higher	Deduct 1.9mmHg (0.25kPa) for each inch lower



## 12.9 NIBP Alarm

When **NIBP Alarm** is set to **On**, the physiology alarm occurs if any measurement value of Systolic pressure, Mean pressure, Diastolic pressure exceeds alarm limit. The users can adjust the alarm limit by accessing **NIBP Setup > Alarm Setup > Sys Alarm/Map Alarm/Dia Alarm**.

## 12.10 Resetting NIBP

When the pressure does not work properly and the system fails to give a message for the problem, pick **Reset** in the **User Maintain > NIBP Maintain** menu to activate self-test procedure, and thus restore the system from abnormal performance.

## 12.11 Calibrating NIBP

NIBP is not user-calibrated. Cuff-pressure transducers must be verified and calibrated on a yearly interval by a qualified service professional. See the Service Manual for details.

## 12.12 Leak Test

This item is used for leak test. Turn the knob to pick the **Leak Test** item in the **User Maintain > NIBP Maintain** menu to start the air leakage test. When the item is selected, it will change into **Stop**. If this item is selected again, the system will stop air leakage test. And the item returns to **Leak Test**.

---

### WARNING

---

This pneumatic test other than being specified in the EN 1060-1 standard is to be used by the user to simply determine whether there are air leaks in the NIBP airway. If at the end of the test the system gives the prompt that the NIBP airway has air leaks, please contact the manufacturer for repair.

---

### 12.12.1 Procedure of Leak Test

- Connect the cuff securely with the socket for NIBP air hole.
- Wrap the cuff around the cylinder of an appropriate size.
- Access **User Maintain > NIBP Maintain**.
- Turn the knob to the **Leak Test** item and press the item. Then the prompt of **Leak Testing** will appear indicating that the system has started performing leak test.

For iM70/iM80 with the Omron module:

The system will automatically inflate the pneumatic system to about 180 mmHg (285mmHg for Omron Module). After 20 seconds (4 minutes for Omron Module), the system will automatically open the deflating valve, which marks the completion of a pneumatic measurement.

For iM50/iM60/iM70 with the EDAN module:

The system will automatically inflate the pneumatic system to about 180 mmHg. After 20 seconds, the system will automatically open the deflating valve, which marks the completion of a pneumatic measurement.

For iM80 with the EDAN module:

The system will automatically inflate the pneumatic system to about 180mmHg. After 20 to 40 seconds, if system leakage has detected, the system will automatically open the deflating valve to stop the leak test and indicates **NIBP Leak**. If no system leakage is detected when the pneumatic system is inflated to 180mmHg, the system will perform a deflation to an approximate value of 40mmHg and subsequently perform the second phase leak test. After 20 to 40 seconds, the system will automatically open the deflating valve and provide corresponding indication based on the test result.

- If the alarm information of **NIBP Leak** appears, it indicates that the airway may have air leaks. In this case, the user should check for loose connection. After confirming secure connections, the user should re-perform the pneumatic test. If the failure prompt still appears, please contact the manufacturer for repair.

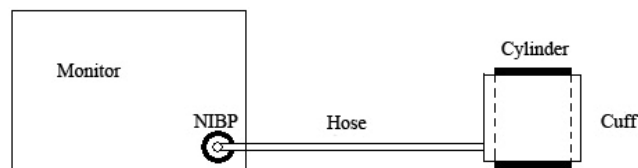

Diagram of NIBP Air Leakage Test

## Chapter 13 Monitoring TEMP

### 13.1 Overview

Body temperature is measured by means of a thermistor probe (a semiconductor whose resistance changes with temperature) that is applied to the skin or to the rectum.

Two TEMP probes can be used simultaneously to measure two TEMP values and get the temperature difference. The standard configuration is skin probe for adult.

### 13.2 TEMP Safety Information

---

#### WARNING

- 1 Verify probe cables fault detection before the beginning of monitoring phase. Unplug the temperature probe cable of the channel from the socket, and then the screen will display the error message **TEMP T1 Sensor Off** and the auditory alarm is activated. It is the same to the other channel.
  - 2 Take the TEMP probe and cable carefully. When they are not in use, you should coil up the probe and cable into a loose circle. If the wire inside the cable is tensely pulled, it may cause mechanical damage to the probe and the cable.
- 

### 13.3 TEMP Monitoring Setup

With a reusable TEMP probe you can plug the probe directly into the monitor. Apply the TEMP probes securely to the patient. Switch on the monitor.

It takes 2 min ~ 3 min for the body temperature to stabilize.

### 13.4 Calculating Temp Difference

The monitor can calculate and display the difference between two temperature values by subtracting T2 from T1. The difference is labeled TD.

## Chapter 14 Monitoring Quick TEMP\*

\*not available in the U.S.A., Canada, UK and Germany

### 14.1 Overview

Quick temperature measurement is to establish thermal balance between probe and human body. When the probe is placed on the measurement site until a steady reading is available - after approximately three minutes for oral and rectal measurements and five minutes for axillary measurements. And the measurement temperature is the monitoring temperature. The temperature curve in this process has a certain discipline. The approximately actual temperature curve can be simulated by temperature data sampled earlier. The temperature at thermal balance is calculated through the specific algorithm based on the curve.

The monitor can only measure temperature of adult and pediatric patients. If the user measures temperature of neonatal patient, the monitor will not display data. The oral/axillary sensor and rectal sensor are of standard configuration.

### 14.2 Quick TEMP Safety Information

---

**WARNING**

- 1 To ensure optimal accuracy, always confirm that the correct mode and alarm limit are selected. Changing the measure position may lead to the change of alarm limit.
  - 2 Verify probe cables fault detection before the beginning of monitoring phase. Unplug the temperature probe cable from the socket, and then the screen will display the error message TEMP SENSOR OFF and the auditory alarm is activated.
  - 3 Take the TEMP probe and cable carefully. When they are not in use, you should coil up the probe and cable into a loose circle. If the wire inside the cable is tensely pulled, it may cause mechanical damage to the probe and the cable.
  - 4 The calibration of the temperature module is necessary every two years (or as frequently as dictated by your Hospital Procedures Policy). When you need to calibrate the temperature measurement, please contact the manufacturer.
  - 5 Patient actions may interfere with accurate oral temperature readings. Ingesting hot or cold liquids, eating food, chewing gum or mints, brushing teeth, smoking or performing strenuous activity may affect temperature readings for up to 20min after activity has ended.
  - 6 Do not take an axillary temperature through patient's clothing. Direct probe cover to skin contact is required.
  - 7 Biting the sensor tip while taking a temperature may result in damage to the sensor.
-

---

**WARNING**

---

- 8 Make sure disposable TEMP sensor covers are used to limit patient cross-contamination. The use of any other probe cover may produce temperature measurement errors or result in inaccurate readings.
  - 9 Quick Temp measurement isn't suitable for use during defibrillation.
- 

## 14.3 Measuring Procedure

### 14.3.1 Measurement for Oral Temperature

1. Ensure the oral probe (white probe) and probe well are installed.
2. Remove the probe from the probe well.
3. Observe the oral mode indicator on the screen (flashing head icon).

If this icon is not flashing, press the **Measure Pos** button and set it to **Oral** until the head icon appears.

4. Load the probe cover.
5. Place the probe tip deep into the patient's sublingual pocket as shown in the following figure.

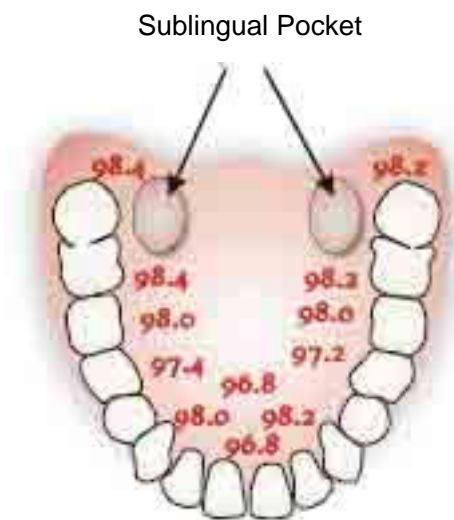

Measuring Position in Mouth

6. Do not hand the probe to the patient to place in his or her own mouth.
7. Always hold the probe in place, maintaining tissue contact until temperature is complete.

If necessary, repeat the measurement procedure shown above.

**NOTE:**

- 1 After one measurement, the user should put the sensor well to the sensor bracket and then take it out for starting a new measurement.
- 2 To ensure optimal accuracy, always confirm that the correct measurement position is selected.

### 14.3.2 Measurements for Rectal Temperatures

1. Ensure that the rectal probe (red probe) and probe well are installed.
2. Remove the red probe from the probe well.
3. Observe the Rectal Mode indicator on the display (flashing lower body icon).
4. Load a probe cover. Apply lubricant if desired.
5. Separate the buttocks and gently insert the probe only 1.5cm (5/8 inch), less for infants and children.

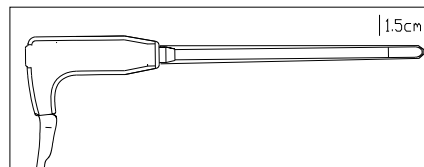

Measuring Position in Rectal

---

**WARNING**

Incorrect insertion can cause bowel perforation.

---

### 14.3.3 Measurements for Axillary Temperatures

1. Ensure that the white probe and probe well are installed.
2. Remove the probe from the probe well.
3. Press **Quick TEMP Setup > Measure Pos** and select the Axillary mode.
4. Observe the axillary mode indicator on the display (flashing axillary icon).
5. Load a probe cover.
6. Adjust clothing to visualize the axilla.
7. Avoid folds in the axilla and place the probe tip vertically as high as you can as shown.
8. Place the arm at the patient's side. Hold in this position without movement of the arm or probe during the measurement cycle.

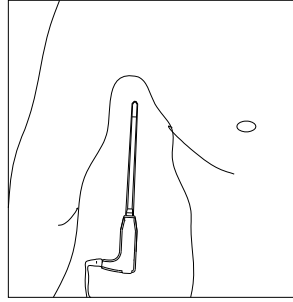

Measuring Position in Axillary

**NOTE:**

Do not take an axillary temperature through the patient's clothing. Direct contact between the patient's skin and the probe is required.

To obtain accurate rectal temperature, use the white temperature probe.

## 14.4 Changing Temp Unit

To change **Temp Unit**, please:

- 1 Select the **Quick Temp Setup** menu to open it and select **Unit** on the interface.
- 2 Select the appropriate unit from the popup list.

## Chapter 15 Monitoring IBP

### 15.1 Overview

IBP is measured by means of a catheter inserted directly into the circulatory system. A pressure transducer connected to the catheter converts the mechanical force exerted by the blood into an electrical signal, which is displayed graphically as pressure versus time on a monitor screen or numerically on digital display.

The monitor measures direct blood pressure of one selected blood vessel through two channels or four channels, and displays waveforms and pressure of measured direct blood pressure (SYS, DIA and MAP).

### 15.2 IBP Safety Information

---

---

**WARNING**

- 1 The operator should avoid contact with the conductive parts of the appurtenance when it is connected or applied.
  - 2 When the monitor is used with HF surgical equipment, the transducer and the cables must be avoided from conductive connection to the HF equipment. This is to protect against burns to the patient.
  - 3 Disposable IBP transducer or domes should not be reused.
  - 4 If any kind of liquid, other than solution to be infused in pressure line or transducer, is splashed on the equipment or its accessories, or enters the transducer or the monitor, contact the Hospital Service Center immediately.
- 
- 

**NOTE:**

- 1 Use only the pressure transducer listed in the IBP Accessories
- 2 Calibrate the instrument either whenever a new transducer is used, or as frequently as dictated by your Hospital Procedures Policy.

### 15.3 Monitoring Procedures

Preparatory steps for IBP measurement:

- 1 Plug the pressure cable into the corresponding socket and switch on the monitor.
- 2 Flushing through the system with normal saline solution. Ensure that the system is free of air bubbles.
- 3 Connect the patient catheter to the pressure line, making sure that there is no air present in the catheter or pressure line.



4. Position the transducer so that it is at the same level with the patient's heart, approximately mid-axillary line.
5. For the label name selection, please refer to Selecting a Pressure for Monitoring.
6. To zero the transducer, please refer to Zeroing the Pressure Transducer.

---



---

### **WARNING**

If there are air bubbles in the pressure line or the transducer, you should flush the system with the solution to be infused.

---



---

## 15.4 Selecting a Pressure for Monitoring

Tell the monitor which pressure you want to monitor by selecting its pressure label. The label is a unique identifier for each type of pressure. When you choose a label, the monitor uses that label's stored settings, for example color, wave scale and alarm settings. The label also determines which algorithm is used to process the pressure signal, so an incorrect label can lead to incorrect pressure values. To select the label, please refer to the following table:

Label	Description
ART	Arterial blood pressure
PA	Pulmonary artery pressure
CVP	Central venous pressure
ICP	Intracranial pressure
LAP	Left atrial pressure
RAP	Right atrial pressure
P1-P2	Alternative non-specific pressure labels

## 15.5 Zeroing the Pressure Transducer

To avoid inaccurate pressure readings, the monitor requires a valid zero. Zero the transducer in accordance with your hospital policy (at least once per day). You must perform a zero:

- When you use a new transducer or tubing
- Every time you reconnect the transducer cable to the monitor;
- If you think the monitor's pressure readings are not correct.

When using a pressure module, the zero information is stored in the module.

## 15.6 Zeroing a Pressure Measurement

The zeroing procedure is listed as below:

1. Turn off the stopcock to the patient.
2. Vent the transducer to atmospheric pressure, to compensate for the static and atmospheric pressure exerted on the transducer.
3. In the setup menu for the pressure, select **Zero**.
4. When you see the message **Zero Ok**, please close the stopcock to atmospheric pressure, and open the stopcock to the patient.

## 15.7 Troubleshooting the Pressure Zeroing (Taking Art for Example)

The status message lists the probable cause of an unsuccessful calibration.

Message	Corrective Action
Art ZERO FAIL	Make sure that the transducer is not attached to the patient
Art SENSOR OFF, FAIL	Make sure that transducer is not off, and then proceed zeroing
IN DEMO, FAIL	Make sure that the monitor is not in DEMO mode. Contact service technician if necessary
PRESSURE OVER RANGE, FAIL	Make sure that the stopcock is vented to atmosphere. If the problem persists, please contact service technician
PULSATILE PRESSURE ZERO FAIL	Make sure that the transducer is vented to air, not connected to a patient, and try again.

## 15.8 IBP Pressure Calibration

1. Mercury calibration should be performed by the biomedical engineering department either whenever a new transducer is used, or as frequently as dictated by your Hospital Procedures Policy.
2. The purpose of the calibration is to ensure that the system gives you accurate measurements.
3. Before starting a mercury calibration, a zero procedure must be performed.

If you need to perform this procedure yourself, you will need the following equipment: Standard sphygmomanometer, 3-way stopcock and Tubing (approximately 25 cm long).

The calibration procedure is listed below:

1. Close the stopcock that was open to atmospheric pressure for the zero calibration.
2. Attach the tubing to the sphygmomanometer.

3. Ensure that connection to patient is off.
4. Connect the 3-way connector to the 3-way stopcock that is not connected to the patient catheter.
5. Open the port of the 3-way stopcock to the sphygmomanometer.
6. Select the channel to be calibrated in the menu and select the pressure value to which the IBP is to be adjusted.
7. Inflate to make the mercury bar rise to the setup pressure value.
8. Adjust repeatedly until the value in the menu is equal to the pressure value shown by the mercury calibration.
9. Press the Start button, the device will begin calibrating.
10. Wait for the calibrated result. You should take corresponding measures based on the prompt information.
11. After calibration, disassemble the blood pressure tubing and the attached 3-way valve.

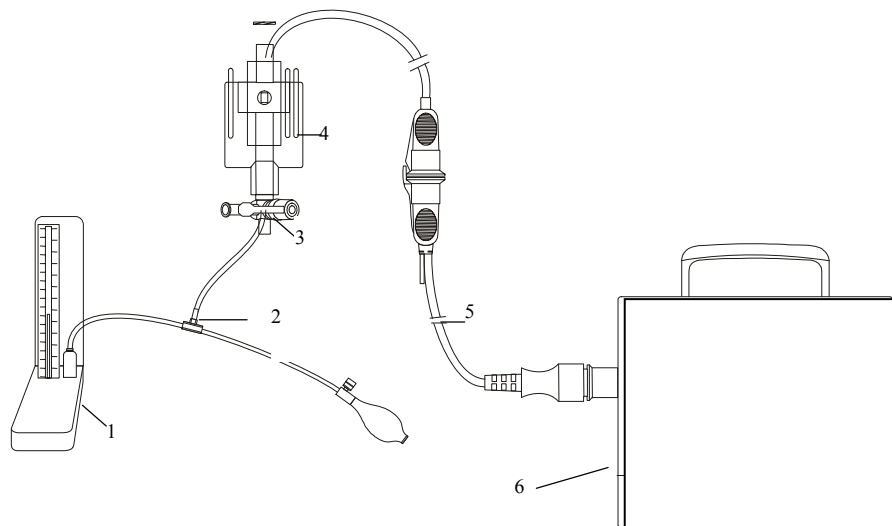

1: Hydrargyrum pressure meter; 2: 3-way connector; 3: 3-way stopcock; 4: Pressure transducer; 5: Pressure transducer interface cable; 6: Monitor

#### IBP Calibration

## 15.9 Troubleshooting the Pressure Calibration

The status line lists the probable reasons of an unsuccessful calibration.

Causes	Corrective Action
Sensor Off, Fail!	Make sure that sensor is not off, and then start the calibration. Contact service technician if necessary.
Unable to calibrate in Demo Mode.	Make sure that the monitor is not in DEMO mode. Contact service technician if necessary.

Pressure out of normal range, fail.	Make sure that you have selected transducer value in IBP CAL, and then start the calibration. Contact service technician if necessary.
Pulsate Pressure Calibration Fail	Make sure that pressure value shown by hydrargyrum pressure meter is changeless. Contact service technician if necessary.

## 15.10 IBP Alarm

When **Alarm Switch** is set to On, the physiology alarm occurs if any measurement value of Systolic pressure, Mean pressure, or Diastolic pressure exceeds alarm limit. Users can adjust the alarm limit by accessing **XX Options (XX stands for the label name) > Setup > SYS Alarm / MAP Alarm / DIA Alarm**.

## Chapter 16 Monitoring CO<sub>2</sub>

### 16.1 Overview

The monitor provides the sidestream and mainstream methods for CO<sub>2</sub> monitoring. EDAN module and Respironics Sidestream CO<sub>2</sub> module are used for sidestream measuring, and Respironics Mainstream CO<sub>2</sub> module is used for mainstream measuring.

The principle of CO<sub>2</sub> measurement is primarily based on the fact that CO<sub>2</sub> molecule can absorb 4.3 $\mu$ m infrared ray. Absorption intensity is proportional to CO<sub>2</sub> concentration of patient sample, the CO<sub>2</sub> concentration will compute according to the detecting CO<sub>2</sub> absorption intensity of patient sample.

- Sidestream measurement takes a sample of the respiratory gas with a constant sample flow from the patient's airway and analyzes it with a remote CO<sub>2</sub> sensor. You can measure Sidestream CO<sub>2</sub> using the monitor's built-in CO<sub>2</sub> measurement.
- Mainstream measurement uses a CO<sub>2</sub> sensor attached to an airway adapter directly inserted into the patient's breathing system.

### 16.2 CO<sub>2</sub> Safety Information

---

**WARNING**

---

- 1 Do not use the device in the environment with flammable anesthetic gas.
  - 2 The device should be used by trained and qualified medical personnel authorized by EDAN.
  - 3 Nitrous oxide, elevated levels of oxygen, helium, xenon, halogenated hydrocarbons, and barometric pressure can influence the CO<sub>2</sub> measurement.
  - 4 The monitor will be damaged if any pipeline from the CO<sub>2</sub> module is disconnected, or the air tube /the air inlet /the air outlet are plugged by water or other materials.
  - 5 The accuracy of the CO<sub>2</sub> measurement will be affected by the following reasons: the airway was highly obstructed; the leakage of air way connection or quick variation of environment temperature.
  - 6 Follow precautions for electrostatic discharge (ESD) and electromagnetic interference (EMI) to and from other equipment.
  - 7 In the presence of electromagnetic devices (i.e., electrocautery), patient monitoring may be interrupted due to electromagnetic interference. Electromagnetic fields up to 20V/m will not adversely affect module performance.
  - 8 Do not place the sensor cables or tubing in any manner that may cause entanglement or strangulation.
  - 9 Do not store the CO<sub>2</sub> Module at temperatures less than -40° F (-40° C) or greater than 158° F (70° C). Do not operate the CO<sub>2</sub> Module at temperatures less than 32° F (0° C) or greater than 104° F (40° C).
-

**NOTE:**

After the low battery alarm appears, please do not start the CO<sub>2</sub> measurement, or the monitor may turn off for the low battery.

## 16.3 Monitoring Procedures

### 16.3.1 Zeroing the sensor

You must perform zeroing following the steps when using the new airway adapter.

1. Expose the sensor to room air and keep it away from all sources of CO<sub>2</sub> including the ventilator, the patient's breath and the operator's.
2. In the **CO<sub>2</sub> Setup** menu, please set the **Work Mode** to **Measure**.
3. For EDAN module, select **User Maintain > CO<sub>2</sub> Maintain**, and click **Zero**. For Respironics modules, click **Zero** in the **CO<sub>2</sub> Setup** menu.
4. If the system briefly displays **Zero In Progress**, the process is successful. After the zeroing calibration is finished, you can start CO<sub>2</sub> Monitoring. If the system displays **Breath detected** or **Zero required**, zeroing has failed. Zero calibration must be performed again.

### 16.3.2 Sidestream CO<sub>2</sub> Module

#### 16.3.2.1 Measurement Steps

##### **EDAN Module**

- 1 Fix the water trap to the water trap holder on the left side of the monitor.
- 2 Connect the sampling cannula or the sampling line to the water trap.
- 3 Set Work Mode to Measure.
- 4 For intubated patients, an airway adapter is required. For non-intubated patients, place the nasal cannula or the sampling mask onto the patient.

**NOTE:**

Disconnect the water trap from the holder or set **Work Mode** to **Standby** when the module is not in use.

##### **Respironics Sidestream Module**

- 1 Plug the sensor cable into the monitor's CO<sub>2</sub> input connector. Allow the sensor two minutes for warm-up.
- 2 Appropriately connect the cannula, airway adapter or sample line to the sensor. It will click into place when seated correctly.



Connecting Respironics Sidestream Module

- 3 To zero the sensor, please refer to zeroing the sensor.
- 4 For intubated patients, an airway adapter is required;

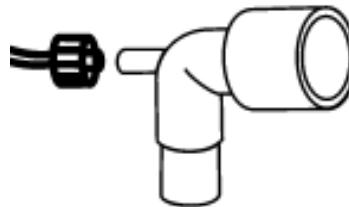
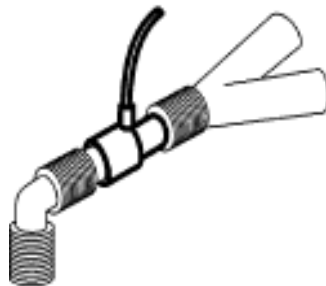

Air adapter

For non-intubated patients: Place the nasal cannula onto the patient.



Place the nasal cannula

**NOTE:**

- 1 You must perform a zero calibration as described in this procedure each time the ambient temperature changes more than 10°C (for example during transport).

- 2 Always connect the airway adapter to the sensor before inserting the airway adapter into the breathing circuit. In reverse, always remove the airway adapter from the breathing circuit before removing the sensor.
- 3 Always disconnect the cannula, airway adapter or sample line from the sensor when the sensor is not in use.

### 16.3.2.2 Removing Exhaust Gases from the System

---

**WARNING**

---

Anesthetics: When using the sidestream CO<sub>2</sub> measurement on patients who are receiving or have recently received anesthetics, connect the outlet to a scavenging system, to avoid exposing medical staff to anesthetics.

---

Use an exhaust tube to remove the sample gas to a scavenging system. Attach it to the sidestream sensor at the outlet connector.

### 16.3.3 Mainstream CO<sub>2</sub> Module

**NOTE:**

You must perform a zero calibration as described in this procedure each time you use a new airway adapter.



Respironics Mainstream CO<sub>2</sub> Module

#### 16.3.3.1 Measurement Steps

- 1 Attach the sensor connector to the CO<sub>2</sub> connector on the monitor.
- 2 Wait two minutes, allowing the sensor to reach its operating temperature and a stable thermal condition.
- 3 Choose the appropriate airway adapter and connect it to the sensor head. The airway adapter clicks into place when seated correctly.



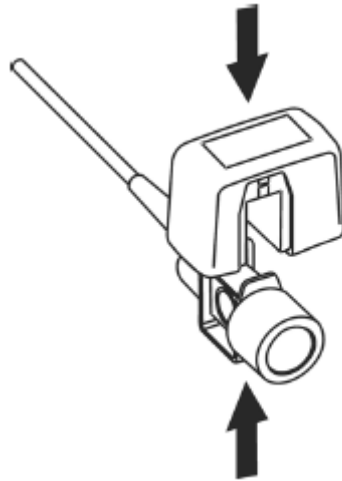

Connecting Sensor

- 4 To zero the sensor, please refer to zeroing the sensor.
- 5 Install the airway adapter at the proximal end of the circuit between the elbow and the ventilator Y-section.

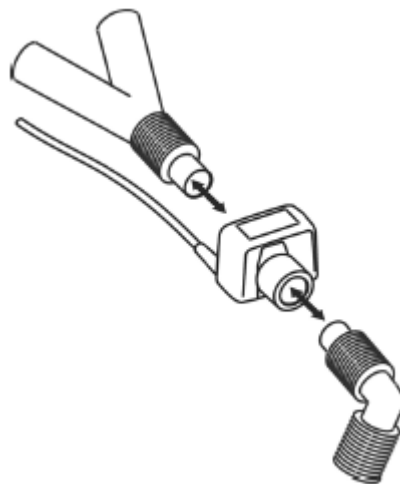

Connecting Airway Adapter

---

**WARNING**

- 1 No routine user calibration required.
  - 2 Accuracy is affected by temperature and barometric pressure.
  - 3 It is forbidden to insert or draw out the module when the monitor is working, for it can cause instability of the system. If you do it inadvertently, please turn off the module in menu immediately. The module enters STANDBY mode if you reconnect it to monitor which it is powered on. If the readings are inaccurate, you should do calibration.
-

**NOTE:**

- 1 Replace the airway adapter, if excessive moisture or secretions are observed in the tubing or if the CO<sub>2</sub> waveform changes unexpectedly without a change in patient status.
- 2 To avoid infection, use only sterilized, disinfected or disposable airway adapters.
- 3 Inspect the airway adapters prior to use. Do not use it if airway adapter appears damaged or broken. Observe airway adapter color coding for patient population.
- 4 Periodically check the flow sensor and tubing for excessive moisture or secretion buildup.

### 16.3.3.2 Removing Exhaust Gases from the System

---

**WARNING**

---

Anesthetics: when using the mainstream CO<sub>2</sub> measurement on patients who are receiving or have recently received anesthetics, connect the outlet to a scavenging system, to avoid exposing medical staff to anesthetics.

---

Use an exhaust tube to remove the sample gas to a scavenging system. Attach it to the mainstream sensor at the outlet connector.

## 16.4 Setting CO<sub>2</sub> Waveform Setup

Select the CO<sub>2</sub> waveform area to open the CO<sub>2</sub> waveform menu:

- Set **Mode** to **Curve** or **Filled** as your desire.
- Set **Sweep** to an appropriate value from the pop-up list. The bigger the value is, the quicker the speed is.

## 16.5 Setting CO<sub>2</sub> Corrections

Temperature, water vapor in the patient's breath, barometric pressure, and the proportions of O<sub>2</sub>, N<sub>2</sub>O and Helium in the mixture all influence CO<sub>2</sub> absorption. If values seem inaccurately high or low, check that the monitor is using the appropriate corrections.

For EDAN module, the following items are available in the **CO<sub>2</sub> Other Setup** menu: **N<sub>2</sub>O Compens.**, **O<sub>2</sub> Compens.**, **Anest. Agent**, **Vapor Compens.** and **Pump Rate**.

For Respirationics module, there are **Baro Press**, **O<sub>2</sub> Compens**, **Anes Agent** and **Balance Gas** in the **CO<sub>2</sub> Other Setup** menu.

## 16.6 Changing CO<sub>2</sub> Alarms

This refers to CO<sub>2</sub> specific alarms. See the Alarms section for general alarm information. To change the alarm, please refer to the following steps:

1. Select the **CO<sub>2</sub> Setup** menu;
2. Select **EtCO<sub>2</sub> Alarm Setup**, **FiCO<sub>2</sub> Alarm Setup** or **AwRR Alarm Setup** to adjust the alarm limit. About how to adjust the alarm limit, please refer to section Setting alarm limits.

## 16.7 Changing the Apnea Alarm Delay

This determines the time limit after which the monitor gives an alarm if the patient stops breathing.

1. Select the **CO<sub>2</sub> Setup** menu to open it;
2. Select **Apnea Alm** from the menu;
3. Choose the apnea alarm time from the pop-up list.

---

### WARNING

---

Safety and effectiveness of the respiration measurement method in the detection of apnea, particularly the apnea of prematurity and apnea of infancy, has not been established.

---

## Chapter 17 Monitoring C.O.

### 17.1 Overview

The Cardiac Output (C.O.) measurement is performed by using thermodilution method. The monitor can determine blood temperature, measure cardiac output. You can have iced injecta using either the flow through system or individual syringes of injecta. You can perform up to 6 measurements before editing the average Cardiac Output. The prompt message on the screen will tell you when to inject.

### 17.2 C.O. Safety Information

#### WARNING

- 1 Make sure that appurtenance applied is in conformity with relevant Medical Device Safety Requirements.
- 2 Appurtenance should be avoided from contact with conductive metal body when being connected or applied.

#### NOTE:

To replace the catheter thermistor, please enter the catheter computation coefficient into the **Constant** item according to the instruction.

### 17.3 C.O. Monitoring Procedures

1. Plug the C.O. interface cable into the C.O. socket and turn on the monitor.
2. Attach the injective probe connector and catheter thermistor connector to the appropriate parts of the cardiac output interface cable. And open the patient information window to confirm the patients' height and weight.
3. Pick the **CO Measure** item in the **CO Option** menu.
4. You can perform more than one measurement as required.
5. After the completion of the measurement, access the **CO Measure** window for **Review** to edit the measured data.

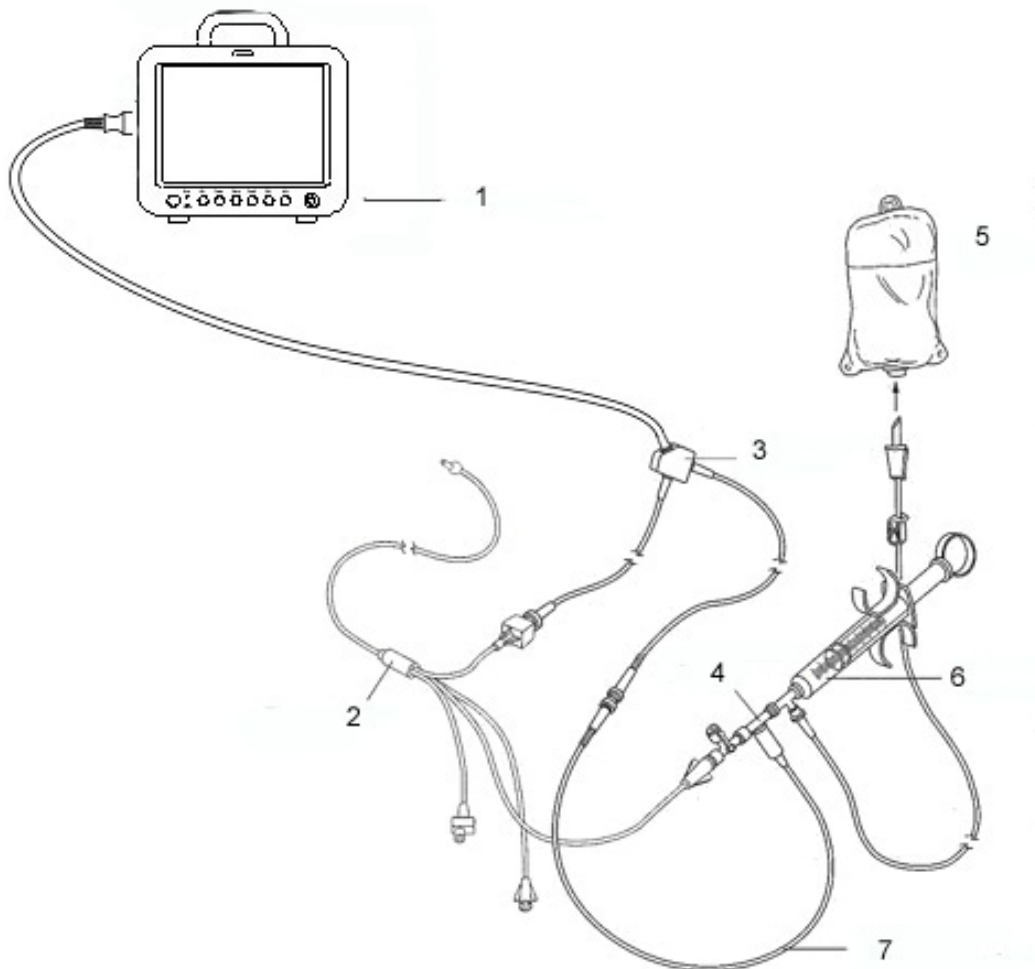

1: Monitor; 2: Thermodilution Catheter; 3: Cardiac Output Cable; 4: Injectate Sensor Housing; 5: Injectate; 6: Delivery System; 7: In-line injectate Temperature probe.

#### C.O. Sensor Connection

### WARNING

Make sure that the computational constant for the measurement is appropriate to the catheter used.

#### NOTE:

The blood temperature alarm will not function during C.O. measurement. It will resume automatically when the measurement is over.

## 17.4 C.O. Measurement Window

Select the **CO Option** menu to enter the **CO Measure** window and start C.O. measurement. If C.O. transducer is not connected, the monitor will display **No Sensor** on the screen.

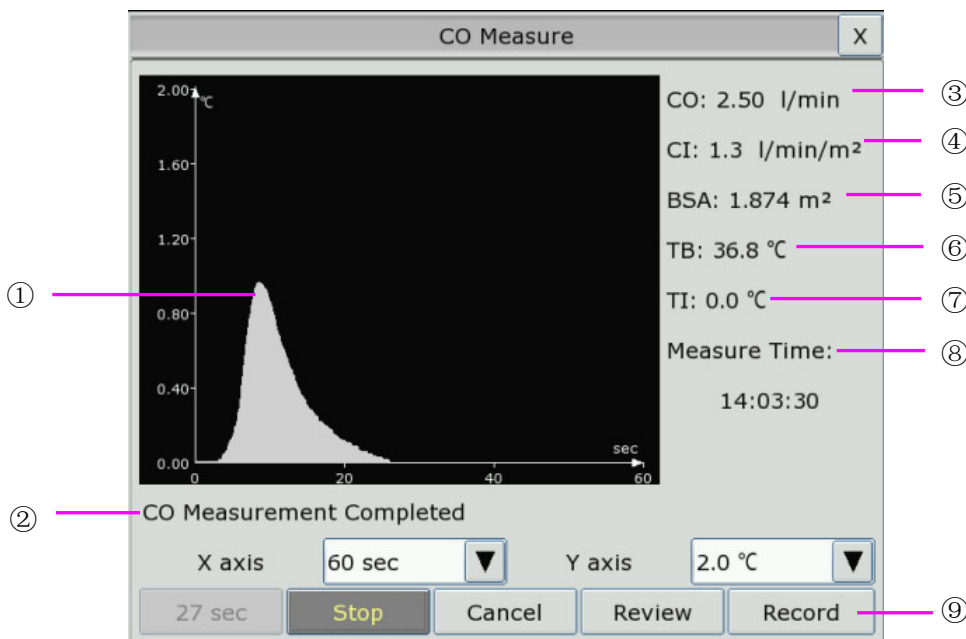

C.O. Measure Window

①	Measurement curve
②	Prompt message area
③	Cardiac Output
④	Cardiac Index
⑤	Body Surface Area
⑥	Blood Temperature
⑦	Injectate Temperature
⑧	Start time of the measurement
⑨	Function keys

The functional keys on the C.O. measure window are explained in the following table:

<b>Start</b>	Start a measurement
<b>Stop</b>	If the blood temperature cannot resume in a considerably long time, the measurement could not stop automatically. Use this button to stop the measurement and display the C.O., CI calculation result.
<b>Cancel</b>	Cancel the processing measurement or cancel the result after measurement.
<b>Record</b>	Print out the curve.

<b>Y axis</b>	Change the scale Y (temperature) value. Three models are available: 0~0.5°C, 0~1°C, 0~2.0°C. Adjust the scale by the temperature differences. A smaller scale results in a larger curve.
<b>X axis</b>	Change the Scale X (time) value. Two modes are available: 0~30s, 0~60s. If you start measurement in the 0~30s mode, it will be switched to 0~60s mode automatically if the measurement cannot finish within 30 seconds. After the switch, no further adjustment can be made to the Scale X.
<b>Review</b>	Enter the <b>Review</b> window

## 17.5 Measurement Process

Measurement should be taken when the message “**Ready for new measurement**” appears on the screen. Press the **Start** button, and then start injection. The thermodilution curve, current blood temperature and the injective temperature are displayed during the measurement. Curve drawing will stop automatically when the measurement finishes, and the C.O. and CI (③ and ④ in the above figure) will be calculated and displayed on the screen. The monitor will display C.O. in the parameter area and the start measurement time (⑧ in the above figure).

To ensure the accuracy of the measurement, it is suggested that a reasonable interval should take place between two consecutive measurements. The length of the interval can be set in the C.O. Setup menu (Time unit: second). The interval time counter is displayed on the screen. The next measurement cannot be performed until the time reduces to zero and a message **Ready for new measurement** appears.

### NOTE:

- 1 It is strongly recommended that the user must push the injector within four seconds after pressing the **Start** button.
- 2 It is strongly recommended that you wait at least 1 minute (or longer depending on the patient’s clinical condition) before starting the next measurement.

Repeat this procedure until you have completed the measurements you want.

You can perform a maximum of six measurement editing. If you perform additional measurements the earliest measurement each time will be deleted. If any of the curves in the editing window is not selected for calculation (excluded from the averaging calculations), the place will be taken by the new measurement.

## 17.6 Editing C.O.

Pick the **Review** button on the **CO Measure** menu to access the **Review** as shown below:

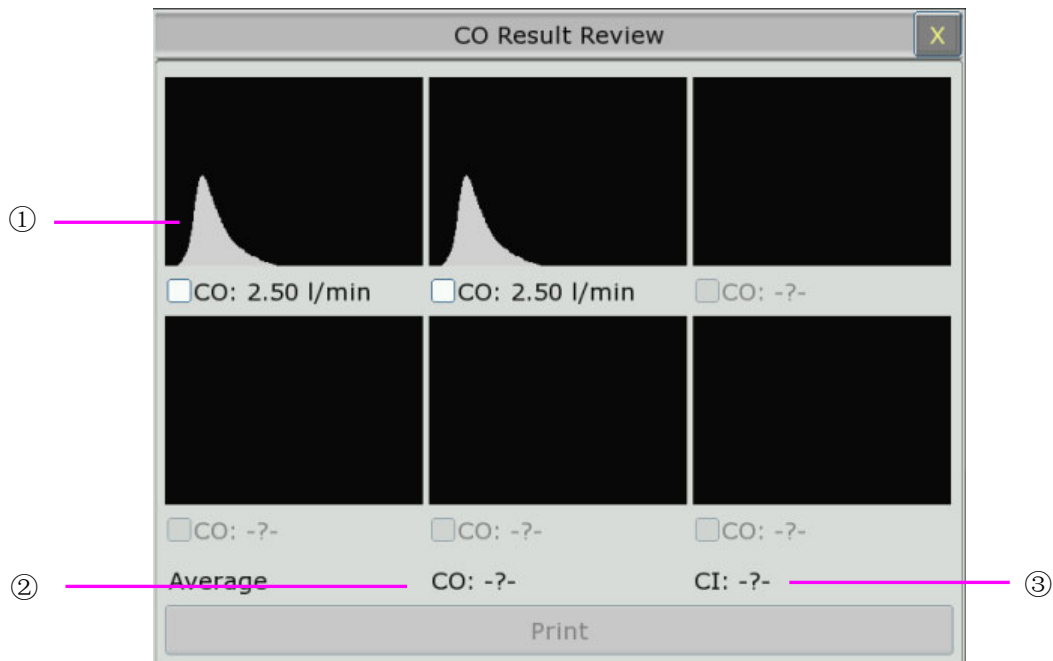

Window for C.O. Edit

◆ Contents displayed in the window:

①	Six curves of the six measurements and C.O. value
②	Average value of C.O.
③	Average value of CI

Values of selected measurements can be averaged and stored in the C.O. item in the HEMOD menu as the basis for Hemodynamic calculations.

## 17.7 Blood Temperature Monitoring

Blood temperature monitoring can function when C.O. measurement is not taken. The blood temperature is measured by the thermistor situated in the distal end of the flotation catheter in the pulmonary artery.

The blood temperature alarm function will not work during the C.O. measurement. When the measurement ends, the function will automatically resume.

The current blood temperature is displayed in the C.O. parameter area.



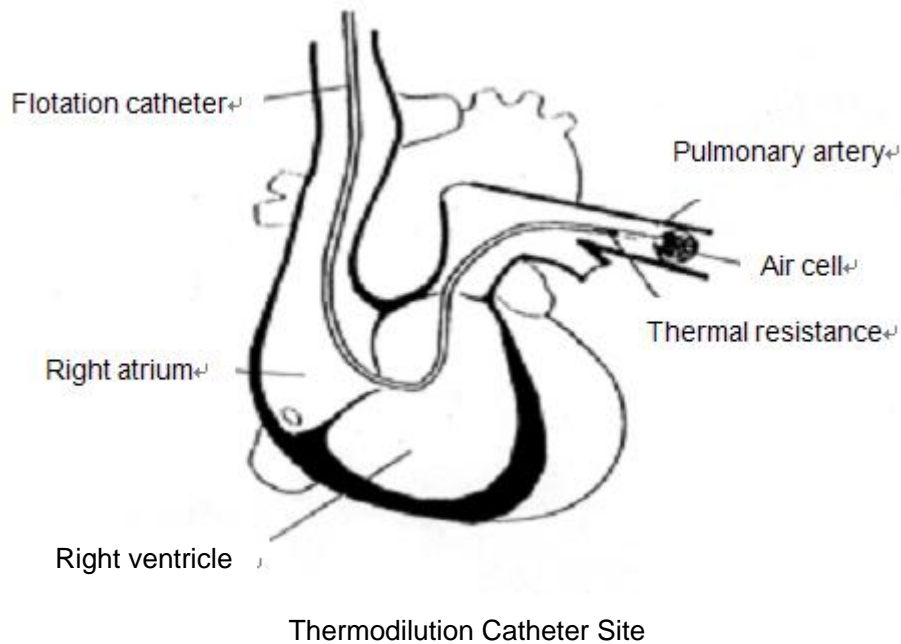

## 17.8 Setting the Computation Constant

The computation constant is associated with catheter and injective volume. When the catheter is changed, please adjust **Constant** in the **CO Setup** menu based on product description provided by the manufacturer.

## 17.9 Recording C.O. Measurements

C.O. measurement can be recorded by the recorder. To record the C.O. measurement, please select **Record** in the **CO Measure** menu.

## 17.10 Setting INJ. TEMP Source

To change the INJ Temp Source, please:

- 1 Select **Inj Temp Source** in the **CO Setup** menu;
  - 2 Select **Auto** or **Manual** from the list;
- **Manual**: directly displaying the injective temperature from INJ. TEMP.
  - **Auto**: indicating the system obtains the injective temperature through sampling.

## 17.11 Setting the Interval

You can set the minimum interval between two measurements in sequence by selecting **CO Option >CO Setup >Interval** and configuring **Interval** to a certain value by the second. No C.O. measurement can be taken during the interval.

The adjustable range of **Interval** is: 5 to 300 seconds.

## Chapter 18 Monitoring AG

### 18.1 Overview

The monitor uses ISA sidestream gas analyzer (hereinafter called ISA analyzer) and IRMA mainstream module (hereinafter called IRMA module) to monitor the anesthetic gas which can be used to measure the gases of adult, pediatric and neonatal patients during anesthesia, recovery and respiratory care. And the anesthetic gas includes Halothane (HAL), Isoflurane (ISO), Enflurane (ENF), Sevoflurane (SEV), Desflurane (DES), CO<sub>2</sub> and N<sub>2</sub>O.

### 18.2 Safety Information

#### 18.2.1 Safety Information for ISA Analyzer

---

**WARNING**

---

- 1 The ISA analyzer is intended for use by authorized and trained medical personnel only.
  - 2 Use only Nomoline sampling lines manufactured by PHASEIN.
  - 3 The ISA analyzer must not be used with flammable anesthetic agents.
  - 4 Carefully route the sampling line to reduce the risk of patient entanglement or strangulation.
  - 5 Do not re-use disposable sampling line.
  - 6 Do not lift the monitor by the sampling line as it could disconnect from the monitor, causing the monitor to fall on the patient.
  - 7 Used disposable sampling lines shall be disposed of in accordance with local regulations for medical waste.
  - 8 Do not use adult/pediatric type sampling line configurations with infants, as this may add dead space to the patient circuit.
  - 9 Do not use infant type sampling line configurations with adults, as this may cause excessive flow resistance.
  - 10 Do not use the ISA analyzer with metered-dose inhalers or nebulized medications as this may clog the bacteria filter.
  - 11 Check that the gas sample flow is not too high for the present patient category.
  - 12 Since a successful zeroing requires the presence of ambient air (21% O<sub>2</sub> and 0% CO<sub>2</sub>) in the gas analyzer, ensure that the ISA is placed in a well ventilated place. Avoid breathing near the ISA side stream gas analyzer before or during the zeroing procedure.
-

---

---

**WARNING**

- 13 The Nomoline sampling line and its interfaces are non-sterile devices. To avoid damage, do not autoclave any part of the sampling line.
  - 14 Never sterilize or immerse the ISA analyzer in liquid.
  - 15 Measurements can be affected by mobile and RF communications equipment. Make sure that the ISA analyzer is used in the electromagnetic environment specified in this manual.
  - 16 ISA analyzer is intended only as an adjunct in patient assessment. It must be used in conjunction with other assessments of clinical signs and symptoms.
  - 17 Replace the sampling line if the sampling line input connector starts flashing red, or a Nomoline occlusion message is displayed on the host.
  - 18 No modification of this equipment is allowed without authorization of the manufacturer. If this equipment is modified, appropriate inspection and testing must be conducted to ensure continued safe operation.
  - 19 ISA analyzers are not designed for MRI environments.
  - 20 Use of high frequency electrosurgical equipment in the vicinity of the monitor may produce interference and cause incorrect measurements.
  - 21 Do not use external ambient cooling of the ISA device.
  - 22 Do not apply negative pressure to the Nomoline to remove condensed water.
  - 23 Too strong positive or negative pressure in the patient circuit might affect the sample flow.
  - 24 Exhaust gases should be returned to the patient circuit or a scavenging system.
  - 25 Always use a bacteria filter on the evac side if sampled gas is intended to be re-breathed.
  - 26 Do not place the ISA analyzer in any position that might cause it to fall on the patient.
- 
- 

---

---

**CAUTION**

- 1 The ISA analyzers should be securely mounted in order to avoid the risk of damage to the ISA.
  - 2 Do not apply tension to the ISA analyzer cable.
  - 3 Do not operate the ISA analyzer outside the specified operating temperature environment.
- 
-

## 18.2.2 Safety Information for IRMA Module

### WARNING

- 1 The IRMA probe is intended for use by authorized and trained medical personnel only.
- 2 The IRMA probe must not be used with flammable anesthetic agents.
- 3 Disposable IRMA airway adapters shall not be reused. Used disposable airway adapters shall be disposed of in accordance with local regulations for medical wastes.
- 4 Use only PHASEIN manufactured oxygen sensor cells. Depleted oxygen sensors shall be disposed of in accordance with local regulations for batteries.
- 5 Do not use the IRMA Adult/Pediatric adapter with infants as the adapter adds 6 ml dead space to the patient circuit.
- 6 Do not use the IRMA airway adapter with adults as this may cause excessive flow resistance.
- 7 Measurements can be affected by mobile and RF communications equipment. It should be assured that the IRMA probe is used in the electromagnetic environment specified in this manual.
- 8 Do not place the IRMA airway adapter between the endotracheal tube and an elbow as this may allow patient secretions to block the adapter windows and result in incorrect operation.

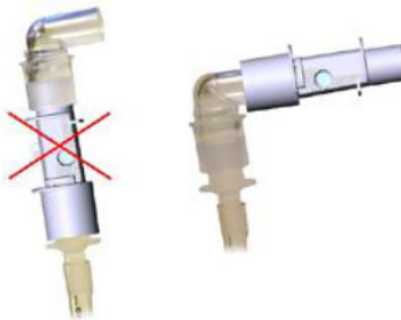

- 9 To keep secretions and moisture from pooling on the windows or oxygen sensor port, always position the IRMA probe in a vertical position with the LED pointing upwards.

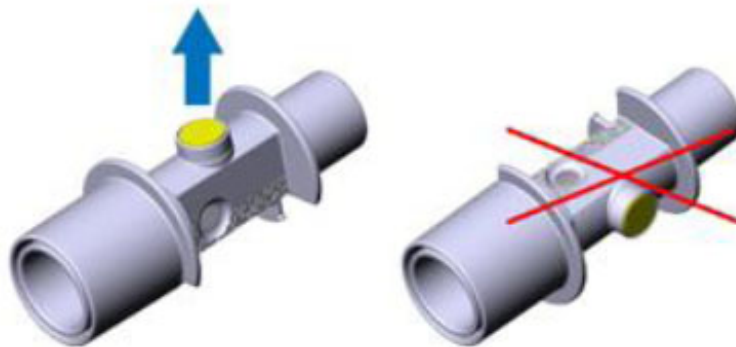

---

---

**WARNING**

- 10 Do not use the IRMA airway adapter with metered dose inhalers or nebulized medications as this may affect the light transmission of the airway adapter windows.
  - 11 Do not try to open the oxygen sensor assembly. The oxygen sensor is a disposable product and contains a caustic electrolyte and lead.
  - 12 The IRMA probe is intended only as an adjunct in patient assessment. It must be used in conjunction with other assessment of clinical signs and symptoms.
  - 13 Incorrect probe zeroing will result in false gas readings.
  - 14 Incorrect agent selection by the user for IRMA AX (no automatic agent identification) will result in false agent readings.
  - 15 Using IRMA AX (no automatic identification) with gas mixtures containing more than one agent will result in false agent readings.
  - 16 Replace the adapter if rainout/condensation occurs inside the airway adapter.
  - 17 Use only PHASEIN manufactured IRMA airway adapters.
- 
- 

---

---

**CAUTION**

- 1 Do not apply tension to the probe cable.
  - 2 Do not operate the IRMA probe outside the specified operating temperature environment.
  - 3 Do not leave depleted oxygen sensors mounted in the IRMA probe, even if the probe is not in use.
- 
- 

## 18.3 Monitoring Steps

### 18.3.1 Monitoring Steps for ISA Analyzer

#### 18.3.1.1 Performing a Pre-use Check

Before connecting the Nomoline sampling line to the breathing circuit, do the following:

1. Connect the sampling line to the ISA gas inlet connector (LEGI).
2. Check that the LEGI shows a steady green light (indicating that the system is OK).
3. For ISA OR+ and ISA AX+ module with O<sub>2</sub> option fitted: Check that the O<sub>2</sub> reading on the monitor is correct (21%).
4. Breathe into the sampling line and check that valid CO<sub>2</sub> waveforms and values are displayed on the monitor.
5. Occlude the sampling line with a fingertip and wait for 10 seconds.
6. Check that an occlusion alarm is displayed and that the LEGI shows a flashing red light.

7. If applicable: Perform a tightness check of the patient circuit with the sampling line attached.

### 18.3.1.2 System Setup for Analyzer

If your system is using the plug-in and measure ISA analyzer, please follow the setup instructions below:

1. Connect the ISA analyzer interface cable to the monitor.
2. Connect a Nomoline sampling line to the ISA analyzer input connector.
3. Connect the gas sample exhaust port to a scavenging system or return the gas to the patient circuit.
4. Power up the monitor.
5. A green LED indicates that the ISA analyzer is ready for use.
6. Perform a pre-use check as described in section Perform a pre-use Check.

### 18.3.1.3 Zeroing

The infrared module needs to establish a zero reference level for the CO<sub>2</sub>, N<sub>2</sub>O and anesthetic agent gas measurement. This zero calibration is here referred to as "zeroing".

ISA analyzer performs zeroing automatically by switching the gas sampling from the respiratory circuit to ambient air. The automatic zeroing is performed every 24 hours, and takes less than 3 seconds for ISA CO<sub>2</sub> module and less than 10 seconds for ISA analyzer.

If the ISA analyzer is fitted with an oxygen sensor, the automatic zeroing will also include room air calibration of the oxygen sensor.

---

#### WARNING

1. Since a successful zeroing requires the presence of ambient air (21% O<sub>2</sub> and 0% CO<sub>2</sub>) in the ISA analyzer, ensure that the ISA analyzer is placed in a well ventilated place. Avoid breathing near the ISA analyzer before or during the zeroing procedure.
  2. The sampling line should be replaced every two weeks, otherwise it is clogged.
- 

### 18.3.1.4 Maintenance

GAS readings should be verified by conducting the recommended maintenance checks. For details, please refer to Chapter *Maintenance*.

---

#### WARNING

1. The Nomoline sampling lines are non-sterile devices. To avoid damage, do not autoclave any parts of the sampling line.
  2. Never sterilize or immerse the ISA analyzer in liquid.
-

### 18.3.1.5 MAC Calculation

The MAC value may be calculated and displayed by using end-tidal (Et) gas concentrations according to the following formula:

$$MAC = \frac{\%Et(AA1)}{X(AA1)} + \frac{\%Et(AA2)}{X(AA2)} + \frac{\%Et(N2O)}{100}$$

X (AA): HAL=0.75%, ENF=1.7%, ISO=1.15%, SEV=2.05%, DES=6.0%

**NOTE:**

Altitude, patient age and other individual factors are not considered in the formula above.

### 18.3.2 Monitoring Steps for IRMA Module

- 1 Plug the IRMA connector into the IRMA input and switch the power on.
- 2 Snap the IRMA sensor head on the top of the IRMA airway adapter. It will click into place when properly seated.

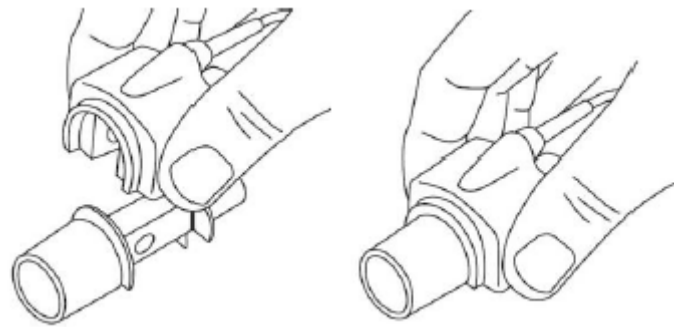

- 3 A green LED indicates that the IRMA probe is ready for use.



- 4 Connect IRMA/airway adapter 15mm male connector to the breathing circuit Y-piece.

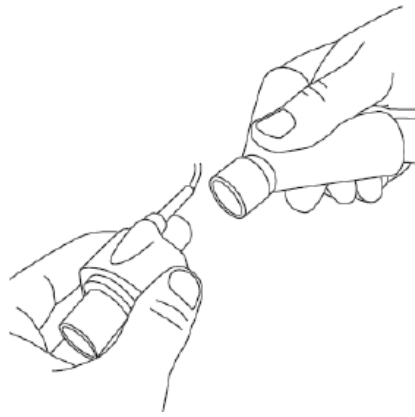

- 5 Connect the IRMA/airway adapter 15mm female connector to the patient's endotracheal tube.

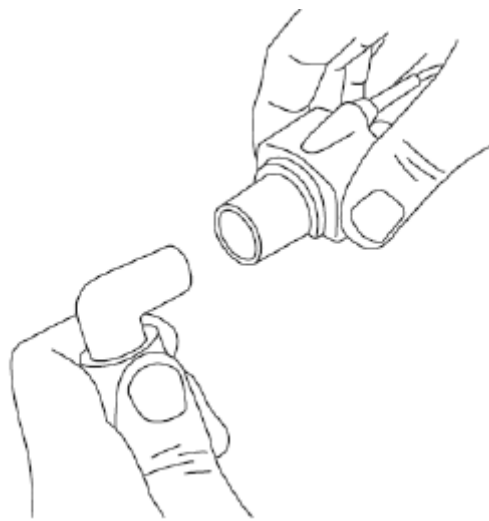

Alternatively, connect an HME (Heat Moisture Exchanger) between the patient's endotracheal tube and the IPMA probe. Placing an HME in front of the IRMA probe protects the airway adapter from secretions and effects of water vapor and eliminates the need of changing the adapter. It allows free positioning of the IRMA probe as well.

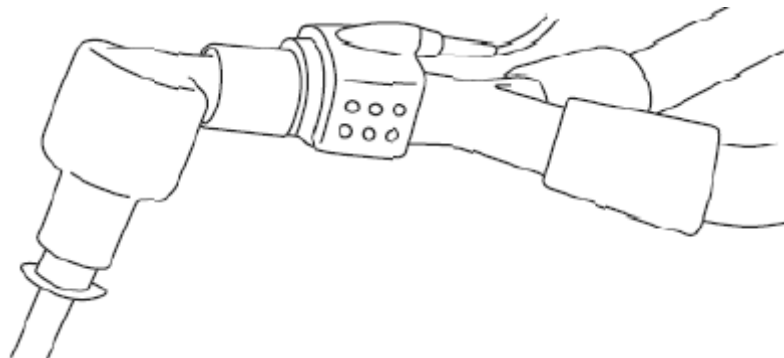

- 6 Unless the IRMA probe is protected with an HME always position the IRMA probe with the status LED pointing upwards.



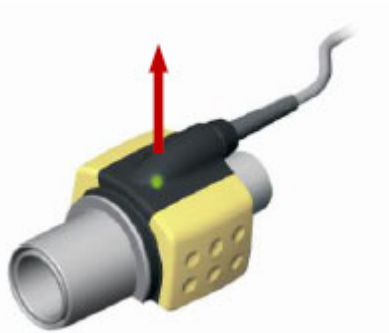

### 18.3.2.1 Placement of IRMA Probe

When connecting IRMA probe to an infant patient circuit, it is important to avoid a direct contact between the IRMA probe and the infant's body. If, for whatever the reason, the IRMA probe is in direct contact with any parts of the infant's body, an insulation material shall be placed between the IRMA probe and the body.

---

**WARNING**

---

The IRMA probe is not intended to be in long term skin contact.

---

### 18.3.2.2 Performing a Pre-use Check

Prior to connecting the IRMA airway adapter to the breathing circuit, verify the O<sub>2</sub> calibration by checking that the O<sub>2</sub> reading on the monitor is correct (21%). See the following section on how to perform air calibration.

Always verify gas readings and waveforms on the monitor before connecting the airway adapter to the patient circuit.

Perform the tightness check of the patient circuit with the IRMA probe snapped on the IRMA airway adapter.

### 18.3.2.3 Zeroing

---

**WARNING**

---

Incorrect probe zeroing will result in false gas readings.

---

In order to secure high precision of the IRMA probe measurements the following zeroing recommendations should be followed.

Zeroing is performed by snapping a new IRMA airway adapter onto the IRMA probe, without connecting the airway adapter to the patient circuit, and then using the host instrument to transmit a zero reference command to the IRMA probe.

Special care should be taken to avoid breathing near the airway adapter before or during the zeroing procedure. The presence of ambient air (21% O<sub>2</sub> and 0% CO<sub>2</sub>) in the IRMA airway adapter is of crucial importance for a successful zeroing. If a "ZERO-REQ" alarm should appear

directly after a zeroing procedure, the procedure has to be repeated.

Always perform a pre-use check after zeroing the probe.

#### **Zeroing for IRMA CO<sub>2</sub> probes:**

Zeroing needs to be performed **ONLY** when an offset in gas values is observed, or when an unspecified accuracy message is displayed.

Allow 10 seconds for warm up of the IRMA CO<sub>2</sub> probe after power on and after changing the IRMA airway adapter before proceeding with the Zeroing Procedure. The green LED on the probe will be blinking for approximately 5 seconds while zeroing is in progress.

#### **Zeroing for IRMA AX+ probes:**

Zeroing should be performed every time the IRMA airway adapter is replaced, or whenever an offset in gas values or an unspecified gas accuracy message is displayed.

Allow 30 seconds for warm up of the IRMA AX+ probes after power on and after changing the IRMA airway adapter before proceeding with the Zeroing Procedure. The green LED on the probe will be blinking for approximately 5 seconds while zeroing is in progress.

### **18.3.2.4 Cleaning**

The IRMA probe can be cleaned using a cloth moistened with maximum 70% ethanol or maximum 70% isopropyl alcohol.

Remove the disposable IRMA airway adapter prior to cleaning the IRMA probe.

#### **CAUTION**

- 1 The IRMA oxygen sensor cell and IRMA airway adapters are non-sterile devices. Do not autoclave the devices as this will damage them.
- 2 Never sterilize or immerse the IRMA probe in liquid.

### **18.3.2.5 MAC Calculation**

The MAC value may be calculated and displayed by using end-tidal (ET) gas concentrations according to the following formula:

$$\text{MAC} = \% \text{ET}(\text{AA}_1) / \text{X}(\text{AA}_1) + \% \text{ET}(\text{AA}_2) / \text{X}(\text{AA}_2) + \% \text{ET}(\text{N}_2\text{O}) / 100$$

X(AA): HAL=0.75%, ENF=1.7%, ISO=1.15%, SEV=2.05%, DES=6.0%

## **18.4 Setting Work Mode**

There are two work modes: **Measure** and **Standby**. To change the work mode, please refer to the following steps:

- 1 Select the **AG Setup** menu;
- 2 Select **Work Mode** on the interface and select **Measure** or **Standby** from the popup list.

## 18.5 Setting Alarms

Here we take CO<sub>2</sub> alarm for example. This refers to CO<sub>2</sub> specific alarms. See the Alarms Chapter for general alarm information. To change the alarm, please refer to the following steps:

- 1 Select the **CO<sub>2</sub> Setup** menu;
- 2 Select **EtCO<sub>2</sub> Alarm High Limit** or **EtCO<sub>2</sub> Alarm Low Limit** to adjust the alarm limit.

## 18.6 Setting Apnea Alarm Time

This determines the time limit after which the monitor gives an alarm if the patient stops breathing.

- 1 Select the **AG Setup** menu to open it;
- 2 Select **Apnea Alarm** from the menu;
- 3 Choose the apnea alarm time from the pop-up list.

## 18.7 Working Status of ISA analyzer

Working status of the ISA analyzer can be indicated by the indicator. For the detailed information, please refer to the following table.

Indication	Status
Steady green light	System OK
Blinking green light	Zeroing in progress
Steady blue light	Anesthetic agent present
Steady red light	Sensor error
Blinking red light	Check sampling line

## 18.8 Working Status of IRMA Module

The working status of the IRMA module can be transmitted by the IRMA probe. For the detailed information, please refer to the following table.

Indication	Status
Steady green light	System OK
Blinking green light	Zeroing in progress
Steady blue light	Anesthetic agent present
Steady red light	Sensor error
Blinking red light	Check adapter

## 18.9 N<sub>2</sub>O and O<sub>2</sub> Compensations

The following models need O<sub>2</sub> compensation: IRMA AX+, IRMA CO<sub>2</sub>, ISA AX+, ISA CO<sub>2</sub>. The following models need N<sub>2</sub>O compensation: IRMA CO<sub>2</sub> and ISA CO<sub>2</sub>. For the compensation details, please refer to the following table.

O <sub>2</sub> Range	SetO <sub>2</sub> Range
0~30 vol%	21
30~70 vol%	50
70~100 vol%	85

N <sub>2</sub> O Range	Set N <sub>2</sub> O Range
0~30 vol%	0
30~70 vol%	50

## 18.10 Effects of humidity

The partial pressure and the volume percentage of CO<sub>2</sub>, N<sub>2</sub>O, O<sub>2</sub> and anesthetic agents depend on the amount of water vapor in the measured gas. The O<sub>2</sub> measurement will be calibrated to show 20.8 vol% at actual ambient temperature and humidity level, instead of showing actual partial pressure. 20.8 vol% O<sub>2</sub> corresponds to the actual O<sub>2</sub> concentration in room air with 0.7 vol% H<sub>2</sub>O concentration (at 1013 hPa this equals for example 25°C and 23% RH). The measurement of CO<sub>2</sub>, N<sub>2</sub>O, and anesthetic agents (e.g. all gases measured by the IR-bench) will always show the actual partial pressure at the current humidity level.

In the alveoli of the patient, the breathing gas is saturated with water vapor at body temperature (BTPS).

When the breathing gas flows through the sampling line, the gas temperature will adapt to ambient before reaching the gas analyzer. As the NOMO section removes all condensed water, no water will reach the ISA gas analyzer. The relative humidity of the sampled gas will be about 95%.

If CO<sub>2</sub> values at BTPS are required, the following equation can be used:

$$EtCO_2(BTPS) = EtCO_2 * \left( 1 - \left( \frac{3.8}{P_{amb}} \right) \right)$$

where:

**EtCO<sub>2</sub>** = EtCO<sub>2</sub> value sent from ISA [vol %]

**P<sub>amb</sub>** = Ambient pressure sent from ISA [kPa]

**3.8** = Typical partial pressure of water vapor condensed between patient circuit and ISA [kPa]

EtCO<sub>2</sub>(BTPS) = EtCO<sub>2</sub> gas concentration at BTPS [vol%]

O<sub>2</sub> is assumed to be room air calibrated at a humidity level of 0.7 vol% H<sub>2</sub>O.

## Chapter 19 Freeze

### 19.1 Overview

When monitoring a patient, the user may freeze the waveforms and examine them. Generally, the user can review a frozen waveform of a maximum of 120 seconds. The freeze function of this monitor has the following features:

- Freeze status can be activated on any operating screen.
- Once entering the Freeze status, the system exits all other operating menus. Besides, the system freezes all waveforms in the Waveform area of the Basic Screen, and also freezes Full Lead ECG waveforms and extra waveforms on the Full Lead ECG interface (if any). Nevertheless the Parameter area refreshes normally.
- The frozen waveforms can be reviewed and recorded.

### 19.2 Entering/Exiting Freeze Status

#### 19.2.1 Entering Freeze Status

In the Non-Freeze status, press the  button on the control panel of the monitor to exit the current menu. Freeze status is entered and the popup **Freeze** menu is displayed. In Freeze status, all waveforms are frozen and will no longer be refreshed.

#### 19.2.2 Exiting Freeze Status

In the Freeze status, executing any of the following operations will command the system to exit the Freeze status:

- Select the **Exit** option in/from the **Freeze** menu;
- Press the  button on the control panel again;
- Execute any operation that may trigger the adjustment of the screen or the display of a new menu.

After exiting Freeze status, the system will clear screen waveforms and resume displaying real-time waveforms. In the Screen Refresh mode, the system will sweep the waveforms from left to right in the Waveform Area.

Press the  button on the control panel, and the **Freeze** menu will appear on the bottom part of the screen. At the same time, the system freezes the waveforms.

- **REC WAVE:** it can be set to any waveform of 8s, such as **IBP1, CO<sub>2</sub>, and PLETH** etc. It can also be set to **OFF**.
- **Review:** Used to review frozen waveforms.
- **Exit:** The system closes the **Freeze** menu and exits the Freeze status.

**NOTE:**

Pressing the  button repeatedly over a short period of time may result in discontinuous waveforms on the screen.

### 19.3 Reviewing Frozen Waveform

By moving the waveform, you may review a waveform of 120 seconds before it is frozen. For a waveform of less than 60 seconds, the remaining part is displayed as a straight line. Use the rotary knob on the control panel to move the cursor to the **Review** option in the **Freeze** menu. Press the knob. By turning the knob left or right, frozen waveforms on the screen will move left or right correspondingly. There is an arrow indicating upward on the right side of the last waveform.

## Chapter 20 Review

The monitor provides 120-hour trend data of all parameters, storage of 1200 NIBP measurement results and 60 alarm events. This chapter gives detailed instruction for review of all data.

### 20.1 Trend Graph Review

- The latest 1-hour trend is displayed every 1 or 5 seconds.
- The latest 120-hour trend is displayed every 1, 5 or 10 minutes.

To review Trend Graph, please press the **Trend Graph** key on the screen or select **Menu > Review > Trend Graph**, then the trend graph interface is displayed.

In the trend graph, the y-axis stands for the measurement value and x-axis stands for the time.

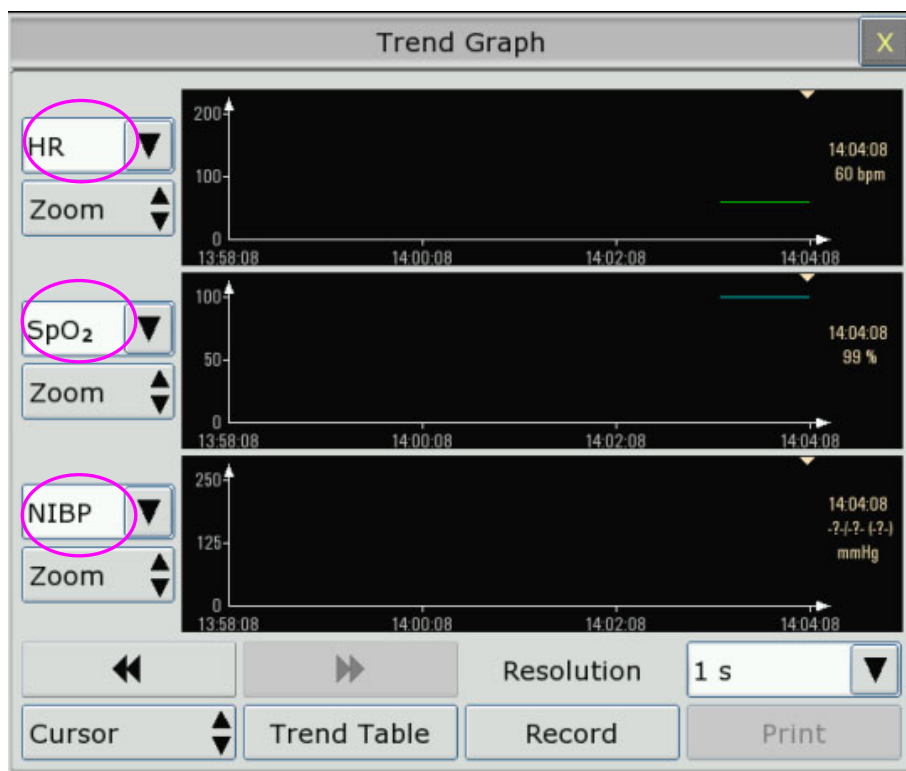

#### 20.1.1 Selecting Trend Graph of Specific Parameter

The monitor can review trend graph of different parameters. To change the existing trend graph, please select **Menu > Review > Trend Graph** and select a required parameter name from the popup list (as shown in red text in the above figure).



#### 20.1.2 Adjusting Trend Scale

You can use **Zoom** on the trend graph review interface to adjust the trend scale. Once you adjust the trend scale on the trend graph review interface, you also change the trend scale of the related parameters for the screen trend displayed on the main screen.

### 20.1.3 Setting Resolution

The monitor can support five kinds of resolutions. To set an appropriate resolution, please select **Menu > Review > Trend Graph** and an interface is displayed. Choose **Resolution** on the interface to open the list and select an appropriate resolution among **1 sec, 5 sec, 1 min, 5 min** and **10 min**.

### 20.1.4 Scrolling Left and Right the Screen

All trend graphs can't be displayed on the current screen due to the screen limitation. The user can scroll left and right the screen manually to see measurement trends that do not fit in the current view by selecting and pressing the symbol  and  displayed on the trend graph.

### 20.1.5 Switching to the Trend Table

The user can switch to the trend table interface on the **Trend Graph** interface. To do so, please select **Menu > Review > Trend Graph** and select the **Trend Table** option from the popup interface.

### 20.1.6 Record

The monitor can make a tabular trend recording of the data in the current trend graph window. The report will use the current trend interval settings. For the detailed information about recording the trend graph, please refer to Chapter *Recording*.

## 20.2 Trend Table Review

To review the trend table, please press the **Trend Table** key on the screen or select **Menu > Review > Trend Table**, then the trend table is displayed.

#### **NOTE:**

The CO<sub>2</sub> module and AG module cannot be measured at the same time, so their trend graph cannot be displayed at the same time.





### 20.2.1 Setting Resolution

The monitor can support seven kinds of interval. To set an appropriate resolution, please select **Menu > Review > Trend Table** and an interface is displayed. Choose **Resolution** on the interface to open the list and select an appropriate interval among **1 sec, 5 sec, 1 min, 5 min, 10 min, 30 min** and **60 min**.

### 20.2.2 Scrolling the Screen

All trend tables can't be displayed on the current screen due to the screen limitation. The user can scroll left, right, up and down the screen manually to see measurement trend tables that do not fit



in the current view by selecting and pressing the symbol , ,  and  displayed on the trend graph.

### 20.2.3 Switching to Trend Graph

The user can switch to the trend graph on the **Trend Table** interface. To do so, please select **Menu > Review > Trend Table** and select the **Trend Graph** option from the popup interface.



### 20.2.4 Recording

The monitor can make a tabular trend recording of the data in the current trend graph window. The report will use the current trend interval settings. For the detailed information about recording the trend table, please refer to Chapter *Recording*.

## 20.3 NIBP Review

To review the NIBP measurement data, select the **NIBP Review** key on the screen or select **Menu > Review > NIBP Review**, then the **NIBP Review** window is displayed.

### 20.3.1 Scrolling the Screen

All measurement data can't be displayed on the current screen due to the screen limitation. The user can scroll up and down the screen manually to see measurement data that doesn't fit in the current view by selecting and pressing the symbol  and  displayed on the **NIBP Review** interface.

### 20.3.2 Recording



The monitor can record the measurement data in the NIBP review window. For the detailed information about recording the NIBP review, please refer to Chapter *Recording*.

## 20.4 Alarm Review

The monitor can display up to 10 technical alarm events in the current screen.

To review the alarm event, select the **Alarm Review** key on the screen or select **Menu > Review > Alarm Review**, then the **Alarm Review** Window is displayed.

### 20.4.1 Scrolling the Screen

All alarm events can't be displayed on the current screen due to the screen limitation. The user can scroll up and down the screen manually to see alarm events that don't fit in the current view by selecting and pressing the symbol  and  displayed on the **Alarm Review** interface.

## 20.4.2 Selecting Alarm Event of Specific Parameter

The monitor can review alarm event of the specific parameters. To view the alarm event of the specific parameter, please select **Menu > Review > Alarm Event** and choose **Event Type** to select the required parameter name from the popup list.

## 20.4.3 Setting Time Index

The user can set end time of alarm review by selecting the **Time Index** option displayed on the alarm review interface.



If the user selects **Current Time** on the popup interface, the alarm events occurring before the current time are displayed on the alarm event review interface.

If the user selects **User Define**, he can define the review time by setting time box displayed on the interface. The alarm events occurring before the **User Define** option are displayed on the alarm event review interface.

## 20.5 Arr Review

Select **ECG Setup > Arr Analysis> Arr Review** or **Menu > Review > Arr Review** to open the Arr review interface. The interface displays the latest arrhythmia events.

### 20.5.1 Scrolling the Screen



All arrhythmia events can't be displayed on the current screen due to the screen limitation. The user can scroll up and down the screen manually to see the other arrhythmia events that do not fit in the current view by selecting and pressing the symbol  and  displayed on the **Arrhythmia Review** interface.

## 20.6 12-lead Diagnosis Review

Select **Menu > Review > Analysis Review** to open the 12-lead analysis review interface.



### 20.6.1 Scrolling the Screen

All analysis results or waveforms can't be displayed on the current screen due to the screen limitation. The user can scroll up and down the screen manually to see the analysis results or waveforms that do not fit in the current view by selecting and pressing the symbol  and  displayed on the 12-lead analysis review interface.

### 20.6.2 Deleting Diagnosis Results

The user can delete the analysis results displayed on the current screen by selecting **Delete** on the interface.

### 20.6.3 Switching Between Waveforms and Results

The user can review the analysis waveforms on the analysis result interface by selecting the **Wave** option and review the analysis results on the analysis waveform interface by selecting the **Results** option.

### 20.6.4 Recording

The monitor can record the 12-lead diagnosis waveforms or results displayed on the current screen. To do so, press **Record** on the interface. For the detailed information about recording the diagnosis waveforms or results, please refer to Chapter *Recording*.

## Chapter 21 Calculation and Titration Table

The monitor provides calculation function and titration table. Calculations are patient data that are not directly measured but calculated by the monitor.

The monitor can perform drug calculation and hemodynamic calculation.

### NOTE:

The drug calculation function acts only as a calculator. The patient weights in Drug Calculation menu and in Patient Information menu are independent of each other. Therefore changing the Weight in Drug Calculation menu will not change the weight in the Patient Information menu.

### 21.1 Drug Calculation

#### 21.1.1 Calculation Procedures

The drug calculation window is displayed by selecting **Menu > Common Function > Drug Dose**. Select the right pull-down box of the **Drug** option and select the required drug name among the 15 drugs which are listed as follows. And the drug name of Drug A, Drug B, Drug C, Drug D and Drug E can be defined by the user.

- Drug A, Drug B, Drug C, Drug D and Drug E
- AMINOPHYLLINE
- DOBUTAMINE
- DOPAMINE
- EPINEPHRINE
- HEPARIN
- ISUPREL
- LIDOCAINE
- NIPRIDE
- NITROGLYCERIN
- PITOCIN

The system generates values that can't be treated the calculation results. The user must enter the correct parameter value based on the doctor's instruction.

- Enter the patient's weight.
- Enter the correct parameter value.
- Confirm whether the calculation result is correct.

The following formulas are applied to dose calculation:

Concentrate= Amount / Volume

INF Rate= DOSE / Concentrate

Duration= Amount / Dose

Dose= Rate × Concentrate

DRIP Rate= INF Rate / 60 × DROP Size

### 21.1.2 Calculation Unit

Each drug has the fixed unit or unit series to calculate. Among the same unit series, the unit binary varies with the entered parameter value.

The calculation units of the drugs are listed as follows:

Drug	Unit
DRUG A, DRUG B, DRUG C, AMINOPHYLLINE, DOBUTAMINE, DOPAMINE, EPINEPHRINE, ISUPREL, LIDOCAINE, NIPRIDE, NITROGLYCERIN	g, mg, mcg
DRUG D, PITOCIN, HEPARIN	Ku, mu, Unit
DRUG E	mEq

When defining a drug, select Drug A, Drug B, Drug C, Drug D, and Drug E based on the unit series.

#### NOTE:

- 1 The drug calculation is displayed as invalid value before the user edits the drug name and patient weight, and the user can't enter any value.
- 2 Drip Rate and Drop Size are invalid in the neonatal mode.



## 21.2 Titration Table

After completing the drug calculation, the user can open the **Titration** on the **Drug Dose** interface.

The user can change the following items in the titration table:

- Basic
- Step
- Dose Type

The data in the trend table will vary with the changes above. And the user can perform the following:

- Scroll up and down the screen by selecting and pressing the symbol  and  displayed on the trend graph.
- Record the data displayed in the current window by selecting **Record**.

## 21.3 Hemodynamic Calculation

### 21.3.1 Calculation Procedure

1. The hemodynamic calculation interface is displayed by selecting **Menu > Common Function > Hemodynamic**.
2. The user must input parameter value manually on this interface.
3. Select **Calculate** to output parameter value.
4. Select **Confirm** or **Cancel** to exit this menu.

### 21.3.2 Input Parameters

Abbreviation	English Full Name/Description
PAWP	Pulmonary artery wedge pressure
CVP	Central venous pressure
HR	Heart rate
AP MAP	Mean Artery Pressure
LV_D	Left Ventricular Diameter
PA MAP	Pulmonary artery mean pressure
HT	Height
WT	Weight

### 21.3.3 Output Parameters

Abbreviation	English Full Name/Description
BSA	Body surface area
SV	Stroke volume
SVI	Stroke volume index
SVR	Systemic vascular resistance
SVRI	Systemic vascular resistance index
PVR	Pulmonary vascular resistance
PVRI	Pulmonary vascular resistance index
LCW	Left cardiac work
LCWI	Left cardiac work index
RCW	Right cardiac work
RCWI	Right cardiac work index
LVSW	Left ventricular stroke work

LVSWI	Left ventricular stroke work index
RVSW	Right ventricular stroke work
RVSWI	Right ventricular stroke work index
EF	Ejection fraction

## Chapter 22 Recording

### 22.1 General Information

A thermal dot matrix recorder is used for the monitor and can support many recording types and output patient information, measurement data, review data waveform and so forth.



1	Recording indicator
2	Paper feeding key: press this key to start or stop feeding recording paper without outputting anything on the paper
3	Paper outlet
4	Recorder door

### 22.2 Performance of the Recorder

- Waveform record is printed at the rate of 25 mm/s or 50 mm/s.
- 48mm wide printout paper.
- It can record up to three waveforms.
- User-selectable real-time recording time and waveform.
- Auto recording interval is set by the user, and the waveform is in accordance with the real time recording.

**NOTE:**

It is suggested that the user should not use the recorder when the low battery displays, or the monitor may be turned off automatically.



## 22.3 Recording Type

The monitor provides several types of stripe recording:

- Continuous real-time recording
- 8 seconds real-time recording
- Time recording
- Alarm recording
- Trend graph recording
- Trend table recording
- NIBP review recording
- Arrhythmia review recording
- Alarm review recording
- Titration recording
- Hemodynamic Calculation result recording
- 12-lead analysis recording
- C.O. measurement recording

## 22.4 Starting and Stopping Recording

You can start and stop the recording in the following ways:

Continuous real-time recording	Press the <b>Record</b> button on the front panel to start the recording, and repress it to stop the recording.
8 seconds real-time recording	Record three waveforms selected in <b>Recorder Setup</b> menu according to the setup time interval in <b>Recorder Setup</b> menu. It will automatically stop in 8 seconds.
Trend graph recording	Enter the <b>Menu &gt; Review &gt; Trend Graph</b> menu, and press the <b>Record</b> button to start recording. Press the <b>Record</b> button on the front panel to stop recording.
Trend table recording	Enter the <b>Menu &gt; Review &gt; Trend Table</b> menu, and press the <b>Record</b> button to start recording. Press the <b>Record</b> button on the front panel to stop recording.
NIBP review recording	Enter the <b>Menu &gt; Review &gt; NIBP Review</b> menu, then press the <b>Record</b> button to start recording. Press the <b>Record</b> button on the front panel to stop recording.
Arrhythmia review recording	Enter the <b>Menu &gt; Review &gt; ARR Review</b> menu, and select one arrhythmia alarm, then press the <b>Record</b> button to start recording. Press the <b>Record</b> button on the front panel to stop recording.

Alarm review recording	Enter the <b>Menu &gt; Review &gt; Alarm Review</b> menu, and select one alarm, then press the <b>Record</b> button to start recording. Press the <b>Record</b> button on the front panel to stop recording.
Drug calculation titration recording	Enter the <b>Menu &gt; Common Function &gt; Drug Dose &gt; Titration</b> menu, then press the <b>Record</b> button to start recording. Press the <b>Record</b> button on the front panel to stop recording.
Hemodynamic Calculation result recording	Enter the <b>Menu &gt; Common Function &gt; Hemod Dynamics</b> menu, then press the <b>Record</b> button to start recording. Press the <b>Record</b> button on the front panel to stop recording.
12-lead diagnosis recording	Enter the <b>ECG Setup &gt; 12-L Review</b> menu, then press the <b>Record</b> button to start recording. Press the <b>Record</b> button on the front panel to stop recording.
C.O. measurement recording	Enter the <b>C.O. Option &gt; C.O. Measure</b> menu, then press the <b>Record</b> button to start recording. Press the <b>Record</b> button on the front panel to stop recording.

The recorder will stop recording in the following situations:

- The recording task is finished.
- No paper in the recorder.
- Malfunction stops the recorder from running properly.

**NOTE:**

You can press the  button on the front panel to stop the currently recording process.

## 22.5 Recorder Operations and Status Messages

### 22.5.1 Record Paper Requirement

Only standard thermosensitive record paper can be used: otherwise the recorder may not function, the recording quality may be poor, and the thermosensitive printhead may be damaged.

### 22.5.2 Proper Operation

- When the recorder is working, the record paper goes out steadily. Do not pull the paper outward with force: otherwise the recorder may be damaged.
- Do not operate the recorder without record paper.

### 22.5.3 Paper Out

When the **Recorder Out OF Paper** alarm is displayed, the recorder cannot start. Please insert record paper properly.

### 22.5.4 Replacing Paper

1. Pull outwards the upper arc part of the recorder casing to release the casing, shown in the following figure.



2. Insert a new roll of paper into the paper cassette, printing side facing upwards.



3. Ensure proper position and tidy margin.



4. Pull about 2cm of the paper out, and close the recorder casing.

**NOTE:**

Be careful when inserting papers. Avoid damaging the thermo-sensitive print head. Unless when inserting papers or shooting troubles, do not leave the recorder catch open.

### 22.5.5 Removing Paper Jam

When the recorder functions or sounds improperly, you should open the recorder casing to check for a paper jam. Remove the paper jam in the following way:

- Cut the record paper from the feeding edge.
- Open the recorder casing.
- Re-insert the paper.

**NOTE:**

If the monitor is not installed with a recorder, it will indicate **RECORDER SETUP NEEDED** after pressing the **Record** button.

## Chapter 23 Other Functions

### 23.1 Nurse Call

The monitor provides dedicated nurse call port which is connected to nurse call system through the nurse call cable to perform the nurse call function. You should activate the function following the steps below:

1. Select **Menu > Maintenance > User Maintain**, and input the password **ABC**;
2. Select **Other Setups> Aux Output**;
3. Choose **On** in the **Nurse Call** list.

### 23.2 Analog Output and Defibrillator Synchronization

The monitor provides analog output signals to accessory equipment. Also, if a defibrillator is connected to the monitor, a defibrillator synchronization pulse can be output. You should activate the function following the steps below:

1. Select **Menu > Maintenance > User Maintain**, and input the password **ABC**;
2. Select **Other Setups> Aux Output**;
3. Choose **Analog Output** or **Defibrillation** in the **Aux Output** list.

### 23.3 Storing Data in a Removable Device

#### 23.3.1 Data Stored in the Removable Device

A single piece of patient data maximally contains the following information:

Patient information	MRN, name, date of birth, date of admission, gender, type, height, weight, blood type, pace, doctor, bed No., department
Trend graph and trend table	a maximum of 10 days
NIBP measurement review	1200 sets
Alarm review	60 sets
Arrhythmia event	60 sets
12-lead diagnosis review	50 sets
Waveforms	48 hours

### 23.3.2 Activating/ Deactivating Data Storing

To activate/ deactivate the data storing function, select **Menu> Maintenance> User Maintain > Other Setups**, and set **Data Store** to **On/ Off**.

The monitor will stop storing data in the removable device under the following circumstances:

- The removable device is unplugged.
- There is no enough space in the removable device for storing data.
- The removable device is read-only.
- The data storing function is deactivated.
- The monitor is switched off.
- The power supply is off.

### 23.3.3 Selecting a Removable Device

You may plug several removable devices into the monitor at the same time, but only one is operative. You can select a removable device as a working one among the plugging devices by selecting **Menu> Removable Device** and choosing the device name from the list. By default, the first plugged removable device is the working one.

---

#### CAUTION

- 1 Not all the removable devices are compatible with the monitor, Use the removable devices recommended by EDAN.
  - 2 Do not set the read-only switch on the removable device to on when the removable device is inserted in the monitor.
- 

### 23.3.4 Reviewing Data Stored in a Removable Device

To review data stored in a removable device, select **Menu> Review> External Data**, and choose a patient from the list to review the data including patient information, trend graph, trend table, NIBP measurements, arrhythmia event, alarm event, 12-lead diagnosis and waveform.

#### NOTE:

12-lead diagnosis review is only applicable to iM80.

### 23.3.5 Deleting Data Stored in a Removable Device

To delete data of one patient, choose the patient from the list after selecting **Menu> Review> External Data**, and then click **Delete Data** on the **Review** menu. Further confirmation of deletion is required.

To delete data of all patients, select **Menu> Review> External Data** and click **Delete all data** on the **External Data Review** menu. Further confirmation is required.

### 23.3.6 Ejecting a Removable Device

Before unplugging a removable device from the monitor, you need to select **Menu > Removable Device** and click **Eject** to uninstall the removable device.

#### CAUTION

Do not remove the removable device without ejecting it during data storing, or the removable device might be damaged.

### 23.4 Wi-Fi Setup\*

\*This function is not applicable to iM50 or iM80.

Before connecting the monitor to a wireless network, you should configure the settings on the monitor following the steps below:

1. Select **Menu > Maintenance > User Maintain**, and input the password **ABC**.
2. In the **User Maintain** menu, select **Network Maintain**.
3. In the **Network Maintain** menu, select **Wireless** from the **Network Type** list. And click **Config** to open the **Wireless Setup** window. The available networks will be listed in this window.
4. Choose a network from the window. You will be prompted to enter the password of that network if a password is required.

If the monitor is successfully connected to the selected network, it will be indicated by the message **Connected**, and the local IP address of the monitor will be displayed in the **Wireless Setup** window. Also, a symbol indicating the networking state will be displayed on the lower portion of the main screen. The meanings of the networking state symbols are explained below:



Wi-Fi disconnected.



Wi-Fi connected. The signal intensity is indicated by the signal bars.



## Chapter 24 Using Battery

### 24.1 Battery Power Indicator

The indicator labeled Battery on the front panel of the monitor illuminates in green when the monitor is battery powered and illuminates in yellow when battery is being charged. The indicator is not illuminated when the monitor is not powered or when AC power is applied.

### 24.2 Battery Status on the Main Screen

Battery status shows the status of each battery detected and the combined battery power remaining, with an estimate of the monitoring time this represents.

There is a sign  in the lower left corner of screen to show the charging status, and the yellow part is the electric energy of battery. When the monitor is not equipped with battery, the battery status will be shown as the sign , which means no battery.

When the monitor is powered by the battery, the monitor will switch off automatically if there is no electric energy in the battery. When there isn't enough electric energy, a sign  is displayed on the screen.

When the monitor is battery powered, the monitor switches off automatically if there is no power.

### 24.3 Checking Battery Performance

The performance of rechargeable batteries may deteriorate over time. Battery maintenance as recommended here can help to slow down this process.

1. Disconnect the patient from the monitor and stop all monitoring and measurement.
2. Switch the monitor power on and charge the battery for more than 6 hours continuously.
3. Disconnect monitor from mains power and let the monitor run until there is no battery power left and the monitor shuts off.
4. The running time of the battery reflects the battery performance.

If the running time is obviously less than the specified time in the specification, please change the battery or contact the service personnel.

---

#### WARNING

- 1 Before using the rechargeable lithium-ion battery (hereinafter called battery), be sure to read the user manual and safety precautions thoroughly.
  - 2 Do not connect the positive (+) and negative (-) terminals with metal objects, and do not put the battery together with metal object, which can result in short circuit.
-



---

**WARNING**

---

- 3 Do not unplug the battery when monitoring.
  - 4 Do not heat or throw battery into a fire.
  - 5 Do not use, leave battery close to fire or other places where temperature may be above 60°C.
  - 6 Do not immerse, throw, or wet battery in water/seawater.
  - 7 Do not destroy the battery: do not pierce battery with a sharp object such as a needle; Do not hit with a hammer, step on or throw or drop to cause strong shock; Do not disassemble or modify the battery.
  - 8 Use the battery only in the monitor. Do not connect battery directly to an electric outlet or cigarette lighter charger.
  - 9 Do not solder the leading wire and the battery terminal directly.
  - 10 If liquid leaking from the battery gets into your eyes, do not rub your eyes. Wash them well with clean water and go to see a doctor immediately. If liquid leaks of the battery splash onto your skin or clothes, wash well with fresh water immediately.
  - 11 Keep away from fire immediately when leakage or foul odor is detected.
  - 12 Stop using the battery if abnormal heat, odor, discoloration, deformation or abnormal condition is detected during use, charge, or storage. Keep it away from the monitor.
  - 13 Do not use a battery with serious scar or deformation.
- 

## 24.4 Replacing the Battery

To install or replace the battery, please follow the procedure:

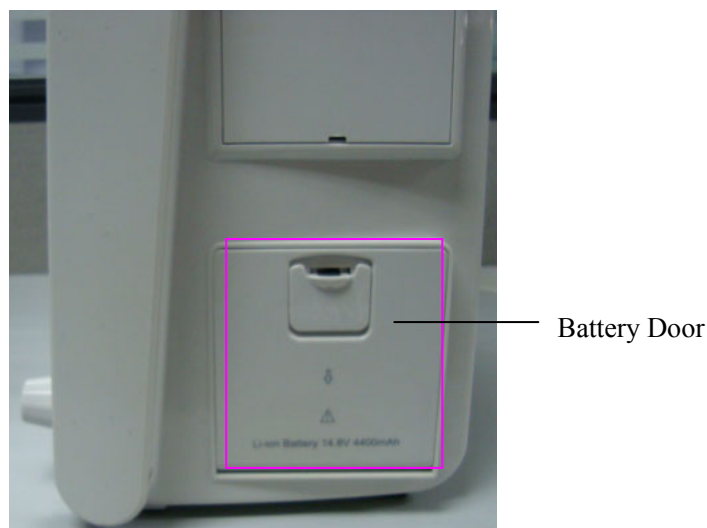

1. Pull the battery door according to indication on it to open it.
2. Pull the plastic retainer until the battery can be removed.

3. Insert the new battery into the battery compartment.
4. Pull the metal retainer downward to fix the battery and close the battery door.

## 24.5 Recycling the Battery

When the battery no longer holds a charge, it should be replaced. Remove the old battery from the monitor and recycle it properly.

**NOTE:**

To prolong the life of rechargeable battery, it is recommended to charge it at least once every month, and it must be done after the electric energy runs out.

## 24.6 Maintaining the Battery

Batteries should be conditioned regularly to maintain their useful life.

Remove the batteries from the monitor if they are not used for a longer period of time. And recharge the batteries at a minimum of every 6 months when they are stored.

Discharge the battery completely once every month.

## Chapter 25 Care and Cleaning

Use only the EDAN-approved substances and methods listed in this chapter to clean or disinfect your equipment. Warranty does not cover damage caused by using unapproved substances or methods.

Edan Instruments has validated the cleaning and disinfection instructions included in this User Manual. It is the responsibility of the healthcare professional to ensure that the instructions are followed so as to ensure adequate cleaning and disinfection

### 25.1 General Points

Keep your monitor, cables and accessories free of dust and dirt. To prevent the device from damage, please follow the procedure:

- Use only recommended cleaning substances and disinfectants listed in this manual. Others may cause damage (not covered by warranty), reduce product lifetime or cause safety hazards.
- Always dilute according to the manufacturer's instructions.
- Unless otherwise specified, do not immerse any part of the equipment or any accessories in liquid.
- Do not pour liquid onto the system.
- Do not allow liquid to enter the case.
- Never use abrasive material (such as steel wool or silver polish).
- Inspect the monitor and reusable accessories after they are cleaned and disinfected.

#### CAUTION

If you spill liquid on the equipment, battery, or accessories, or they are accidentally immersed in liquid, contact your service personnel or EDAN service engineer.

### 25.2 Cleaning

If the device or accessory has been in contact with the patient, then cleaning and disinfection is required after every use. If there has been no patient contact and there is no visible contamination then daily cleaning and disinfection is appropriate.

The validated cleaning agents for cleaning the monitor and reusable accessories are:

- Mild near neutral detergent
- Ethanol (75%)
- Isopropanol (70%)

Cleaning agents should be applied and removed using a clean, soft, non-abrasive cloth or paper towel.

## 25.2.1 Cleaning the Monitor

### **WARNING**

Before cleaning the monitor, make sure that the monitor is switched off and disconnected from the power line.

To surface-clean the monitor, follow these steps:

1. Switch off the monitor and disconnect it from the power line.
2. Wipe the entire exterior surface, including the screen, of the equipment using a soft cloth dampened with the cleaning solution thoroughly until no visible contaminants remain..
3. Wipe off the cleaning solution with a fresh cloth or towel, dampened with tap water after cleaning until no visible cleaning agent remains..
4. Dry the monitor in a ventilated and cool place.

## 25.2.2 Cleaning the Reusable Accessories

### 25.2.2.1 Cleaning the ECG Cable Assembly

1. Wipe the cable assembly with a soft cloth dampened with the cleaning solution until no visible contaminants remain.
2. Wipe off the cleaning solution with a fresh cloth or towel, dampened with tap water after cleaning until no visible cleaning agent remains..
3. Wipe off with a dry cloth to remove residual moisture.
4. Leave the cable assembly to air dry.

### 25.2.2.2 Cleaning the Blood Pressure Cuff

#### **Cleaning the Cuff:**

1. Take out the air bladder before cleaning.
2. Hand wash the cuff with the cleaning solution; clean the air bladder with a soft cloth dampened with the cleaning solution. until no visible contaminants remain
3. Rinse the cuff and wipe off the cleaning solution with a fresh cloth or towel, dampened with tap water after cleaning until no visible cleaning agent remains.
4. Wipe off with a dry cloth to remove residual moisture
5. Air dry the cuff thoroughly after cleaning.

#### **Replacing the Air Bladder:**

After cleaning, replace the air bladder into the cuff following the steps below:

1. Roll the bladder lengthwise and insert it into the cuff from the large opening at one end of the cuff.

2. Thread the hose from within the cuff and out through the small hole at the top of the cuff.
3. Adjust the bladder until it is in position.

### 25.2.2.3 Cleaning the SpO<sub>2</sub> Sensor

1. Wipe the surfaces of the sensor and cable using a soft cloth dampened with the cleaning solution until no visible contaminants remain.
2. Wipe the patient contact area of the sensor with the cotton swab dampened with the cleaning solution. until no visible contaminants remain
3. Wipe off the cleaning solution with a fresh cloth or towel, dampened with tap water after cleaning until no visible cleaning agent remains.
4. Wipe off with a dry cloth to remove residual moisture.
5. Leave the sensor to air dry.

### 25.2.2.4 Cleaning the IBP/C.O. Cables

1. Wipe the cables with a soft cloth dampened with the cleaning solution until no visible contaminants remain.
2. Wipe off the cleaning solution with a fresh cloth or towel, dampened with tap water after cleaning until no visible cleaning agent remains.
3. Wipe off with a dry cloth to remove residual moisture.
4. Leave the cables to air dry.

### 25.2.2.5 Cleaning the TEMP Sensor/Quick TEMP Probe

1. Wipe the patient contact area with a soft cloth dampened with the cleaning solution until no visible contaminants remain.
2. Wipe off the cleaning solution with a fresh cloth or towel, dampened with tap water after cleaning until no visible cleaning agent remains.
3. Wipe off with a dry cloth to remove residual moisture.
4. Leave the sensor/probe to air dry.

## 25.3 Disinfection

For devices or accessories that have been in contact mucosal surface, High Level disinfection must occur, for all other accessories, low level disinfection is appropriate. Clean the monitor and reusable accessories before they are disinfected. The validated disinfectants for cleaning the monitor and reusable accessories are:

- Ethanol (75%)
- Isopropanol (70%)
- Cidex OPA (High level disinfection of intracavitary temperature probe only)

If Ethanol or Isopropanol is used for both cleaning and disinfecting, then a new cloth is required

to be used for the disinfection step.

---

---

**WARNING**

The monitor and reusable accessories shall be disinfected to avoid patient cross infection.

---

---

### 25.3.1 Disinfecting the Monitor

---

---

**WARNING**

Before disinfecting the monitor, make sure that the monitor is switched off and disconnected from the power line.

---

---

To disinfect the monitor, follow these steps:

1. Switch off the monitor and disconnect it from the power line.
2. Wipe the display screen using a soft, clean cloth dampened with the disinfectant solution.
3. Wipe the exterior surface of the equipment using a soft cloth dampened with the disinfectant solution.
4. Wipe off the disinfectant solution with a dry cloth after disinfection if necessary.
5. Dry the monitor for at least 30 minutes in a ventilated and cool place.

### 25.3.2 Disinfecting the Reusable Accessories

#### 25.3.2.1 Disinfecting the ECG Cable Assembly

1. Wipe the cable assembly with a soft cloth dampened with the disinfectant solution.
2. Wipe off the disinfectant solution with a dry cloth after disinfection.
3. Leave the cable assembly to air dry for at least 30 minutes.

#### 25.3.2.2 Disinfecting the Blood Pressure Cuff

**Disinfecting the Cuff:**

1. Take out the air bladder before disinfection.
2. Wipe the cuff and the air bladder with a soft cloth dampened with the disinfectant solution.
3. Leave the cuff and air bladder to air dry for at least 30 minutes.

**Replacing the Air Bladder:**

After disinfection, replace the air bladder into the cuff. Refer to Section 25.2.2.2 for more information.

**NOTE:**

Prolonged use of disinfectant may cause discoloration of the cuff.

### 25.3.2.3 Disinfecting the SpO<sub>2</sub> Sensor

1. Wipe the surfaces of the sensor and cable using a soft cloth dampened with the disinfection solution.
2. Wipe the patient contact area of the sensor with the cotton swab dampened with the disinfection solution.
3. Wipe off the disinfection solution with a dry cloth after disinfection.
4. Leave the sensor to air dry for at least 30 minutes.

### 25.3.2.4 Disinfecting the IBP/C.O. Cables

1. Wipe the cables with a soft cloth dampened with the disinfectant solution.
2. Wipe off the disinfectant solution with a dry cloth after disinfection.
3. Leave the cables to air dry for at least 30 minutes.

### 25.3.2.5 Disinfecting the TEMP sensor

The intracavitary TEMP sensors should be reprocessed by high-level disinfection before and after use on each new patient. Cidex OPA is the validated agent for high level disinfection. Refer to the instructions of the disinfectant for the methods of disinfection. High level disinfection has been validated with a 12 minute soak. Rinse and dry according to the labeled instructions of Cidex OPA. Do not dampen the sensor connector.

For the skin TEMP sensors, disinfect them as follows using ethanol or isopropanol only:

1. Wipe the patient contact area with a soft cloth dampened with the disinfectant solution (ethanol or isopropanol).
2. Wipe off the disinfectant solution with a dry cloth after disinfection.
3. Leave the sensor to air dry.

## 25.4 Cleaning and Disinfecting Other Accessories

For cleaning and disinfecting other accessories, refer to the instructions delivered with the accessories. If the accessories are not accompanied by instructions, refer to this manual for the methods of cleaning and disinfecting the monitor.

## Chapter 26 Maintenance

### WARNING

- 1 Failure on the part of the responsible individual hospital or institution employing the use of this equipment to implement a satisfactory maintenance schedule may cause undue equipment failure and possible health hazards.
- 2 If you discover a problem with any of the equipment, contact your service personnel, or your authorized supplier.

### 26.1 Inspecting

The overall check of the monitor, including the safety check, should be performed only by qualified personnel every 24 months, and each time after fix up.

The following items should be checked:

- If the environment condition and power supply meet requirement.
- If the power supply cord has damage and insulativity meets requirement.
- If the device and accessories have damage.
- Specified accessories.
- If the alarm system can work properly.
- If the recorder can work properly and the paper meets the requirement.
- Battery performance
- If all monitoring functions are in good conditions.
- If the grounding resistance and leakage current meet requirement.

If any damage or abnormality is found, please don't use the monitor and contact local Customer Service Center.

### 26.2 Maintenance Task and Test Schedule

The following tasks are for EDAN-qualified service professionals only. Contact an EDAN-qualified service provider if your monitor needs a safety or performance test. Clean and disinfect equipment to decontaminate it before testing or maintaining it.

Maintenance and Test Schedule	Frequency
Safety checks. Selected tests on the basis of IEC60601-1	At least once every two years, or as needed, after any repairs where the power supply is removed or replaced, or if the monitor has been dropped.
Check ECG synchronization of the monitor and defibrillator	At least once every two years, or as needed.



NIBP Leakage Inspection	At least once every two years, or as specified by local laws.
NIBP Pressure Calibration	At least once every two years, or as specified by local laws.
NIBP Calibration	At least once every two years, or as specified by local laws.
AG Calibration	If you suspect the measurement values are incorrect and need to calibrate, please contact the manufacturer.

## Chapter 27 Warranty and Service

### 27.1 Warranty

EDAN warrants that EDAN's products meet the labeled specifications of the products and will be free from defects in materials and workmanship that occur within warranty period.

The warranty is void in cases of:

- a) damage caused by mishandling during shipping.
- b) subsequent damage caused by improper use or maintenance.
- c) damage caused by alteration or repair by anyone not authorized by EDAN.
- d) damage caused by accidents.
- e) replacement or removal of serial number label and manufacture label.

If a product covered by this warranty is determined to be defective because of defective materials, components, or workmanship, and the warranty claim is made within the warranty period, EDAN will, at its discretion, repair or replace the defective part(s) free of charge. EDAN will not provide a substitute product for use when the defective product is being repaired.

### 27.2 Contact information

If you have any question about maintenance, technical specifications or malfunctions of devices, contact your local distributor.

Alternatively, you can send an email to EDAN service department at: [support@edan.com.cn](mailto:support@edan.com.cn).

## Chapter 28 Accessories

You can order accessories from EDAN supplies at [www.edan.com.cn](http://www.edan.com.cn) or consult your local EDAN representative for details.

### WARNING

- 1 Never reuse disposable transducers, sensors, accessories and so forth that are intended for single use, or single patient use only. Reuse may compromise device functionality and system performance and cause a potential hazard.
- 2 Use only EDAN-approved accessories. Using non-EDAN-approved accessories may compromise device functionality and system performance and cause a potential hazard.
- 3 Do not use a sterilized accessory if its packaging is damaged.

### NOTE:

Transducers and sensors have a limited shelf life. Refer to the package labeling.

The following cables may not all be available in all countries. Please check availability with your local EDAN supplier.

### 28.1 ECG Accessories

The following table lists the optional configuration for the monitor:

Part Number	Accessories
01.57.471230	ECG trunk cable, 5-lead, 6pin, ESU, AHA/IEC, 2.7m, reusable
01.57.471231	ECG trunk cable, 5-lead, 6pin, ESU, AHA/IEC, 5.0m, reusable
01.57.471232	ECG trunk cable, 5-lead, 6pin, defibrillator-proof, AHA/IEC, 2.7m, reusable
01.57.471233	ECG trunk cable, 5-lead, 6pin, defibrillator-proof, AHA/IEC, 5.0m, reusable
01.13.036620	ECG limb wires, 5-lead, clip, AHA, 1.0m&1.6m, reusable
01.13.036621	ECG limb wires, 5-lead, clip, AHA, 1.0m, reusable
01.13.036622	ECG limb wires, 5-lead, snap, AHA, 1.0&1.6m, reusable
01.13.036623	ECG limb wires, 5-lead, snap, AHA, 1.0m, reusable
01.13.036624	ECG limb wires, 5-lead, clip, IEC, 1.0m&1.6m, reusable
01.13.036625	ECG limb wires, 5-lead, clip, IEC, 1.0m, reusable
01.13.036626	ECG limb wires, 5-lead, snap, IEC, 1.0&1.6m, reusable

<b>Part Number</b>	<b>Accessories</b>
01.13.036627	ECG limb wires, 5-lead, snap, IEC, 1.0m, reusable
01.57.471024	3-lead ECG trunk cable, Defibrillator-proof, AHA/IEC
01.57.471025	3-lead clip ECG limb wires, IEC
01.57.471165	3-lead ,clip, ECG limb cable, AHA
01.57.040202	ECG trunk cable, 10-lead, defibrillator-proof, IEC, 2.6m, reusable (Only applicable to iM80)
01.57.040203	ECG limb wires, 10-lead, snap, IEC, 0.9m, reusable (Only applicable to iM80)
01.57.109100	ECG trunk cable, 10-lead, defibrillator-proof, AHA, 2.6m, reusable (Only applicable to iM80)
01.57.109101	ECG limb wires, 10-lead, snap, AHA, 0.9m, reusable (Only applicable to iM80)
01.57.471095	ECG Cable, 3 lead, snap, defibrillator-proof, AHA, 3.5m, reusable
01.57.471087	ECG Cable, 3 lead, clip, defibrillator-proof, AHA, 3.5m, reusable
01.57.471096	ECG Cable, 5 lead, snap, defibrillator-proof, AHA, 3.5m, reusable
01.57.471097	ECG Cable, 5 lead, clip, defibrillator-proof, AHA, 3.5m, reusable
01.57.471098	ECG Cable, 3 lead, snap, defibrillator-proof, IEC, 3.5m, reusable
01.57.471099	ECG Cable, 3 lead, clip, defibrillator-proof, IEC, 3.5m, reusable
01.57.471089	ECG Cable, 5 lead, snap, defibrillator-proof, IEC, 3.5m, reusable
01.57.471088	ECG Cable, 5 lead, clip, defibrillator-proof, IEC, 3.5m, reusable
01.57.471196	ECG limb cable, 3-lead, snap, AHA, 0.63m, DIN, reusable
01.57.471198	ECG limb cable, 3-lead, clip, AHA, 0.63m, DIN, reusable
01.57.471195	ECG limb cable, 3-lead, snap, IEC, 0.63m, DIN, reusable
01.57.471197	ECG limb cable, 3-lead, clip, IEC, 0.63m, DIN, reusable
01.57.471193	ECG trunk cable, 3-lead, 6pin, defibrillator-proof, AHA/IEC, 2.9m, DIN, reusable
01.57.471276	ECG conductive adhesive electrodes, TYCO KENKALL MEDI TRACE 210, 10PCS/package
11.57.471056	Adult disposable adhesive electrodes, TYCO H99SG, 30PCS/package, CE

Part Number	Accessories
11.57.471060	Adult disposable adhesive electrodes, TYCO Medi-Trace 200, 100PCS/package, FDA
11.57.471057	Children/Neonatal disposable adhesive electrodes, TYCO H124SG, 50PCS/package, CE

## 28.2 SpO<sub>2</sub> Accessories

Part Number	Accessories
<b>For EDAN Module</b>	
02.01.210119	EDAN SH1 Adult Reusable SpO <sub>2</sub> Sensor (Lemo) (Only compatible with EDAN SpO <sub>2</sub> module), 2.5 m (finger type, for patients more than 40kg)
02.01.210120	EDAN SH1 Adult Reusable SpO <sub>2</sub> Sensor (DB9) (Only compatible with EDAN SpO <sub>2</sub> module and EDAN SpO <sub>2</sub> Extension cable ), 1m (finger type, for patients more than 40kg)
12.01.110492	EDAN SH3 Neonate Warp SpO <sub>2</sub> Sensor (DB9) (Only compatible with EDAN SpO <sub>2</sub> module and EDAN SpO <sub>2</sub> Extension cable),1m (hand or foot, for patients less than 3kg)
02.01.210122	EDAN SH4 Adult Silicone Soft-tip SpO <sub>2</sub> Sensor (DB9) (Immersion Disinfection) (Only compatible with EDAN SpO <sub>2</sub> module and EDAN SpO <sub>2</sub> Extension cable), 1m (finger type, for patients more than 50kg)
02.01.210121	EDAN SH5 pediatric Silicone Soft-tip SpO <sub>2</sub> Sensor ( DB9) (Only compatible with EDAN SpO <sub>2</sub> module and EDAN SpO <sub>2</sub> Extension cable), 1m (finger type, for patients between 10kg to 50kg)
01.13.210001	EDAN SpO <sub>2</sub> Extension cable(DB9 to Lemo, 2m, TPU)
01.57.040196	Adult disposable SpO <sub>2</sub> sensor(Only applicable to iM50 and iM80)
01.57.040197	Pediatric Disposable SpO <sub>2</sub> sensor(Only applicable to iM50 and iM80)
01.57.040198	Infant Disposable SpO <sub>2</sub> sensor(Only applicable to iM50 and iM80)
01.57.040199	Neonatal Disposable SpO <sub>2</sub> Sensor(Only applicable to iM50 and iM80)
<b>For Nellcor Module</b>	
11.15.30043	Nellcor Reusable Adult SpO <sub>2</sub> Sensor (DS-100A OxiMax) (forefinger, for patient over 30kg)

<b>Part Number</b>	<b>Accessories</b>
11.15.40096	Nellcor Reusable Adult/Neonate SpO2 Sensor (OXI-A/N OxiMax) (forefinger or foot)
11.13.30131	Nellcor SpO2 Extension cable (Compatible with Nellcor OXI-Max SpO2 module and Nellcor sensor)

### 28.3 NIBP Accessories

<b>Part Number</b>	<b>Accessories</b>
<b>For EDAN Module</b>	
01.57.471326	EDAN Reusable Blood Pressure Cuff Infant E5
01.57.471327	EDAN Reusable Blood Pressure Cuff Small Child E6
01.57.471328	EDAN Reusable Blood Pressure Cuff Child E7
01.57.471329	EDAN Reusable Blood Pressure Cuff Small Adult E8
01.57.471330	EDAN Reusable Blood Pressure Cuff Adult E9
01.57.471331	EDAN Reusable Blood Pressure Cuff Large Adult E10
01.57.471005	NIBP Tube (3m) with connector
01.57.471323	NIBP Cuff, Neonate, 10cm-15cm, reusable
01.57.471324	NIBP Cuff, Neonate, 6cm-11cm, reusable
11.57.40097	Neonatal Cuff 5102 (About 5.4-9.1cm), for single patient use
11.57.40098	Neonatal Cuff 5104 (About 6.9-11.7cm), for single patient use
01.57.471157	NIBP Cuff, neonatal #1, 3-6cm, for single patient use
01.57.471158	NIBP Cuff, neonatal #2, 4-8cm, for single patient use
01.57.471159	NIBP Cuff, neonatal #3, 6-11cm, for single patient use
01.57.471160	NIBP Cuff, neonatal #4, 7-13cm, for single patient use
01.57.471161	NIBP Cuff, neonatal #5, 8-15cm, for single patient use
01.57.471021	Connecting Tube for Neonatal Cuff (Only compatible with Neonatal Disposable and NIBP Tube)

<b>Part Number</b>	<b>Accessories</b>
01.57.471303	NIBP spiral Tube with connector
01.57.471291	NIBP Tube (3m) with RECTUS quick connector
<b>For Omron Module</b>	
01.59.102099	OMRON NIBP Tube (3.5m) /CUFF HOSE (NO.1) length3.5m, CE (Only applicable to iM80 and iM70)
01.57.471078	OMRON CUFF/CUFF (NO.1) arm12—18cm, width7cm, LATEX, CE (Only applicable to iM80 and iM70)
01.57.471079	OMRON CUFF/CUFF (NO.2) arm17—23cm, width9cm, LATEX, CE (Only applicable to iM80 and iM70)
01.57.102100	OMRON CUFF/CUFF (NO.3) arm23—33cm, width12cm, LATEX, CE (Only applicable to iM80 and iM70)
01.57.471080	OMRON CUFF/CUFF (NO.4) arm30—40cm, width14cm, LATEX, CE (Only applicable to iM80 and iM70)
01.57.471081	OMRON Neonatal disposable cuff/CUFF (NO.10) arm3.5—6cm, width2.5cm, CE (Only applicable to iM80 and iM70)
01.57.471082	OMRON Neonatal disposable cuff/CUFF (NO.11) arm5—7.5cm, width3cm, CE (Only applicable to iM80 and iM70)
01.57.471083	OMRON Neonatal disposable cuff/CUFF (NO.12) arm7.5—10.5cm, width4cm, CE (Only applicable to iM80 and iM70)
01.57.471084	OMRON Neonatal disposable cuff/CUFF (NO.13) arm8.5—13cm, width5cm, CE (Only applicable to iM80 and iM70)
01.59.473003	Connecting Tube for Neonatal Cuff (Only compatible with Neonatal Disposable and NIBP Tube)/CUFF HOSE (NO.3) length3.5m, CE (Only applicable to iM80 and iM70)

## 28.4 Temp Accessories

<b>Part Number</b>	<b>Accessories</b>
01.15.040257	Neonatal/pediatric Skin Temperature Probe (2.252K)
01.15.040258	Neonatal/pediatric Intracavitary Temperature Probe (2.252K)
01.15.040259	Neonatal/pediatric Skin Temperature Probe (10K)
01.15.040260	Neonatal/pediatric Intracavitary Temperature Probe (10K)

Part Number	Accessories
01.15.040185	Skin Temperature Probe (2.252K)
01.15.040187	Skin Temperature Probe (10K)
01.15.040184	Intracavitary Temperature Probe (2.252K)
01.15.040186	Intracavitary Temperature Probe (10K)

## 28.5 Quick Temp Accessories\*

Part Number	Accessories
02.04.110140	Oral/Auxiliary Probe
02.04.110139	Rectal Probe
11.57.110159	Probe Covers

\* Only applicable to iM50

\* Not available in the U.S.A., Canada, UK and Germany

## 28.6 IBP Accessories

Part Number	Accessories
01.57.471280	6Pin ICP Transducer Interface cable (compatible with Gaeltec ICT/B Intracranial Pressure Transducer)
01.57.471014	Pressure transducer interface cable, BD
01.57.471013	Pressure transducer interface cable, EDWARD
01.57.471027	Pressure transducer interface cable, HOSPIRA
01.57.471028	Pressure transducer interface cable, UTAH
11.57.40121	Disposable pressure transducer kit (BD DTX TM Plus DT-4812 682000)

## 28.7 CO<sub>2</sub> Accessories

Part Number	Accessories
<b>For EDAN Module</b>	
02.01.210520	Dewatering Cup(Single Patient Use, Adult/Pediatric 10ml)
01.57.471275	CO2 Sampling Line with Male Luer Lock, 2.0m



<b>Part Number</b>	<b>Accessories</b>
01.57.471282	All Purpose Sampling Cannula without filter (Non Sterile). Size: Adult
01.57.471283	All Purpose Sampling Cannula without filter (Non Sterile). Size: Infant
01.57.471284	All Purpose Sampling Cannula without filter (Non Sterile). Size: Neonate
01.57.471285	Duo Flow O2+CO2 Sampling Cannula (Non Sterile). Size: Adult
01.57.471286	Duo Flow O2+CO2 Sampling Cannula (Non Sterile). Size: Child
01.57.471287	Capnomask O2+CO2 Sampling Cannula (Non Sterile). Size: Adult
01.57.471288	Capnomask O2+CO2 Sampling Cannula (Non Sterile). Size: Child
<b>For Respironics Module</b>	
12.08.078137	Respironics EtCO2 module/(Side-stream) 1022054
11.15.040143	Respironics CAPNOSTAT 5 EtCO2 (Main-stream) Module 1015928
12.08.078166	LoFlo™ Module Mounting Bracket(Respironics 1027730)
11.57.078139	Disposable CO2 Nasal Cannula - Adult (Respironics 3468ADU-00)
11.57.078151	Adult/Pediatric Airway adapter kit with dehumidification tubing
11.57.078154	Disposable Sampling Line Kit with Dehumidification Tubing (Respironics 3475-00)
11.57.471019	Reuseable Adult/Pediatric Airway Adapter (7007-01)
11.57.471020	Reuseable Neonate/Infant Airway Adapter (7053-01)
11.59.078155	Disposable Adult Airway Adapter (6063-00)
11.59.078156	Disposable Neonatal( infant/pediatric) Airway Adapter (6312-00)
11.57.078142	Adult Nasal CO2 with O2 delivery sampling cannula
11.57.078143	Pediatric Nasal CO2 with O2 delivery sampling cannula
11.57.078144	Infant Nasal CO2 with O2 delivery sampling cannula
11.57.101019	Adult Nasal/Oral CO2 sampling cannula
11.57.101020	Pediatric Nasal/Oral CO2 sampling cannula
11.57.101021	Adult Nasal/Oral CO2 with O2 delivery sampling cannula
01.12.031598	Adult/Pediatric Airway adapter kit
11.57.078140	Disposable CO2 Nasal Cannula - Pediatric (Respironics 3468PED-00)
11.57.078141	Disposable CO2 Nasal Cannula - Infant (Respironics 3468INF-00)
11.57.078152	Pediatric/Infant Airway adapter kit with dehumidification tubing
11.57.078158	Pediatric mask/mainstream 9960PED-00

Part Number	Accessories
11.57.078159	Adult standard mask /mainstream 9960STD-00
11.57.078160	Adult large mask /mainstream 9960STD-00
11.57.078161	Band/mainstream 8751-00
11.12.078162	bayonet socket

## 28.8 C.O. Accessories\*

Part Number	Accessories
01.57.471012	Cardiac output cable
11.13.40119	In-line Injection temperature probe (BD 684056-SP4042)
11.57.40120	In-line Injection temperature probe housing (BD 680006-SP5045)
11.57.100175	Control Syringe (Medex MA387)

\*Not applicable to iM50

The Thermodilution Catheter is required when measuring C.O. Swan-Ganz catheter (Type 131HF7), manufactured by Edwards Lifesciences Corporation, has been validated to be compatible with the monitor. Refer to Edwards for more details.

## 28.9 AG Accessories\*

Part Number	Accessories
11.57.471043	Nomoline with Luer Lock connector, Box of 25CAT.NO. 108210
11.57.471042	IRMA Airway AdapterAdult/Pediatric, Box of 25CAT.NO. 106220
01.57.471189	Nomoline Adapter, Cat no: 108220, Sampling line with female luer lock connector.Adult/Pediatric/Infant, 0.15 m
01.57.471190	Nomoline Airway Adapter Set, Cat no: 108230, Sampling line with straight airway adapter, single-patient use, Adult/Pediatric, 2.0 m
01.57.471191	Nomo Extension, Cat no: 108240, Sampling line with male luer lock connector, 2.0 m
01.57.471192	T-adapter, Cat no: 108250, Airway adapter with female luer lock connector, Adult/Pediatric

\* Only applicable to iM70 and iM80

## 28.10 Other Accessories

<b>Part Number</b>	<b>Accessories</b>
11.57.471048	Assembly board for iM80 gas module
11.21.064143	Rechargeable Lithium-Ion Battery, 14.8V, 4.2Ah
02.01.210217	EPRT-48mm recorder, Serial/parallel port
12.01.19084	Thermal printer
02.01.109592	Pole clamp, 1 set /package
02.01.109636	Pole clamp, 4 sets/package
01.57.78035	Recorder paper
01.18.052268	Netac USB Flash Drive (U208, 8G)
11.23.068003	USB barcode scanner
02.01.210080	Wall mounting assembly
02.01.210173	Wall mounting assembly, no basket
02.01.101043	Basket (Only compatible with Wall Mount MS3R-30164)
11.18.078205	Security lock
02.01.101985	MT206 trolley assembly for iM50, no plug board
02.01.101986	MT207 trolley assembly for iM80, no plug board
02.04.101978	Trolley plug board assembly kit
11.13.01950	Three flat power cable, length 3 m
01.13.36014	Power cable, length 1.8 m, VDE
11.13.36015	Power cable, length 1.8 m, American standard
01.13.036106	Power cable, length 1.8 m, American standard, medical grade
11.13.114214	Ground Cable
02.01.210633	Recorder
01.18.052307	Sandisk SD Card (CLASS 4, 8G)

## A Product Specification

### A.1 Classification

Anti-electroshock type	Class I equipment and internal powered equipment
Anti-electroshock degree	ECG (RESP), TEMP, IBP, C.O., Quick Temp CF SpO <sub>2</sub> , NIBP, CO <sub>2</sub> , AG BF
Ingress Protection	IPX1 (No protection against ingress of water if configured with Quick TEMP module)
Disinfection/sterilization method	Refer to Chapter Care and Cleaning for details.
Working system	Continuous operation equipment
Compliant with Standards	IEC 60601-1: 1988+A1: 1991+A2: 1995; EN 60601-1: 1990+A1: 1993+A2: 1995; IEC 60601-1-2: 2001+A1: 2004; EN 60601-1-2: 2001+A1: 2006; ISO 9919, ISO 21647, IEC/EN 60601-2-27, IEC/EN 60601-2-30, IEC/EN 60601-2-34, IEC/EN 60601-2-49, ANSI/AAMI SP10, AAMI/ANSI EC13, EN12470-4 EN1060-1 EN1060-3, EN1060-4, IEC/EN 60601-2-25*, IEC/EN 60601-2-51* (Symbol * means this standard only applicable to iM80)

### A.2 Physical Specifications

#### A.2.1 Size and Weight

Product	Size	Weight (standard configuration, without battery)
iM50	261 mm (L) × 198 mm (W) × 215 mm (H)	<3.6 kg
iM60	303mm(L) × 161mm(W) × 254mm(H)	<4.5 kg
iM70	328mm(L) × 158mm(W) × 285mm(H)	<5.5 kg
iM80	370 mm (L) × 175 mm (W) × 320 mm (H)	<7 kg

#### A.2.2 Environment Specification

The monitor may not meet the performance specifications given here if stored or used outside the specified temperature and humidity ranges.

When the monitor and related products have differing environmental specifications, the effective range for the combined products is that range which is common to the specifications for all products.

Temperature		
Working	+5°C ~ +40°C	
Transport and Storage	-20°C ~ +55°C	
Humidity		
Working	25% ~ 80% (non-condensing)	
Transport and Storage	25% ~ 93% (non-condensing)	
Altitude		
Working	860hPa ~ 1060hPa	
Transport and Storage	700hPa ~ 1060hPa	
Power Supply	100V-240V~, 50Hz/60Hz	
	iM50	Current=1.0A-0.5A; Fuse: T 1.6AL, 250V
	iM80	Current=1.4A-0.7A; Fuse: T 1.6AL, 250V
	iM60/iM70	Current=1.4A-0.7A; Fuse: T3.15AH, 250V

### A.2.3 Display

Product	Display	Messages
iM50	Display screen: 8.4 inch color TFT, supporting touch screen Resolution: 800×600	A maximum of 11 waveforms One power LED Two alarm LED One charge LED
iM60	Display screen: 10.4 inch color TFT, supporting touch screen Resolution: 800×600	A maximum of 11 waveforms One power LED Two alarm LED One charge LED
iM70	Display screen: 12.1 inch color TFT, supporting touch screen Resolution: 800×600	A maximum of 11 waveforms One power LED Two alarm LED One charge LED

iM80	Display screen: 15 inch color TFT, supporting touch screen Resolution: 1024 × 768	A maximum of 13 waveforms One power LED Two alarm LED One charge LED
------	--------------------------------------------------------------------------------------	-------------------------------------------------------------------------------

### A.2.4 Battery Specification

Operating Time	iM50	2.1Ah	180 min or longer
		4.2Ah	420 min or longer
	iM80	One battery (4.2Ah)	120 min or longer
		Two batteries (2*4.2Ah)	240 min or longer
	iM60/iM70	2.1Ah	150 min or longer
		4.2Ah	300 min or longer
Condition	At 25°C, with (a) new fully charged battery/batteries, continuous SpO <sub>2</sub> measurement and NIBP automatic measurement mode at interval of 15 minutes, ECG/TEMP module connected, recording at interval of 10 minutes, brightness set to “1”		
Charge Time	iM50	2.1Ah	200 min or shorter
		4.2Ah	380 min or shorter
	iM80	One battery (4.2Ah)	320 min or shorter
		Two batteries (2*4.2Ah)	560 min or shorter
	iM60/iM70	2.1Ah	200 min or shorter
		4.2Ah	360 min or shorter
Condition	Monitor is on or in standby mode.		

### A.2.5 Recorder

Record Width	48 mm
Paper Speed	25 mm/s, 50 mm/s
Trace	3
Recording types	Continuous real-time recording 8 seconds real-time recording Time recording

	Alarm recording Trend graph recording Trend table recording NIBP review recording Arrhythmia review recording Alarm review recording Drug calculation titration recording Hemodynamic Calculation result recording 12-lead analysis recording C.O. measurement recording
--	-----------------------------------------------------------------------------------------------------------------------------------------------------------------------------------------------------------------------------------------------------------------------------------------------------

### A.2.6 Data Storage

Trend graph/trend table review	1 hour, at 1 Second Resolution by default 120 hrs, at 1 min. Resolution by default
Alarm/Monitoring Event data	Up to 60 sets
NIBP Measurement Review	1200 sets
Arrhythmia events	Up to 60 sets
12-lead Diagnosis Review	Up to 50 sets

### A.3 Wi-Fi\*

IEEE	802.11b/g/n
Frequency Band	2.400 – 2.500 GHz (2.4 GHz ISM band)
Modulation	OFDM with BPSK, QPSK, 16-QAM, and 64-QAM 802.11b with CCK and DSSS
Typical Transmit Power ( $\pm 2$ dBm)	17 dBm for 802.11b DSSS 17 dBm for 802.11b CCK 15 dBm for 802.11g/n OFDM

\*Not applicable to iM50 or iM80.

## A.4 ECG

Lead Mode	3-Lead: I, II, III 5-Lead: I, II, III, aVR, aVL, aVF, V 12-Lead: I, II, III, aVR, aVL, aVF, V1, V2, V3, V4, V5, V6
Waveform	3-Lead: 1-channel waveform; 5-Lead: 2-channel waveform, max. seven waveforms; 12-Lead: 2-channel waveform, a maximum of 13 waveforms;
Lead naming style	AHA, IEC
Display Sensitivity	1.25mm/mV ( $\times 0.125$ ), 2.5mm/mV ( $\times 0.25$ ), 5mm/mV ( $\times 0.5$ ), 10mm/mV ( $\times 1$ ), 20mm/mV ( $\times 2$ ), 40mm/mV ( $\times 4$ ), AUTO gain
Waveform Speed	6.25mm/s, 12.5mm/s, 25mm/s, 50mm/s
Bandwidth (-3dB)	Diagnosis: 0.05Hz to 150Hz Monitor: 0.5Hz to 40Hz Surgery: 1Hz to 20Hz
CMRR (Common Mode Rejection Ratio)	Diagnosis: >95dB (the Notch filter is off) Monitor: >105dB (the Notch filter is on) Surgery: >105dB (the Notch filter is on)
Notch	In diagnosis, monitoring, surgery mode: 50Hz/60Hz (Notch filter can be turned on or off manually)
Differential Input Impedance	>5M $\Omega$
Input Signal Range	$\pm 10$ mV (peak-to-peak value)
Accuracy of Input Signal Reconstruction	The total error and frequency response comply with ANSI/AAMI EC13:2002, Sect. 4.2.9.8.
Electrode Offset Potential Tolerance	$\pm 500$ mV
Auxiliary Current (Leads off detection)	Active electrode: <100nA Reference electrode: <900nA
Recovery time after Defibrillation	<5s
Leakage current of patient	<10 $\mu$ A



Scale signal	1mV(peak-to-peak value), accuracy is $\pm 5\%$
System noise	$<30\mu\text{VPP}$
ESU Protection	Recovery time: $\leq 10\text{s}$
Pace Pulse	
Pulse indicator	Pulse is marked if the requirements of ANSI/AAMI EC13:2002, Sect. 4.1.4.1 are met: Amplitude: $\pm 2\text{ mV} \sim \pm 700\text{ mV}$ Width: $0.1\text{ ms} \sim 2\text{ ms}$ Ascending time: $10\ \mu\text{s} \sim 100\ \mu\text{s}$
Pulse Rejection	Pulse is rejected if the requirements of ANSI/AAMI EC13:2002, Sect. 4.1.4.1 are met: Amplitude: $\pm 2\text{ mV} \sim \pm 700\text{ mV}$ Width: $0.1\text{ ms} \sim 2\text{ ms}$ Ascending time: $10\ \mu\text{s} \sim 100\ \mu\text{s}$
Minimum input slew rate	$>2.5\text{V/S}$
Heart rate	
Measurement Range	ADU: $15\text{ bpm} \sim 300\text{ bpm}$ PED/NEO: $15\text{ bpm} \sim 350\text{ bpm}$
Accuracy	$\pm 1\%$ or $\pm 1\text{ bpm}$ , whichever is greater
Resolution	1 bpm
PVC	
Measurement Range	ADU: $0\sim 300\text{ PVCs/ min}$ PED/NEO: $0\sim 350\text{ PVCs/ min}$
Resolution	1 PVCs/min
ST value(only applicable to adult)	
Measurement Range	$-2.0\text{ mV} \sim +2.0\text{ mV}$
Accuracy	$-0.8\text{ mV} \sim +0.8\text{ mV}$ : $\pm 0.02\text{ mV}$ or $10\%$ ( $\sigma$ ), whichever is greater. Beyond this range: undefined
Resolution	0.01 mV
HR averaging method	

Method 1	Heart rate is computed by excluding the minimum and maximum values from the 12 most recent RR intervals and averaging the residual 10 RR intervals.
Method 2	If each of three consecutive RR intervals is greater than 1200ms, then the four most recent RR intervals are averaged to compute the HR.
Range of Sinus and SV Rhythm	
Tachy	ADU: 120 bpm ~ 300 bpm PED/NEO: 160 bpm ~ 350 bpm
Normal	ADU: 41 bpm ~ 119 bpm PED/NEO: 61 bpm ~159 bpm
Brady	ADU: 15 bpm ~ 40 bpm PED/NEO: 15 bpm ~ 60 bpm
Range of Ventricular Rhythm	
Ventricular Tachycardia	The interval of 5 consecutive ventricular beats is less than 600 ms
Ventricular Rhythm	The interval of 5 consecutive ventricular beats ranges from 600 ms to 1000 ms
Ventricular Bradycardia	The interval of 5 consecutive ventricular beats is more than 1000 ms
Maximum Start-up alarm time for Tachycardia	
Ventricular Tachycardia 1 mV 206bpm	Gain 1.0: 10 s Gain 0.5: 10 s Gain 2.0: 10 s
Ventricular Tachycardia 2 mV 195bpm	Gain 1.0: 10 s Gain 0.5: 10 s Gain 2.0: 10 s
Response time of Heart Rate Meter to Change in HR	HR range: 80 bpm ~ 120 bpm Range : 7s ~ 8s, average is 7.5s HR range: 80bpm ~ 40bpm Range : 7s ~ 8s, average is 7.5s
Tall T-wave Rejection	Complies with ANSI/AAMI EC13: 2002 Sect. 4.1.2.1 C) minimum recommended 1.2mV T-Wave amplitude

Accuracy of Heart Rate Meter and Response to Irregular Rhythm	Complies with ANSI/AAMI EC13: 2002 Sect.4.1.2.1 e) The HR value displays after a stable period of 20s: Ventricular bigeminy: 80bpm±1bpm Slow alternating ventricular bigeminy: 60bpm±1bpm Rapid alternating ventricular bigeminy: 120bpm±1bpm Bidirectional systoles: 91bpm±1bpm		
16 different arrhythmia analysis classification (applicable to adult and pediatric)	ASYSTOLE	VFIB/VTAC	COUPLET
	VT>2	BIGEMINY	TRIGEMINY
	VENT	R on T	PVC
	TACHY	BRADY	MISSED BEATS
	IRR	VBRADY	PNC
	PNP		
12-lead ECG Synchronization Analysis	Average parameters of heart beat		
	Heart rate (bpm)		
	Time limit of P wave (ms)		
	PR interval (ms)		
	QRS interval (ms)		
	QT/QTc (ms)		
	P-QRS-T AXIS		
ECG Analog Output			
Bandwidth (-3dB; reference frequency: 10Hz)	Diagnosis: 0.05Hz ~ 100Hz Monitor: 0.5Hz ~ 40Hz Surgery: 1Hz ~ 20Hz		
Maximum transmission delay	500ms (in diagnostic mode, and with notch off)		
Sensitivity	1V/mV ±10%		
PACE rejection/enhancement	Without Pace enhancement or pace rejection		
Waveform Display	Consistent with the calculation leads.		
Compliant with Standard and Directive	Complies with the requirements in terms of short circuit protection and leakage current in EN60601-1.		
Defib Sync Pulse			
Output wave	Square pulse		
Output impedance	<500 Ω		

Maximum Time Delay	35mS (R-wave peak to leading edge of pulse)
Amplitude	High level: 3.5 to 5 V, providing a maximum of 1 mA output current; Low level: < 0.5V, receiving a maximum of 5 mA input current.
Minimum required R wave amplitude	0.3mV
Pulse width	100ms $\pm$ 10%
Limited current	15 mA rating
Rising and falling time	< 1 ms

## A.5 RESP

Measurement method	Trans-thoracic impedance
Measurement lead	Lead Options are lead I and II. The default lead is lead II.
Waveform amplitude	$\times 0.25, \times 0.5, \times 1, \times 2, \times 3, \times 4, \times 5$
Waveform speed	6.25mm/s, 12.5mm/s, 25.0mm/s, , 50mm/s
Respiration excitation waveform	< 300 $\mu$ A, sinusoid, 62.8 kHz ( $\pm$ 10%)
Measuring sensitivity	0.3 $\Omega$ (base impedance 200 to 4500 $\Omega$ )
Base impedance range	200 to 2500 $\Omega$ (cable resistance = 0 K)
	2200 to 4500 $\Omega$ (leads cables 1K $\Omega$ resistance)
Maximum dynamic range	500 $\Omega$ base impedance, 3 $\Omega$ variable impedance
Waveform bandwidth	0.2 to 2.5 Hz (-3 dB)
Differential input impedance	>5 M $\Omega$
RR measuring range	
Adult	0 to 120 rpm
Neo/Ped	0 to 150 rpm
Resolution	1 rpm
Accuracy	
Adult	6 to 120 rpm: $\pm 2$ rpm 0 to 5 rpm: not specified

Neo/Ped	6 to 150 rpm: $\pm 2$ rpm 0 to 5 rpm: not specified
Apnea Alarm delay	10s, 15s, 20s, 25s, 30s, 35s, 40s. The default value is 20s.

## A.6 NIBP

### EDAN Module

Measurement Method	Oscillometric
Mode	Manual, Auto, Continuous
Measuring interval in AUTO Mode	1/2/3/4/5/10/15/30/60/90/120/240/480 min
Continuous	5min, interval is 5s
Measuring type	SYS, DIA, MAP, PR
Measurement Range	
Adult mode	SYS: 40 mmHg ~ 270 mmHg DIA: 10 mmHg ~ 215 mmHg MAP: 20 mmHg ~ 235 mmHg
Pediatric mode	SYS: 40 mmHg ~ 200 mmHg DIA: 10 mmHg ~ 150 mmHg MAP: 20 mmHg ~ 165 mmHg
Neonatal mode	SYS: 40 mmHg ~ 135 mmHg DIA: 10 mmHg ~ 100 mmHg MAP: 20 mmHg ~ 110 mmHg
Cuff pressure measuring range	0 mmHg ~ 300 mmHg
Accuracy	
Maximum mean error	$\pm 5$ mmHg
Maximum standard deviation	8mmHg
Pressure resolution	1mmHg
Maximum measuring period	
Adult/Pediatric	120s
Neonate	90s
Typical measuring period	30s ~ 45s (depend on HR/motion disturbance)
Overpressure protection	

Adult	297±3mmHg
Pediatric	240±3mmHg
Neonatal	147±3mmHg
PR	
Measurement range	40 bpm ~240bpm
Accuracy	±3bpm or 3.5%, whichever is greater

**Omron Module**

Method	Oscillometric
Mode	Manual, Auto, Continuous
Measuring Interval in AUTO Mode	1/2/3/4/5/10/15/30/60/90 min, 2/4/8h
Continuous	5min, interval is 5s
Maximum measurement period	Adult/ Pediatric: 160s Neonatal: 80s
PR Measurement Range	Adult/ Pediatric mode: 40bpm ~ 200bpm
	Neonatal mode: 40 bpm ~ 240bpm
PR Accuracy	± 2 bpm or 2% of the readings
Measurement Range	
Adult/ Pediatric Mode	SYS: 60 mmHg ~ 250 mmHg DIA: 40 mmHg ~ 200 mmHg MAP: 45 mmHg ~ 235 mmHg
Neonatal Mode	SYS: 40 mmHg ~ 120 mmHg DIA: 20 mmHg ~ 90 mmHg MAP: 30 mmHg ~ 100 mmHg
Cuff pressure measuring range	0 mmHg ~ 300 mmHg
Pressure Resolution	1mmHg
Accuracy	
Maximum Mean Error	±5mmHg
Maximum Standard Deviation	8mmHg

## A.7 SpO<sub>2</sub>

### EDAN Module

Measurement Range	0 ~ 100 %
Resolution	1 %
Accuracy	
Adult (including Pediatric)	±2 % (70%~100% SpO <sub>2</sub> )
	Undefined (0~69% SpO <sub>2</sub> )
Neonate	±3 % (70%~100% SpO <sub>2</sub> )
	Undefined (0~69% SpO <sub>2</sub> )
Pulse Rate	
Measuring Range	25bpm ~ 300bpm
Resolution	1bpm
Accuracy	±2bpm
Data update period	1s
Sensor	Wave length: Red light: 660±3 nm; Infrared light: 905±5 nm
	Emitted light energy: <15mW

### Nellcor Module

Measuring Range	1% ~ 100%	
Resolution	1%	
Data update period	1s	
Accuracy	Sensor Type	Accuracy
	DS-100A, OXI-A/N	± 3%(70% ~ 100% SpO <sub>2</sub> )
* When the sensor is used to neotate as recommendation, the specified accuracy range of the neotate is always higher ±1 than adult.		
Pulse Rate		
Measuring Range	20bpm ~ 300bpm	
Resolution	1bpm	
Accuracy	± 3bpm (20bpm ~ 250bpm)	
Sensor	Wave length: approximately 660 and 900nm	
	Emitted light energy: <15mW	

## A.8 TEMP

Measurement method	Thermal resistance
Channel	2
Sensor type	YSI-10K and YSI-2.252K
Measuring Range	0 °C ~ 50 °C
Resolution	0.1°C
Accuracy (Without sensor)	±0.1°C
Unit	°C, °F
Refresh Time	1s ~ 2s

## A.9 Quick TEMP

Measuring Range	25°C ~ 45°C(monitored mode) 35.5°C ~ 42°C(prediction mode)
Operating Temp	10°C ~ 40°C
Sensor Type	Oral/Axillary sensor, Rectal sensor
Resolution	0.1°C
Accuracy(without sensor)	±0.1°C (25°C ~ 45°C) (monitored mode)
Response time	< 60s
Update time	1s ~ 2s
Warm-up time	Less than 10 seconds
Prediction time	Less than 30 seconds

## A.10 IBP

Measurement method	Direct invasive measurement
Channel	iM80: 4 channels iM50/iM60/iM70: 2 channels
Pressure sensor	
Sensitivity	5 (µV/V/mmHg)
Impedance range	300 to 3000 Ω
Frequency response	d.c. to 12.5 or 40 Hz
Zero	Range: ±200 mmHg



Unit	kPa, mmHg
Measuring range	
Art	0 to 300 mmHg
PA	-6 to +120mmHg
CVP/RAP/LAP/ICP	-10 to +40 mmHg
P1/P2	-50 to +300 mmHg
Resolution	1 mmHg
Accuracy (without sensor)	$\pm 2\%$ or 1 mmHg, whichever is greater

## A.11 CO<sub>2</sub>

### EDAN Module

Intended patient	Adult, pediatric, neonatal		
Measurement method	Non-dispersive infrared gas analysis (NDIR)		
Unit	mmHg, %, kPa		
Measuring Range	CO <sub>2</sub>	0 mmHg ~ 150 mmHg (0 % ~ 20%)	
	AwRR	2 rpm ~ 150 rpm	
Resolution	CO <sub>2</sub>	1mmHg	
	AwRR	1rpm	
Accuracy	EtCO <sub>2</sub>	$\pm 2$ mmHg, 0mmHg ~ 40 mmHg	Typical conditions: Ambient temperature: $25\pm 3^{\circ}\text{C}$ Barometric pressure: $760\pm 10$ mmHg Balance gas: N <sub>2</sub> Respiratory rate: not exceed 60rpm Sample gas flowrate: 100ml/min
		$\pm 5\%$ of reading, 41 mmHg ~ 70 mmHg	
		$\pm 8\%$ of reading, 71 mmHg ~ 100 mmHg	
		$\pm 10\%$ of reading, 101 mmHg ~ 150 mmHg	
	$\pm 12\%$ or $\pm 4$ mmHg of reading, whichever is greater	All conditions	
	AwRR	$\pm 1$ rpm	
Sample gas Flowrate	70ml/min or 100ml/min, optional ( $\pm 15$ ml/min)		
Warm-up time	Display reading within 20s; reach to the designed accuracy within 2 minutes.		

Rise time	400ms (typical value, using water trap, sample gas flowrate:100ml/min)
Response time	<4s (water trap) with 2m gas sampling tube, sample gas flowrate: 100ml/min
Work mode	Standby, measure; default: measure
Respiratory inspection	The value of concentration change is greater than 1 vol%.
O <sub>2</sub> compensation	Range: 0%~100% Resolution: 1% Default: 16%
N <sub>2</sub> O compensation	Range: 0%~100% Resolution: 1% Default: 0%
AG compensation	Range: 0%~20% Resolution: 0.1% Default: 0%
Humidity compensation method	ATPD(default), BTPS
Barometric pressure compensation	Automatic
Calibration	Support
Alarm	EtCO <sub>2</sub> , FiCO <sub>2</sub> , AwRR
Apnea alarm delay	10s, 15s, 20s, 25s, 30s, 35s, 40s; default value is 20s.

### Respironics Module

Intended patient	Adult, pediatric, neonatal
Measurement method	Infra-red Absorption Technique
Unit	mmHg, %, Kpa
Measuring Range	
EtCO <sub>2</sub>	0 mmHg ~ 150 mmHg
FiCO <sub>2</sub>	3 mmHg ~50 mmHg
AwRR	2 rpm ~ 150 rpm(sidestream) 0 rpm ~ 150 rpm(mainstream)
Resolution	
EtCO <sub>2</sub>	1mmHg
FiCO <sub>2</sub>	1mmHg

AwRR	1 rpm
EtCO <sub>2</sub> Accuracy	± 2 mmHg, 0 to 40 mmHg
	± 5 % of reading, 41 to 70 mmHg
	± 8 % of reading, 71 to 100 mmHg
	± 10 % of reading, 101 to 150 mmHg
	± 12 % of reading, RESP measurement value exceeds 80rpm (sidestream)
AwRR Accuracy	± 1 rpm
Sample Gas Flowrate (sidestream)	50 ± 10ml/min
Stability	
Short Term Drift	Less than 0.8 mmHg over four hours
Long Term Drift	Accuracy specification will be maintained over a 120 hour period
O <sub>2</sub> Compensation	
Range	0 ~ 100%
Resolution	1%
Default	16%
GAS Compensation	
Range	0 ~ 20%
Resolution	0.1%
Default	0.0%
Zero	Support
Work Mode	Standby, Measurement
Barometric pressure compensation	User setup
Balance gas compensation	Including Helium, N <sub>2</sub> O and room air
Apnea Alarm Delay	10s, 15s, 20s, 25s, 30s, 35s, 40s; default value is 20s.

Interfering Gas Effect on EtCO<sub>2</sub> Measurement Values:

Gas or vapor	Gas level (%)	Quantitative effect/Comments
Nitrous oxide	60	Dry and Saturated Gas
Halothane	4	0 – 40 mmHg: ± 1 mmHg additional error
Enflurane	5	41 – 70 mmHg: ± 2.5% additional error

Isoflurane	5	71 – 100 mmHg: $\pm 4\%$ additional error
Sevoflurane	5	101 – 150 mmHg: $\pm 5\%$ additional error
Xenon	80	<p>*Additional worst case error when compensation for <math>P_B</math>, <math>O_2</math>, <math>N_2O</math>, anesthetic agents, or helium is correctly selected for the actual fractional gas constituents present.</p> <p>Desflurane:</p> <p>The presence of desflurane in the exhaled breath at concentrations greater than 5% will positively bias Carbon Dioxide values by up to an additional 3 mmHg at 38mmHg.</p> <p>Xenon:</p> <p>The presence of Xenon in the exhaled breath will negatively bias Carbon Dioxide values by up to an additional 5 mmHg at 38mmHg.</p>
Helium	50	
Desflurane	15	

Barometric Pressure on EtCO<sub>2</sub> Measurement Values:

Quantitative effect
Ambient Barometric, Operational
0 – 40 mmHg: $\pm 1$ mmHg additional error
41 – 70 mmHg: $\pm 2.5\%$ additional error
71 – 100 mmHg: $\pm 4\%$ additional error
101 – 150 mmHg: $\pm 5\%$ additional error
*Additional worst case error when compensation for $P_B$ , $O_2$ , $N_2O$ , anesthetic agents, or helium is correctly selected for the actual fractional gas constituents present.

## A.12 C.O.

Intended patient	Adult
Measurement method	Thermodilution Technique
Measuring range	
C.O.	0.1 L/min ~ 20L/min
TB	23°C ~ 43°C
TI	-1°C ~ 27°C
Resolution	
C.O.	0.1L/min
TB, TI	+0.1°C
Accuracy	

C.O.	$\pm 5\%$ or 0.2 L/min, whichever is greater
TB	$\pm 0.1^{\circ}\text{C}$ (without sensor)
TI	$\pm 0.1^{\circ}\text{C}$ (without sensor)

## A.13 AG

### A.13.1 Phasein Sidestream

Temperature		
Working		+5°C ~ +40°C
Transport and Storage		-20°C ~ +55°C
Humidity		
Working		25% ~ 80% (non-condensing)
Transport and Storage		25% ~ 93% (non-condensing)
Altitude		
Working		860hPa ~ 1060hPa
Transport and Storage		700hPa ~ 1060hPa
Module Type	ISA AX+ Analyzer	Displaying the concentration of CO <sub>2</sub> , N <sub>2</sub> O, and two anaesthesia agent and identifying the anaesthesia agent automatically (portable module)
	ISA OR+ Analyzer	Displaying the concentration of CO <sub>2</sub> , O <sub>2</sub> , N <sub>2</sub> O, and two anaesthesia agent and identifying the anaesthesia agent automatically (portable module)
Measurement Parameters	CO <sub>2</sub> , N <sub>2</sub> O, O <sub>2</sub> , Halothane (HAL), Isoflurane(ISO), Enflurane(ENF), Sevoflurane(SEV), Desflurane(DES), awRR, MAC	
Measurement Principle	CO <sub>2</sub> , N <sub>2</sub> O, Anaesthesia Agent: infra-red absorption characteristic; O <sub>2</sub> : Paramagnetic method	
Sampling Flow Rate	50±10ml/min	
Work Mode	Measurement	
Warm-up Time	< 20s	

Typical Rise Time	$\text{CO}_2 \leq 200\text{ms}$ $\text{HAL, ISO, ENF, SEV, DES} \leq 350\text{ms}$ $\text{N}_2\text{O} \leq 350\text{ms}$ $\text{O}_2 \leq 450\text{ms}$				
Primary Anaesthesia Agent Threshold	$\leq 0.15 \text{ vol}\%$				
Second Anaesthesia Agent Threshold	$0.2 \text{ vol}\% + 10\%$				
Agent Identificaiton Time	< 20 seconds (typically < 10 seconds)				
Total System Response Time	< 3 seconds				
Data Update Time	1 second				
Accuracy(Standard Conditions)					
GAS	Measurement Range	Accuracy			
CO <sub>2</sub>	0 to 15 vol%	$\pm(0.2 \text{ vol}\% + 2\% \text{ of reading})$			
	15 to 25 vol%	Unspecified			
N <sub>2</sub> O	0 to 100 vol%	$\pm(2 \text{ vol}\% + 2\% \text{ of reading})$			
HAL, ENF, ISO	0 to 8 vol %	$\pm(0.15 \text{ vol}\% + 5\% \text{ of reading})$			
	8 to 25 vol %	Unspecified			
SEV	0 to 10 vol %	$\pm(0.15 \text{ vol}\% + 5\% \text{ of reading})$			
	10 to 25 vol %	Unspecified			
DES	0 to 22 vol %	$\pm(0.15 \text{ vol}\% + 5\% \text{ of reading})$			
	22 to 25 vol %	Unspecified			
O <sub>2</sub>	0 to 100 vol %	$\pm(1 \text{ vol}\% + 2\% \text{ of reading})$			
Apnea Alarm Delay	10s, 15s, 20s, 25s, 30s, 35s, 40s; default value is 20s.				
Zero	Support				
O <sub>2</sub> Compensation	Support				
N <sub>2</sub> O Compensation	Support				
Interfering gas and vapor effects					
Gas or vapour	Gas level	CO <sub>2</sub>		Agents	N <sub>2</sub> O
		ISA CO <sub>2</sub>	ISA AX+		

N <sub>2</sub> O <sup>4)</sup>	60 vol%	- <sup>2)</sup>	- <sup>1)</sup>	- <sup>1)</sup>	- <sup>1)</sup>
HAL <sup>4)</sup>	4 vol%	- <sup>1)</sup>	- <sup>1)</sup>	- <sup>1)</sup>	- <sup>1)</sup>
ENF, ISO, SEV <sup>4)</sup>	5 vol%	+8% of reading <sup>3)</sup>	- <sup>1)</sup>	- <sup>1)</sup>	- <sup>1)</sup>
DES <sup>4)</sup>	15 vol%	+12% of reading <sup>3)</sup>	- <sup>1)</sup>	- <sup>1)</sup>	- <sup>1)</sup>
Xe(Xenon) <sup>4)</sup>	80 vol%	-10% of reading <sup>3)</sup>		- <sup>1)</sup>	- <sup>1)</sup>
He(Helium) <sup>4)</sup>	50 vol%	-6% of reading <sup>3)</sup>		- <sup>1)</sup>	- <sup>1)</sup>
Metered dose inhaler propellants <sup>4)</sup>	Not for use with metered dose inhaler propellants				
C <sub>2</sub> H <sub>5</sub> OH(Ethanol) <sup>4)</sup>	0.3 vol%	- <sup>1)</sup>	- <sup>1)</sup>	- <sup>1)</sup>	- <sup>1)</sup>
C <sub>3</sub> H <sub>7</sub> OH (Isopropanol) <sup>4)</sup>	0.5 vol%	- <sup>1)</sup>	- <sup>1)</sup>	- <sup>1)</sup>	- <sup>1)</sup>
CH <sub>3</sub> COCH <sub>3</sub> (Acetone) <sup>4)</sup>	1 vol%	- <sup>1)</sup>	- <sup>1)</sup>	- <sup>1)</sup>	- <sup>1)</sup>
CH <sub>4</sub> (Methane) <sup>4)</sup>	3 vol%	- <sup>1)</sup>	- <sup>1)</sup>	- <sup>1)</sup>	- <sup>1)</sup>
CO(Carbon monoxide) <sup>5)</sup>	1 vol%	- <sup>1)</sup>	- <sup>1)</sup>	- <sup>1)</sup>	- <sup>1)</sup>
NO(Nitrogen monoxide)	0.02 vol%	- <sup>1)</sup>	- <sup>1)</sup>	- <sup>1)</sup>	- <sup>1)</sup>
O <sub>2</sub> <sup>5)</sup>	100 vol%	- <sup>2)</sup>	- <sup>2)</sup>	- <sup>1)</sup>	- <sup>1)</sup>

Note 1: Interference at indicated gas level. For example, 50 vol% Helium typically decreases the CO<sub>2</sub> readings by 6%. This means that if measuring on a mixture containing 5.0 vol% CO<sub>2</sub> and 50 vol% Helium, the actual measured CO<sub>2</sub> concentration will typically be (1-0.06)\*5.0 vol% =4.7 vol% CO<sub>2</sub>.

Note 2: In addition to the EN ISO 21647 standard.

### A.13.2 Phasein Mainstream

Temperature	
Working	+10°C ~ +40°C
Transport and Storage	-20°C ~ +55°C

Humidity		
Working		25% ~ 80% (non-condensing)
Transport and Storage		25% ~ 93% (non-condensing)
Altitude		
Working		860hPa ~ 1060hPa
Transport and Storage		700hPa ~ 1060hPa
Module Type	IRMA AX+	Displaying the concentration of CO <sub>2</sub> , N <sub>2</sub> O and two anaesthesia agent and indentifying two anaesthesia agent
Measurement Parameters	CO <sub>2</sub> , N <sub>2</sub> O, HAL, Isoflurane(ISO), Enflurane(ENF), Sevoflurane(SEV), Desflurane(DES), awRR, MAC	
Measurement Principle	CO <sub>2</sub> , N <sub>2</sub> O, anaesthesia agent: infra-red absorption characteristic	
Warm-up Time	Concentrations are reported and the automatic agent indentification is running within 10 seconds. 20 seconds for IRMA AX+.	
Rise Time	CO <sub>2</sub> ≤ 90ms N <sub>2</sub> O ≤ 300ms HAL, ISO, ENF, SEV, DES ≤ 300ms	
Primary Agent Threshold	0.15 vol%	
Secondary Agent Threshold	0.2 vol% + 10% of total agent concentration	
Agent Identificaiton Time	< 20 seconds (typically less than 10 seconds)	
Response Time	< 1 second	
Data Update Time	1 second	
Accuracy(Standard Conditions)		
Gas	Range	Accuracy
CO <sub>2</sub>	0 ~ 10 vol%	±(0.2 vol% + 2% of reading)
	10 ~ 15 vol%	±(0.3 vol% + 2% of reading)
	15 ~ 25 vol%	Unspecified



N <sub>2</sub> O	0 to 100 vol%	±(2 vol% + 2% of reading)			
HAL	0 to 8 vol%	±(0.15 vol% + 5% of reading)			
ISO	8 to 25 vol%	Unspecified			
ENF					
SEV	0 to 10 vol%	±(0.15 vol% + 5% of reading)			
	10 to 25 vol%	Unspecified			
DES	0 to 22 vol%	±(0.15 vol% + 5% of reading)			
	22 to 25 vol%	Unspecified			
AwRR accuracy	±1rpm				
Real-time gas concentration monitoring	Support				
Zero	Support				
Work Mode	Measurement				
Apnea Alarm Delay	10s, 15s, 20s, 25s, 30s, 35s, 40s; default value is 20s.				
Interfering gas and vapour effects					
Gas or vapour	Gas level	CO <sub>2</sub>		Agents	N <sub>2</sub> O
		IRMA CO <sub>2</sub>	IRMA AX+		
N <sub>2</sub> O <sup>4)</sup>	60 vol%	- <sup>1</sup> &2)	- <sup>1</sup> &2)	- <sup>1)</sup>	- <sup>1)</sup>
HAL <sup>4)</sup>	4 vol%	- <sup>1)</sup>	- <sup>1)</sup>	- <sup>1)</sup>	- <sup>1)</sup>
ENF, ISO, SEV <sup>4)</sup>	5 vol%	+8% of reading <sup>3)</sup>	- <sup>1)</sup>	- <sup>1)</sup>	- <sup>1)</sup>
DES <sup>4)</sup>	15 vol%	+12% of reading <sup>3)</sup>	- <sup>1)</sup>	- <sup>1)</sup>	- <sup>1)</sup>
Xe(Xenon) <sup>4)</sup>	80 vol%	-10% of reading <sup>3)</sup>		- <sup>1)</sup>	- <sup>1)</sup>
He(Helium) <sup>4)</sup>	50 vol%	-6% of reading <sup>3)</sup>		- <sup>1)</sup>	- <sup>1)</sup>
Metered dose inhaler propellants <sup>4)</sup>	Not for use with metered dose inhaler propellants				
C <sub>2</sub> H <sub>5</sub> OH(Ethanol) <sup>4)</sup>	0.3 vol%	- <sup>1)</sup>	- <sup>1)</sup>	- <sup>1)</sup>	- <sup>1)</sup>
C <sub>3</sub> H <sub>7</sub> OH (Isopropanol) <sup>4)</sup>	0.5 vol%	- <sup>1)</sup>	- <sup>1)</sup>	- <sup>1)</sup>	- <sup>1)</sup>

CH <sub>3</sub> COCH <sub>3</sub> (Acetone) <sup>4)</sup>	1 vol%	- <sup>1)</sup>	- <sup>1)</sup>	- <sup>1)</sup>	- <sup>1)</sup>
CH <sub>4</sub> (Methane) <sup>4)</sup>	3 vol%	- <sup>1)</sup>	- <sup>1)</sup>	- <sup>1)</sup>	- <sup>1)</sup>
CO(Carbon monoxide) <sup>5)</sup>	1 vol%	- <sup>1)</sup>	- <sup>1)</sup>	- <sup>1)</sup>	- <sup>1)</sup>
NO	0.02 vol%	- <sup>1)</sup>	- <sup>1)</sup>	- <sup>1)</sup>	- <sup>1)</sup>
O <sub>2</sub> <sup>5)</sup>	100 vol%	- <sup>1&amp;2)</sup>	- <sup>1&amp;2)</sup>	- <sup>1)</sup>	- <sup>1)</sup>

Note 1: For probes not measuring N<sub>2</sub>O and/or O<sub>2</sub> the concentrations shall be set from monitor. (IRMA CO<sub>2</sub> measures neither N<sub>2</sub>O, nor O<sub>2</sub>. IRMA AX+ does not measure O<sub>2</sub>.)

Note 2: Interference at indicated gas level. For example, 50 vol% Helium typically decreases the CO<sub>2</sub> readings by 6%. This means that if measuring on a mixture containing 5.0 vol% CO<sub>2</sub> and 50 vol% Helium, the measured CO<sub>2</sub> concentration will typically be  $(1-0.06)*5.0 \text{ vol\%} = 4.7 \text{ vol\% CO}_2$ .

Note 3: In addition to the EN ISO 21647 standard.

## B EMC Information

### - Guidance and Manufacture's Declaration

#### B.1 Electromagnetic Emissions - for all EQUIPMENT and SYSTEMS

<b>Guidance and manufacture's declaration – electromagnetic emission</b>		
The monitor is intended for use in the electromagnetic environment specified below. The customer or the user of the monitor should assure that it is used in such an environment.		
<b>Emission test</b>	<b>Compliance</b>	<b>Electromagnetic environment – guidance</b>
RF emissions CISPR 11	Group 1	The monitor uses RF energy only for its internal function. Therefore, its RF emissions are very low and are not likely to cause any interference in nearby electronic equipment.
RF emission CISPR 11	Class A	The monitor is suitable for use in all establishments, other than domestic establishments and those directly connected to the public low-voltage power supply network that supplies buildings used for domestic purposes.
Harmonic emissions IEC/EN 61000-3-2	Class A	
Voltage fluctuations/ flicker emissions IEC/EN 61000-3-3	Complies	

#### B.2 Electromagnetic Immunity - for all EQUIPMENT and SYSTEMS

<b>Guidance and manufacture's declaration – electromagnetic immunity</b>			
The monitor is intended for use in the electromagnetic environment specified below. The customer or the user of the monitor should assure that it is used in such an environment.			
<b>Immunity test</b>	<b>IEC/EN 60601 test level</b>	<b>Compliance level</b>	<b>Electromagnetic environment - guidance</b>
Electrostatic discharge (ESD) IEC/EN 61000-4-2	±6 kV contact ±8 kV air	±6 kV contact ±8 kV air	Floors should be wood, concrete or ceramic tile. If floor are covered with synthetic material, the relative humidity should be at least 30%.

Electrical fast transient/burst IEC/EN 61000-4-4	$\pm 2$ kV for power supply lines $\pm 1$ kV for input /output signal	$\pm 2$ kV for power supply lines $\pm 1$ kV for input /output signal	Mains power quality should be that of a typical commercial or hospital environment.
Surge IEC/EN 61000-4-5	$\pm 1$ kV for line to line $\pm 2$ kV for line to ground	$\pm 1$ kV for line to line $\pm 2$ kV for line to ground	Mains power quality should be that of a typical commercial or hospital environment.
Power frequency (50/60Hz) magnetic field IEC/EN 61000-4-8	3A/m	3A/m	Power frequency magnetic fields should be at levels characteristic of a typical location in a typical commercial or hospital environment.
Voltage dips, short interruptions and voltage variations on power supply input lines IEC/EN 61000-4-11	$<5\% U_T$ ( $>95\%$ dip in $U_T$ ) for 0.5 cycle  $40\% U_T$ ( $60\%$ dip in $U_T$ ) for 5 cycles  $70\% U_T$ ( $30\%$ dip in $U_T$ ) for 25 cycles  $<5\% U_T$ ( $>95\%$ dip in $U_T$ ) for 5 sec	$<5\% U_T$ ( $>95\%$ dip in $U_T$ ) for 0.5 cycle  $40\% U_T$ ( $60\%$ dip in $U_T$ ) for 5 cycles  $70\% U_T$ ( $30\%$ dip in $U_T$ ) for 25 cycles  $<5\% U_T$ ( $>95\%$ dip in $U_T$ ) for 5 sec	Mains power quality should be that of a typical commercial or hospital environment. If the user of the Patient Monitor requires continued operation during power mains interruptions, it is recommended that the Patient Monitor be powered from an uninterruptible power supply or a battery.
<b>NOTE</b> $U_T$ is the a.c. mains voltage prior to application of the test level.			

## B.3 Electromagnetic Immunity - for EQUIPMENT and SYSTEMS that are not LIFE-SUPPORTING

<b>Guidance and manufacture's declaration – electromagnetic immunity</b>			
The Patient Monitor is intended for use in the electromagnetic environment specified below. The customer or the user of Patient Monitor should assure that it is used in such an environment.			
<b>Immunity test</b>	<b>IEC/EN 60601 test level</b>	<b>Compliance level</b>	<b>Electromagnetic environment - guidance</b>
<p>Conducted RF IEC/EN 61000-4-6</p> <p>Radiated RF IEC/EN 61000-4-3</p>	<p>3 V<sub>rms</sub> 150 kHz to 80 MHz</p> <p>3 V/m 80 MHz to 2.5 GHz</p>	<p>3 V<sub>rms</sub></p> <p>3 V/m</p>	<p>Portable and mobile RF communications equipment should be used no closer to any part of the Patient Monitor, including cables, than the recommended separation distance calculated from the equation applicable to the frequency of the transmitter.</p> <p><b>Recommended separation distance</b></p> $d = \left[ \frac{3.5}{V_1} \right] \sqrt{P}$ $d = \left[ \frac{3.5}{E_1} \right] \sqrt{P} \quad 80 \text{ MHz to } 800 \text{ MHz}$ $d = \left[ \frac{7}{E_1} \right] \sqrt{P} \quad 800 \text{ MHz to } 2.5 \text{ GHz}$ <p>Where P is the maximum output power rating of the transmitter in watts (W) according to the transmitter manufacturer and d is the recommended separation distance in meters (m).</p> <p>Field strengths from fixed RF transmitters, as determined by an electromagnetic site survey,<sup>a</sup> should be less than the compliance level in each frequency range.<sup>b</sup></p> <p>Interference may occur in the vicinity of equipment marked with the following symbol:</p>

			
<b>NOTE 1</b> At 80 MHz and 800 MHz, the higher frequency range applies.			
<b>NOTE 2</b> These guidelines may not apply in all situations. Electromagnetic propagation is affected by absorption and reflection from structures, objects and people.			
<sup>a</sup>	Field strengths from fixed transmitters, such as base stations for radio (cellular/cordless) telephones and land mobile radios, amateur radio, AM and FM radio broadcast and TV broadcast cannot be predicted theoretically with accuracy. To assess the electromagnetic environment due to fixed RF transmitters, an electromagnetic site survey should be considered. If the measured field strength in the location in which the Patient Monitor is used exceeds the applicable RF compliance level above, the Patient Monitor should be observed to verify normal operation. If abnormal performance is observed, additional measures may be necessary, such as reorienting or relocating the Patient Monitor.		
<sup>b</sup>	Over the frequency range 150kHz to 80MHz, field strengths should be less than 3V/m.		

## B.4 Recommended Separation Distances

<b>Recommended separation distances between portable and mobile RF communications equipment and the monitor</b>			
The monitor is intended for use in an electromagnetic environment in which radiated RF disturbances are controlled. The customer or the user of the monitor can help prevent electromagnetic interference by maintaining a minimum distance between portable and mobile RF communications equipment (transmitters) and the monitor as recommended below, according to the maximum output power of the communications equipment.			
<b>Rated maximum output power of transmitter  (W)</b>	<b>Separation distance according to frequency of transmitter(m)</b>		
	<b>150 kHz to 80 MHz</b>	<b>80 MHz to 800 MHz</b>	<b>800 MHz to 2.5 GHz</b>
	$d = \left[ \frac{3.5}{V_1} \right] \sqrt{P}$	$d = \left[ \frac{3.5}{E_1} \right] \sqrt{P}$	$d = \left[ \frac{7}{E_1} \right] \sqrt{P}$
0.01	0.12	0.12	0.23
0.1	0.37	0.37	0.73
1	1.2	1.2	2.3
10	3.7	3.7	7.3
100	12	12	23
For transmitters rated at a maximum output power not listed above, the recommended separation distance d in meters (m) can be estimated using the equation applicable to the frequency of the transmitter, where P is the maximum output power rating of the transmitter in watts (W) according to the transmitter manufacturer.			

**NOTE 1** At 80 MHz and 800 MHz, the separation distance for the higher frequency range applies.

**NOTE 2** These guidelines may not apply in all situations. Electromagnetic propagation is affected by absorption and reflection from structures, objects and people.

## C Default Settings

This appendix documents the most important default settings of your monitor as it is delivered from the factory.

Note: If your monitor has been ordered preconfigured to your requirements, the settings at delivery will be different from those listed here.

### C.1 Patient Information Default Settings

Patient Information Settings	
Patient Type	Adult
Pace	Off

### C.2 Alarm Default Settings

Alarm Settings	
Pause Time	120s
Mute	On
Sensor Off Alarm	On
Alarm Latch	Unlatch

### C.3 ECG Default Settings

ECG Settings	ADU	PED	NEO
Alarm Switch	On		
Alarm Record	Off		
Alarm Level	Medium		
Alarm High Limit	120	160	200
Alarm Low Limit	50	75	100
Pace	Off		
Lead Type	5 Leads		
Display	Normal		
Filter	Monitor		
Smart Lead Off	Off		
Heart Volume	2		
ST Analysis	ADU	PED	NEO



ST Analysis	Off		
Alarm Switch	Off		
Alarm Level	Medium		
Alarm Record	Off		
Alarm High Limit (ST-X)	0.2		
Alarm Low Limit (ST-X)	-0.2		
X stands for I, II, III, aVR, aVL, aVF, V, V1, V2, V3, V4, V5 or V6.			
ARR Analysis			
ARR Analysis	On		
PVCs Alarm Level	Medium		
PVCs Alarm Switch	Off		
PVCs Alarm Record	Off		
ARR Alarm Settings	Alarm Switch	Alarm Level	Alarm Record
ASYSTOLE	On	High	Off
VFIB/VTAC	On	High	Off
R ON T	On	Medium	Off
VT > 2	On	Medium	Off
COUPLET	On	Medium	Off
PVC	On	Medium	Off
BIGEMINY	On	Medium	Off
TRIGEMINY	On	Medium	Off
TACHY	On	Medium	Off
BRADY	On	Medium	Off
MISSEDBEATS	On	Medium	Off
IRR	On	Medium	Off
PNC	On	Medium	Off
PNP	On	Medium	Off
VBRADY	On	Medium	Off
VENT	On	Medium	Off

## C.4 RESP

RESP Settings	ADU	PED	NEO
Alarm Switch	On		
Alarm Record	Off		
Alarm Level	Medium		
Alarm High Limit	30	30	100
Alarm Low Limit	8	8	30
Apnea Time	20s		
Calculation Type	Auto		
Resp Type	II		
Sweep	12.5mm/s		
Amplitude	1		

## C.5 SpO<sub>2</sub>

SpO <sub>2</sub> Settings	ADU	PED	NEO
Alarm Switch	On		
Alarm Record	Off		
Alarm Level	Medium		
Alarm High Limit	100	100	95
Alarm Low Limit	90	90	88
Pitch Tone	On		
Sweep	12.5mm/s		

## C.6 PR

PR Settings	ADU	PED	NEO
PR Source	SpO <sub>2</sub>		
Alarm Switch	On		
Alarm Record	Off		
Alarm Level	Medium		
Alarm High Limit	120	160	200
Alarm Low Limit	50	75	100

Pulse Volume	3
Alarm Source	Auto

## C.7 NIBP

NIBP Settings	ADU	PED	NEO
Alarm Switch	On		
Alarm Record	Off		
Alarm Level	Medium		
Alarm High Limit (SYS)	160	120	90
Alarm Low Limit (SYS)	90	70	40
Alarm High Limit (Map)	110	90	70
Alarm Low Limit (Map)	60	50	30
Alarm High Limit (Dia)	90	70	60
Alarm Low Limit (Dia)	50	40	20
EDAN Module			
Inflation value	160	140	100
Omron Module			
Inflation value	180	180	120
Unit	mmHg		
Interval	Manual		

## C.8 TEMP

TEMP Settings	ADU	PED	NEO
Alarm Switch	On		
Alarm Record	Off		
Alarm Level	Medium		
Alarm High Limit (T1)	39.0	39.0	39.0
Alarm Low Limit (T1)	36.0	36.0	36.0
Alarm High Limit (T2)	39.0	39.0	39.0
Alarm Low Limit (T2)	36.0	36.0	36.0
Alarm High Limit (TD)	2.0	2.0	2.0

Unit	°C
------	----

## C.9 Quick TEMP

Quick TEMP Settings	ADU	PED	NEO
Alarm Switch	On		
Alarm Record	Off		
Alarm Level	Medium		
Alarm High Limit (T1)	39.0	39.0	/
Alarm Low Limit (T1)	36.0	36.0	/
Unit	°C		

## C.10 IBP

IBP Settings	ADU	PED	NEO
Alarm Switch	On		
Alarm Record	Off		
Alarm Level	Medium		
Unit	mmHg		
Filter	12.5Hz		
	SYS, DIA, MAP	SYS, DIA, MAP	SYS, DIA, MAP
Alarm High Limit (ART, P1, P2)	160, 90, 110	160, 90, 110	160, 90, 110
Alarm Low Limit (ART, P1, P2)	90, 50, 70	90, 50, 70	90, 50, 70
Alarm High Limit (PA)	35, 16, 20	35, 16, 20	35, 16, 20
Alarm Low Limit (PA)	10, 0, 0	10, 0, 0	10, 0, 0
	MAP	MAP	MAP
Alarm High Limit (CVP, RAP, LAP, ICP)	10	10	10
Alarm Low Limit (CVP, RAP, LAP, ICP)	0	0	0

## C.11 CO<sub>2</sub>

CO2 Settings	ADU	PED	NEO
Alarm Switch	On		
Alarm Record	Off		
Alarm Level	Medium		
Work Mode	Standby		
Unit	mmHg		
Apnea Time	20s		
O <sub>2</sub> Compensate	16%		
Anes Agent	0%		
Alarm High Limit (EtCO <sub>2</sub> )	50	50	45
Alarm Low Limit (EtCO <sub>2</sub> )	15	20	30
Alarm High Limit (FiCO <sub>2</sub> )	4	4	4
Alarm High Limit (AWRR)	30	30	100
Alarm Low Limit (AWRR)	8	8	30
Sweep	12.5mm/s		
Amplitude	Low		

## C.12 C.O.

C.O. Settings	ADU	PED	NEO
Alarm Switch	On		
Alarm Record	Off		
Alarm Level	Medium		
Alarm High Limit (TB)	43.0	43.0	43.0
Alarm Low Limit (TB)	23.0	23.0	23.0
Injective Temperature Source	Auto		
Temperature Unit	°C		
Interval	30		
Constant	0.542		

## C.13 AG

AG Settings	ADU	PED	NEO
Alarm Switch	On		
Alarm Record	Off		
Alarm Level	Medium		
Work Mode	Measure		
Apnea Time	20s		
Unit	%		
O <sub>2</sub> Compensate	OFF		
Anes Agent	HAL		
Alarm High Limit (EtAA)	8.0	8.0	8.0
Alarm Low Limit (EtAA)	0.0	0.0	0.0
Alarm High Limit (FiAA)	6.0	6.0	6.0
Alarm Low Limit (FiAA)	0.0	0.0	0.0
Alarm High Limit (EtN <sub>2</sub> O)	55	55	55
Alarm Low Limit (EtN <sub>2</sub> O)	0	0	0
Alarm High Limit (FiN <sub>2</sub> O)	53	53	53
Alarm Low Limit (FiN <sub>2</sub> O)	0	0	0
Alarm High Limit (EtO <sub>2</sub> )	90.0	90.0	90.0
Alarm Low Limit (EtO <sub>2</sub> )	18.0	18.0	18.0
Alarm High Limit (FiO <sub>2</sub> )	88.0	88.0	88.0
Alarm Low Limit (FiO <sub>2</sub> )	18.0	18.0	18.0
Sweep	12.5mm/s		
Amplitude	2		

## D Abbreviations

Abbr	English Full Name/Description
AC	Alternating current
Adu	Adult
AG	Anaesthesia gas
Art	Arterial
aVF	Left foot augmented lead
aVL	Left arm augmented lead
aVR	Right arm augmented lead
awRR	Airway respiration rate
BP	Blood pressure
BTPS	Body temperature and pressure, saturated
CI	Cardiac index
C.O.	Cardiac output
CISPR	International Special Committee on Radio Interference
CMS	Central monitoring system
CO <sub>2</sub>	Carbon dioxide
COHb	Carboxyhemoglobin
CVP	Central venous pressure
DC	Direct current
Des	Desflurane
Dia	Diastolic
ECG	Electrocardiogram
EEC	European Economic Community
EMC	Electromagnetic compatibility
EMI	Electromagnetic interference
Enf	Enflurane
ESU	Electrosurgical unit
Et	End-tidal
EtCO <sub>2</sub>	End-tidal carbon dioxide
EtN <sub>2</sub> O	End-tidal nitrous oxide

Eto	Ethylene oxide
EtO <sub>2</sub>	End-tidal oxygen
FDA	Food and Drug Administration
Fi	Fraction of inspired
FiCO <sub>2</sub>	Fraction of inspired carbon dioxide
FiN <sub>2</sub> O	Fraction of inspired nitrous oxide
FiO <sub>2</sub>	Fraction of inspired oxygen
Hal	Halothane
Hb	Hemoglobin
Hb-CO	Carbon mono-xide hemoglobin
HR	Heart rate
IBP	Invasive blood pressure
ICP	Intracranial pressure
ICU	Intensive care unit
ID	Identification
IEC	International Electrotechnical Commission
IEEE	Institute of Electrical and Electronic Engineers
Iso	Isoflurane
LA	Left arm
LAP	Left atrial pressure
LCD	Liquid crystal display
LED	Light emitting diode
LL	Left leg
MAP	Mean arterial pressure
MDD	Medical Device Directive
MetHb	Methemoglobin
MRI	Magnetic resonance imaging
N/A	Not applied
N <sub>2</sub>	Nitrogen
N <sub>2</sub> O	Nitrous oxide
Neo	Neonate
NIBP	Non-invasive blood pressure



O <sub>2</sub>	Oxygen
oxyCRG	Oxygen cardio-respirogram
PA	Pulmonary artery
PAWP	Pulmonary artery wedge pressure
Ped	Pediatric
Pleth	Plethysmogram
PR	Pulse rate
PVC	Premature ventricular complex
R	Right
RA	Right arm
RAP	Right atrial pressure
Resp	Respiration
RHb	Reduced hemoglobin
RL	Right leg
RR	Respiration Rate
Sev	Sevoflurane
SYS	Systolic pressure
TB	Blood Temperature
TD	Temperature difference
TEMP	Temperature
USB	Universal serial bus

P/N: 01.54.455711-13

**EDAN**

[www.edan.com.cn](http://www.edan.com.cn)

EC REPRESENTATIVE

Shanghai International Holding Corp. GmbH (Europe)

Eiffestrasse 80, D-20537 Hamburg Germany

TEL: +49-40-2513175 FAX: +49-40-255726

E-mail: [antonjin@yahoo.com.cn](mailto:antonjin@yahoo.com.cn)

EDAN INSTRUMENTS, INC.

3/F-B, Nanshan Medical Equipments Park, Nanhai Rd 1019#,

Shekou, Nanshan Shenzhen, 518067 P.R. CHINA

Email: [info@edan.com.cn](mailto:info@edan.com.cn)

TEL: +86-755-2689 8326 FAX: +86-755-2689 8330