

# Welch Allyn TM286 Auto Tymp

---

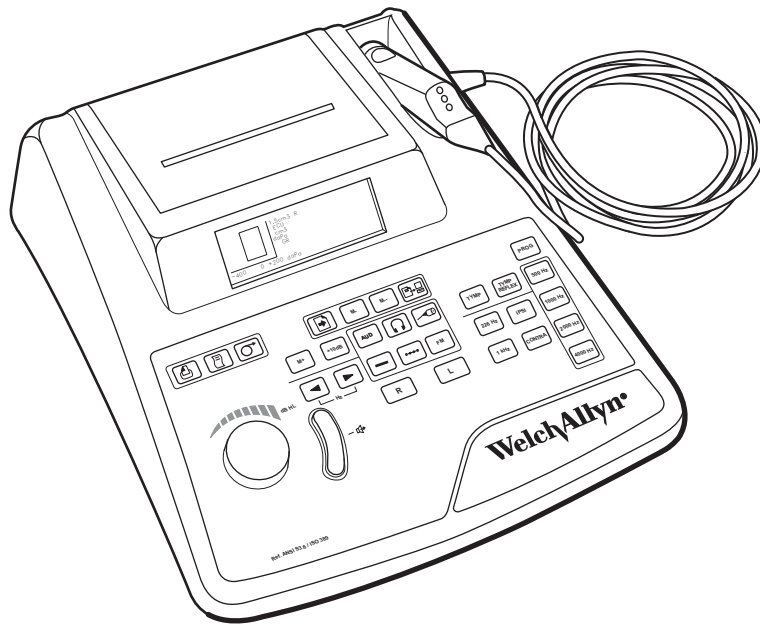

---

## Directions for use

Part Number 28603 Rev D

**WelchAllyn**<sup>®</sup>

Advancing Frontline Care<sup>™</sup>

©2011 Welch Allyn. All rights are reserved. To support the intended use of the product described in this publication, the purchaser of the product is permitted to copy this publication, for internal distribution only, from the media provided by Welch Allyn. No other use, reproduction, or distribution of this publication, or any part of it, is permitted without written permission from Welch Allyn. Welch Allyn assumes no responsibility for any injury to anyone, or for any illegal or improper use of the product, that may result from failure to use this product in accordance with the instructions, cautions, warnings, or statement of intended use published in this manual.

Welch Allyn is a registered trademark of Welch Allyn.

Software in this product is Copyright 2010 Welch Allyn or its vendors. All rights are reserved. The software is protected by United States of America copyright laws and international treaty provisions applicable worldwide. Under such laws, the licensee is entitled to use the copy of the software incorporated with this instrument as intended in the operation of the product in which it is embedded. The software may not be copied, decompiled, reverse-engineered, disassembled, or otherwise reduced to human-perceivable form. This is not a sale of the software or any copy of the software; all right, title, and ownership of the software remain with Welch Allyn or its vendors.

For information about any Welch Allyn product, call Welch Allyn Technical Support:

Tel.: 1-800-535-6663 (In U.S.A. only)

Tel.: 1-800-561-8797 (in Canada only)

**REF 28603 (Printed, English only)**  
**28603 Rev D, 2011-01**

### Compliance

The CE0344 mark identifies compliance with the Medical Device Directive 93/42/EEC. Grason-Stadler is an ISO 13485-certified corporation.



Manufactured for Welch Allyn by



Grason-Stadler  
7625 Golden Triangle Drive  
Suite F  
Eden Prairie, MN 55344  
[www.grason-stadler.com](http://www.grason-stadler.com)

Welch Allyn, Inc.  
4341 State Street Road  
Skaneateles Falls, NY 13153-0220 USA

[www.welchallyn.com](http://www.welchallyn.com)

1 - Introduction . . . . .	1
Unpacking and inspection . . . . .	1
Supplied Accessories . . . . .	1
Optional Accessories . . . . .	2
Recycling / disposal . . . . .	2
Safety Summary . . . . .	2
Warranty . . . . .	4
Tympanometry and Gradient . . . . .	4
2 - Installation . . . . .	9
Printer and Display . . . . .	9
Rear Panel Labels and Connectors . . . . .	10
Bottom Panel . . . . .	11
3 - Operation . . . . .	15
226 Hz Probe Indicators . . . . .	15
Front Panel Controls and Indicators . . . . .	16
4 - Program Mode . . . . .	33
Program Mode Menu Items . . . . .	33
Program Menu Page 1 Option Descriptions . . . . .	34
Program Menu Page 2 Option Descriptions . . . . .	40
5 - Routine Maintenance . . . . .	43
PreTest Tymp checks . . . . .	43
6 - Test Results . . . . .	51
Ear Canal Volume - Tympanometry . . . . .	51
Compliance Peak . . . . .	51
Pressure Peak . . . . .	52
Gradient . . . . .	52
Acoustic reflex . . . . .	53
Audiometry . . . . .	53
Sample Test Results . . . . .	54
7 - Computer Interface . . . . .	57
Introduction . . . . .	57
Operation . . . . .	57
8 - Standards, Specifications, and Accessories . . . . .	61
Standards and Compliance . . . . .	61
Tympanometry modes . . . . .	61
Pneumatic System . . . . .	62
Acoustic Reflex Stimuli . . . . .	62
Probe LED Indicators . . . . .	63
Audiometry mode . . . . .	63
Transducers . . . . .	63

Intensity Levels . . . . . 63  
Tone Format . . . . . 64  
Printer . . . . . 64  
Power . . . . . 64  
Environmental . . . . . 64  
Mechanical . . . . . 65  
Head set . . . . . 65  
Electromagnetic Compatibility . . . . . 65  
Accessories . . . . . 66  
Bibliography . . . . . 67

## 1

# Introduction

---

The TM286 Auto Tympanometer (hereafter referred to as 'instrument' in this guide unless otherwise noted for clarity) is a versatile combination instrument that provides testing capability for tympanometry alone, tympanometry combined with screening acoustic reflex measurements, and screening audiometry.

An optional soft-sided carrying case is available for portability. Also, a patient handswitch, patch cords, and earphone sound enclosures may be purchased as optional accessories.

## Unpacking and inspection

Examine the outside of the shipping container for any signs of damage. Notify the carrier immediately if any damage is noted.

Carefully remove the TM286 Auto Tympanometer from its shipping container. If the instrument appears to have suffered mechanical damage, notify the carrier immediately so that a proper claim can be made. Be certain to save all packing materials so that the claim adjuster can inspect it as well. As soon as the carrier has completed the inspection, notify a Welch Allyn representative.

If the instrument must be returned, repack it carefully (in the original TM286 Auto Tympanometer container if possible) and return it prepaid to Welch Allyn for necessary adjustments.

**Note** Keep the original packing material and shipping container so the instrument can be well packaged if it needs to be returned to the local service center for repair or calibration.

## Supplied Accessories

Check that all accessories itemized in Supplied Accessories below are received in good condition. If any accessories are missing, contact Welch Allyn immediately. See ["Accessories"](#) on page 66 and the listings below for the catalog numbers of accessories and also for a listing of optional accessories.

Welch Allyn Part Number	Welch Allyn Description
26100	TM Eartips (6 sizes, 2 each)
26241	TM Test Cavity
28203	DD45 Audiometry Headset External
28206	Threshold Audiometry Card
28600	TM286 Probe Assembly
28601	TM286 Power Brick (113-405800)

28602	TM286 Cord, Power, Hosp Grade
28603	TM286 Directions for Use Manual (printed, English only)
28604	TM286 Quick Reference Guide
28605	TM286 Directions for Use Manual (printed, French only)
28607	TM Wall Chart for Tympanometer tracings
52600*	Thermal Paper 4" wide (3 rolls shipped with system)

\* Note: To reorder paper, use the 52600 part number.

## Optional Accessories

26240	TM Dust Cover
05260-U	TM Carrying Case
23221	Audiometry Single Patch Cord, 2-Conductor
23220	Audiometry Patient Response Switch
23222	Audiometry AudioCups



**WARNING** To ensure patient safety and optimal product performance, use only Welch Allyn recommended accessories and supplies.

**WARNING** The use of parts or materials that are not recognized to be used with the device can degrade minimum safety.

## Recycling / disposal



**Caution** Many local laws and regulations require special procedures to recycle or dispose of electric equipment-related waste including batteries, printed circuit boards, electronic components, wiring and other elements of electronic devices. Follow all of your respective local laws and regulations for the proper disposal of batteries and any other parts of your system.

## Safety Summary

Before using the TM286 Auto Tympanometer, familiarize yourself with the sections of this directions for use that pertain to your use of the TM286 Auto Tympanometer.

- Failure to understand and observe any warning statement in this manual could lead to patient injury, illness, or death.
- Failure to understand and observe any caution statement in this manual could lead to damage to the device or other property, or loss of patient data.



**WARNING** Warnings indicate conditions or practices that could lead to illness, injury, or death.



**Caution** Cautions indicate conditions or practices that could damage the equipment or other property.

**Note** Notes help you identify areas of possible confusion and avoid potential problems during system operation

## Safety Notes



**WARNING** The TM286 is designed to be used with a hospital grade outlet. Injury to personnel or damage to equipment can result when a three-prong to two-prong adapter is connected between the TM286 power plug and an AC outlet or extension cord.

Additionally, the TM286 is equipped with a specific power transformer, (113-405800, reorder number 28601), which should not be interchanged with any other transformer or supply.

**WARNING** The TM286 is a specifically calibrated device and the periodic service and adjustments, which the instrument may require, should be done only by an authorized Welch Allyn service technician.

**WARNING** The TM286 Auto Tympanometry is designed for compliance to IEC and UL 60601-1 when used in the patient vicinity. To achieve this compliance, use of hospital grade plug and receptacles are required. For patient and operator safety, the TM286 must be used with properly grounded plug and receptacles at all times. The TM286 is equipped with a specific power transformer (113-405800, reorder number 28601), which should not be interchanged with any other transformer or supply.

**WARNING** Any program aimed at obtaining reliable records of hearing thresholds should be staffed and supervised by appropriately-trained individuals.

**WARNING** This symbol ▼ indicates the location of a service adjustment part and is intended for service personnel only. The TM286 is a specifically calibrated audiometer and the periodic service and adjustments for the instrument that may be required should be done only by an authorized service technician.

**WARNING** Please read the entire manual prior to using the TM286 to become familiar with the test functions and proper accessory connections.

**WARNING** Accessory equipment connected to the analog and digital interfaces must be certified to the respective IEC standards (IEC950 for data processing or IEC 60601-1 for medical equipment). Furthermore, all configurations shall comply with the system standard IEC 60601-1-1. Everyone who connects additional equipment to the signal input or signal output port configures a medical system, and is therefore responsible that the system complies with the requirements of the system standard IEC60601-1-1. If in doubt, consult the technical service department or a local Welch Allyn representative.



**Caution** The TM286 is designed to comply with the EMC requirements according to IEC 60601 1-2.

**Caution** Radio transmitting equipment, cellular phones, etc. should not be used in the close proximity of the device since this could influence the performance of the device.

**Caution** Particular caution must be considered during use of strong emission sources such as high frequency surgical equipment and similar devices. If in doubt, contact a qualified technician or a local Welch Allyn representative.

Latex is not used anywhere in the manufacturing process.

The base material for the earphone cushions is made from natural and synthetic rubber.

The material used to manufacture Welch Allyn's eartips is Krayton Thermoplastic Rubber.

## Customer Responsibility



**WARNING** This product and its components will perform reliably only when operated and maintained in accordance with the instructions contained in this manual, accompanying labels, and/or inserts. A defective product should not be used. Make sure all connections to external accessories are snug and secured properly. Parts which may be broken or missing or are plainly worn, distorted or contaminated should be replaced immediately with clean, genuine replacement parts manufactured by or available from Welch Allyn.

**WARNING** This product should not be used in the presence of fluid that can come into contact with any of the electronic components or wiring. Should the user suspect fluids have contacted the system components or accessories, the unit should not be used until deemed safe by a Welch Allyn certified service technician.

**WARNING** Do NOT use in the presence of flammable gaseous mixtures. Users should consider the possibility of explosions or fire when using this device in close proximity to flammable anesthetic gases.

**WARNING** Have a service technician periodically perform electrical safety checks on the unit in order to show continued compliance to IEC and UL 60601-1.

## Warranty

We, Welch Allyn, warrant that this product is free from defects in material and workmanship, and when properly installed and used, will perform in accordance with applicable specifications. If within one year after original shipment it is found not to meet this standard, it will be repaired, or at our option, replaced at no charge except for transportation costs, when returned to an authorized product service facility.

**Note** Changes in the product not approved in writing by Welch Allyn shall void this warranty. Welch Allyn shall not be liable for any indirect, special or consequential damages, even if notice has been given in advance of the possibility of such damages.

THIS WARRANTY IS IN LIEU OF ALL OTHER WARRANTIES, EXPRESS OR IMPLIED, INCLUDING BUT NOT LIMITED TO, ANY IMPLIED WARRANTY OF MERCHANTABILITY OF FITNESS FOR A PARTICULAR PURPOSE.

## Tympanometry and Gradient

Tympanometry provides an objective means for determining the amount of mobility present within the eardrum and the ossicular chain. It is, however, important to keep in mind the fact that the amount of mobility present within the ossicular chain may be camouflaged by a scarred or thickened eardrum.



Acoustic energy, commonly referred to as the probe tone (226 Hz) is introduced into a hermetically sealed ear canal by means of a loudspeaker located within the probe. The intensity of this tone is monitored via a microphone, also located within the probe box. Measurements are taken at fixed time intervals.

As pressure within the ear canal is varied, the eardrum is subjected to varying degrees of stress which alters the mobility of the eardrum. Maximum mobility will occur when the pressure on both sides of the eardrum are equal. Changes in mobility of the eardrum tend to produce changes in the probe tone level within the ear canal. Probe tone intensity changes indicate the amount of sound energy entering the middle ear.

Compliance is calculated based on these measurements. Since the sound pressure level of the probe tone within the ear canal varies as a function of mobility, it is possible to record these changes in mobility as a function of pressure. While the recording is visualized in the horizontal direction (X-axis) as a function of differential pressure across the eardrum, the tracing also moves in the vertical direction (Y-axis) as a function of mobility or admittance of the middle ear system. A graphic presentation of this information is known as a tympanogram.

The point of the tympanogram which represents the point of maximum compliance is the compliance peak of the tympanogram. The air pressure (pressure at the peak) where this compliance peak occurs approximates the pressure within the middle-ear system, since maximum mobility is only possible when there is little or no pressure difference between the ear canal and the middle-ear space. Compliance using a 226 Hz probe tone is measured with respect to the ability of an equivalent volume of air to conduct sound and the scientific quantity used is  $\text{cm}^3$ .

**Note** 1.02 mmH<sub>2</sub>O = 1.0 daPa

The presence of a pathological condition which interferes with the mobility of the tympanic membrane, the ossicular chain, or the air pressure within the middle-ear space can be detected during tympanometry.

- If the air pressure within the middle-ear space becomes negative due to a blocked eustachian tube, tympanometry measures this negative pressure and its effect on middle-ear compliance.
- If fluid builds up within the middle-ear space, this fluid will restrict the ability of the ossicular chain to conduct sound to the cochlea. If small air pockets exist within the fluid, the tympanogram will indicate the negative pressure where the restricted mobility occurs. With a totally fluid-filled middle-ear space, no mobility will be measured during tympanometry at any pressure value.
- In the case of a "glue-ear", the ossicular chain is restricted in mobility. This tympanogram would depict a flat line with no identifiable pressure peak.

## Gradient

Gradient (width) measurements are used to describe the shape of a tympanogram near the peak. Often, the presence or absence of fluid in the middle ear is not clearly indicated by otoscopy and tympanometry alone. This evaluation is especially difficult when the peak pressure is within the normal range.

The presence of fluid within the middle-ear space alters the shape of a tympanogram (i.e., makes the tympanogram wider near its peak). A larger-than-normal gradient can indicate the presence of fluid in the middle ear when other parameters are within normal limits. In this way, the gradient acts as an adjunct to the tympanogram and ear canal volume

measurements by helping to differentiate between tympanograms with similar peak values.

The instrument uses tympanometric width to determine the gradient by measuring the pressure interval at one-half of the tympanogram peak height. Differing tympanogram peak widths can point to different middle-ear conditions, even when peak height and pressure are within normal range. For example, middle-ear effusion caused by secretory otitis media many result in an increased tympanogram width and, therefore, an increased gradient value. This would occur because the ossicular chain cannot react to the change in pressure introduced during the tympanogram in the same way that it would if the middle ear were properly aerated. The continued presence of effusion, leading eventually to a completely fluid filled middle-ear cavity, will reduce the magnitude of the tympanogram to the point where no change in compliance is detectable across the pressure range. Under this condition, no gradient measurement is possible.

On the TM286, gradient measures are calculated for the 226 Hz probe tone conditions.

## Screening acoustic reflex

An acoustic reflex occurs when a very loud sound (stimulus) is presented to the auditory pathway. During acoustic reflex testing, the stimulus is presented to the ear canal through a probe (ipsilateral). This stimulus then travels through the middle ear to the cochlea. From the cochlea, frequency and intensity information is transmitted via the 8th nerve to the brain stem where a determination is made as to whether or not the intensity of the stimulus is high enough to elicit a reflex response. If it is, a bilateral response occurs (i.e., the right and left 7th nerves innervate their respective middle-ear muscles (stapedial muscles) causing them to contract). As these muscles contract, they stiffen their respective ossicular chains. This stiffening of the ossicular chain reduces the compliance of each middle-ear system.

When the stimulus is presented to the same ear as the measurement, the test is referred to as an ipsilateral (same side) acoustic reflex test.

During ipsilateral acoustic reflex testing, both the stimulus and the probe tone are presented via the hand-held probe. In both cases, the measurement is made from the ear where the probe is positioned. For 226 Hz probe tone reflex measurements, the air pressure within the ear canal where the probe is positioned is set to the pressure value measured at the point of maximum compliance for that ear during tympanometry with an offset of -20 daPa (or +20 daPa for a positive pressure peak).

Acoustic reflex measurements are useful to determine the integrity of the neuronal pathway involving the 8th nerve, brainstem, and the 7th nerve. Since the acoustic reflex test is performed at high intensity levels and since it involves a measurement of middle-ear mobility, acoustic reflex testing is not a test of hearing.

The acoustic reflex also serves as a good validation of tympanometric results since an acoustic reflex cannot be measured in the absence of a compliance peak. In other words, if the tympanometric results indicate no mobility over the pressure range available, no reflex will be observed. If the test results indicate a reflex response in the absence of a compliance peak, one has cause to question the validity of the tympanometric test results. This indicates that the tympanogram should be repeated.

Clinical middle-ear instruments allow the measurement of the acoustic reflex threshold since they provide the ability to manually change the intensity of the stimulus to a level where a reflex response is just barely detectable for each patient tested. However, this screening instrument automatically presents the stimulus in a very definite stimulus intensity sequence. This preset intensity sequence may start at a level above an

individual's acoustic reflex threshold level. Also, since the instrument uses a hand-held probe and noise from hand motion can be detected by the instrument's circuitry, the magnitude of a detectable response must be somewhat higher than the criterion generally used during clinical acoustic reflex threshold testing to avoid artifact caused by hand motion. The acoustic reflex measurements made with this instrument are referred to as screening acoustic reflex testing. The purpose of these screening reflex tests is to determine whether a reflex is detectable rather than to determine the lowest intensity at which the reflex occurs (i.e., threshold testing).

## Screening audiometry

While tympanometry and acoustic reflex measurements check the integrity of the middle-ear system, audiometry provides a means for checking the integrity of the entire auditory pathway. Screening audiometry provides a method to determine an individual's ability to hear a test signal at a particular intensity level or at the lowest possible intensity level without the use of masking.

During screening audiometry, the test signal is generally presented through an earphone to the ear. Different screening test protocols define the frequencies and intensity sequence to be used to obtain a response. Audiometric testing requires a behavioral response from the individual being tested. This consists of having the individual raise a finger/hand or press a handswitch (optional) whenever the test signal is heard. The finger/hand is lowered or the handswitch is released when the test signal is no longer audible. The individual being tested must be able to understand a set of simple instructions and have the ability to provide some physical sign when the test signal is heard.

The TM286 allows for both manual and automated audiometry. For further details on automated audiometry, see ["Automatic Hearing Level"](#) on page 29 of this guide.

## Glossary of terms

<b>Acoustic Reflex</b>	Reflexive contraction of the stapedius muscle in response to loud sound.
<b>Automated Audiometry (Auto HL)</b>	Automated measurement of hearing that allows the listener to control the intensity with a hand switch.
<b>Compliance Peak</b>	The point of maximum mobility in a tympanogram, which indicates the degree of mobility within the middle-ear system.
<b>Ear Canal Volume</b>	Volume measured between the tip of the probe and the tympanic membrane at the starting pressure for a tympanogram using a 226 Hz probe tone.
<b>Ipsilateral Acoustic Reflex</b>	The acoustic reflex elicited when the stimulus is presented to the same ear where the response is measured.
<b>Normal Box</b>	Range of pressure peak and compliance peak values associated with normal middle-ear function. (-150 daPa to +100 daPa, 0.2 cm <sup>3</sup> to 1.4 cm <sup>3</sup> per ASHA, 32, Supl. 2, 1990, 17-24) - only available on 226 Hz probe tone testing.
<b>Pressure Peak</b>	Pressure value where maximum mobility occurs in a tympanogram. This pressure value approximates the pressure within the middle-ear space.
<b>Probe Tone</b>	The pure tone that is held at a constant intensity level in the ear canal - assists in the measurement of middle ear function.
<b>Screening Audiometry</b>	Rapid assessment of the ability of individuals to hear acoustic signals across a frequency range at a fixed criterion intensity level; designed to identify those who require additional audiometric procedures.
<b>Tympanogram</b>	Graph of the middle ear immittance as a function of the amount of air pressure delivered to the ear canal.
<b>Tympanometry</b>	Procedure used in the assessment of middle ear function in which the immittance of the tympanic membrane and middle ear is measured as air pressure delivered to the ear canal is varied.

# 2 Installation

## Printer and Display

Figure 1. TM286 major component identifications

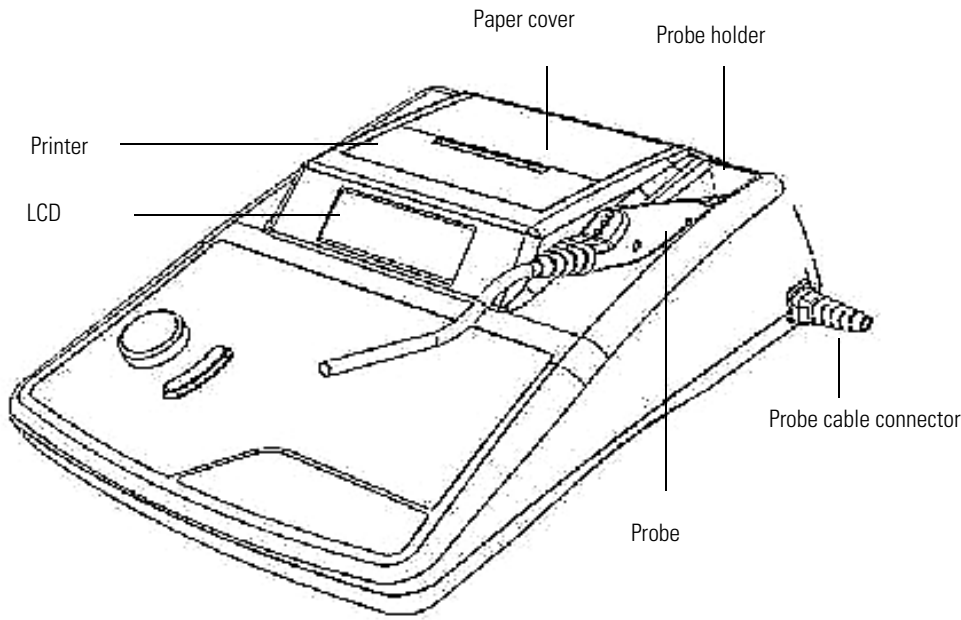
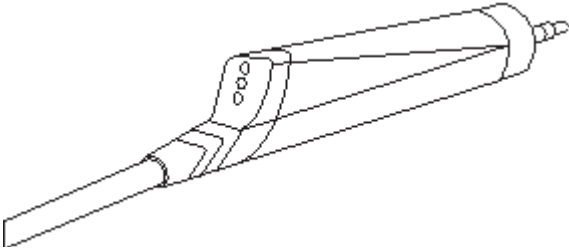
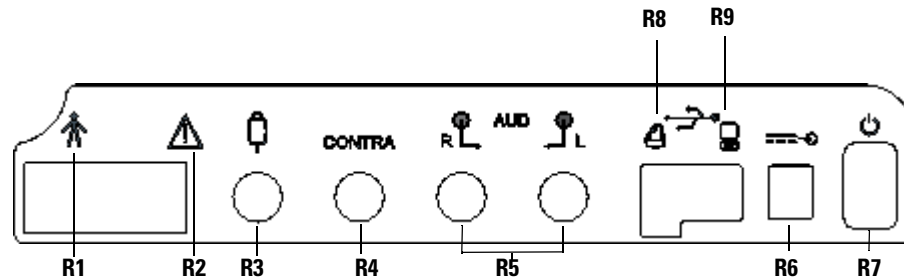

Figure 2. Probe



## Rear Panel Labels and Connectors

Figure 3. Rear panel labels and connectors



- R1** Symbol denotes a Type B
- R2** Symbol denotes Attention, consult accompanying documents
- R3** Connector for handswitch (Optional)
- R4** Connector for contralateral insert phone (Not Available)
- R5** Connectors for right and left earphone
- R6** Power Input Jack for external power supply
- R7** Power Switch with ON/OFF indicators
- R8** USB port for connecting to an external printer
- R9** USB port for connecting to a computer



**WARNING** Accessory equipment connected to the analog and digital interfaces must be certified to the respective IEC standards (IEC 950 for data processing or IEC 60601-1 for medical equipment). Furthermore, all configurations shall comply with the system standard IEC 60601-1-1. Everyone who connects additional equipment to the signal input or signal output part configures a medical system, and is, therefore, responsible that the system complies with the requirements of the system standard IEC 60601-1-1. If in doubt, consult Welch Allyn at Tel.: 1-800-535-6663 (In U.S.A. only) or Tel.: 1-800-561-8797 (in Canada only).



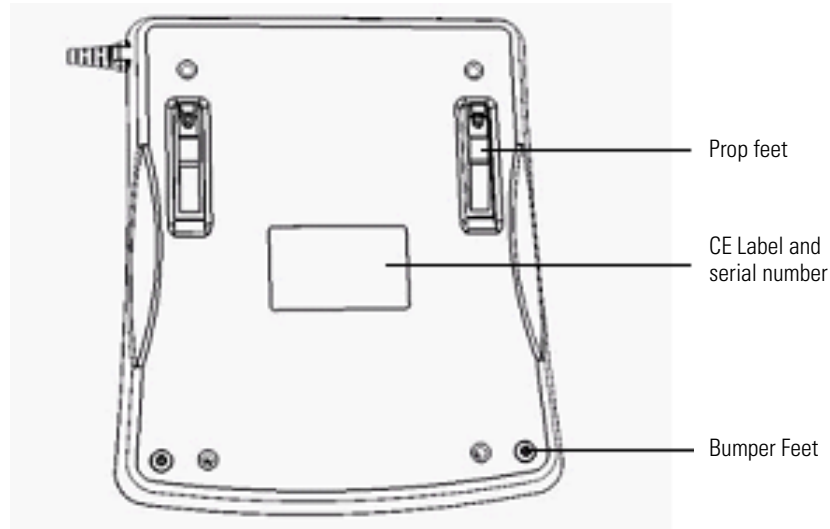

# Bottom Panel

**Figure 4. Bottom panel**



## Symbols on the TM286 Auto Tym

Symbol	Description
	Attention, consult accompanying documents.
	Date of manufacture
	CE Marked in accordance with the European Council Directive 93/42/EEC concerning medical devices
	Special Recycling Required. Do not dispose in landfill.
	Type B equipment
<b>REF</b>	Symbol for "CATALOG NUMBER"
	Stand-by
	Right Ear
	Left Ear

Symbol	Description
	Patient Response Button
	AC Power
	Printer Connector
	USB Type Connectors
	Computer Connector

## Initial set-up

Place the instrument on a stable counter or table where it will be used. The location should be near a properly grounded wall outlet. Carefully attach purchased accessories to their appropriately labeled connector on the rear panel of the instrument (see [“Rear panel labels and connectors”](#) on page 10).

Locate the power switch on the rear panel of the instrument and move the switch to the On position. When power is turned on, the light on the LCD will be illuminated and the orange light on the probe will be lit. The display on the LCD will display a scroll bar across the top to indicate the system is initializing.

The system will power up to the factory default test mode (to set user-defined power up setting, see [“Program Mode”](#) on page 33) and the probe green lamp will begin to blink indicating that the instrument is ready to begin the testing. If both the green and yellow lamps are illuminated at the same time following power on, the probe is occluded or the tympanogram software did not initialize properly. Simply move the power switch to the off position, inspect the probe tip for any signs of an occlusion, and reposition the power switch to On. If both green and yellow lamps are still illuminated and the probe is not occluded, contact a local service representative or the Welch Allyn service department for repair. In the mean time, it is still possible to use the Audiometry mode (if purchased).

Allow the instrument to warm-up for about 10 minutes before conducting a test. This allows the electronic circuits to stabilize prior to use. If the storage temperature is lower than the room temperature, allow additional time for the instrument to reach room temperature.





**Caution** Use only the provided power supply. The TM286 Auto Tym provided power supply should only be connected to a power source meeting the following range: 90-246VAC, 47-63Hz. In North America, the power source should be a maximum of 120VAC.

## Loading the paper

Remove the printer cover by placing fingers along the back edge of the printer and pulling upward on the cover. Cut the printer paper so that the leading edge of paper is straight across. Place the roll of paper inside the paper well so that the paper will unroll from the lower surface. See the paper loading label located on the side of the paper well.

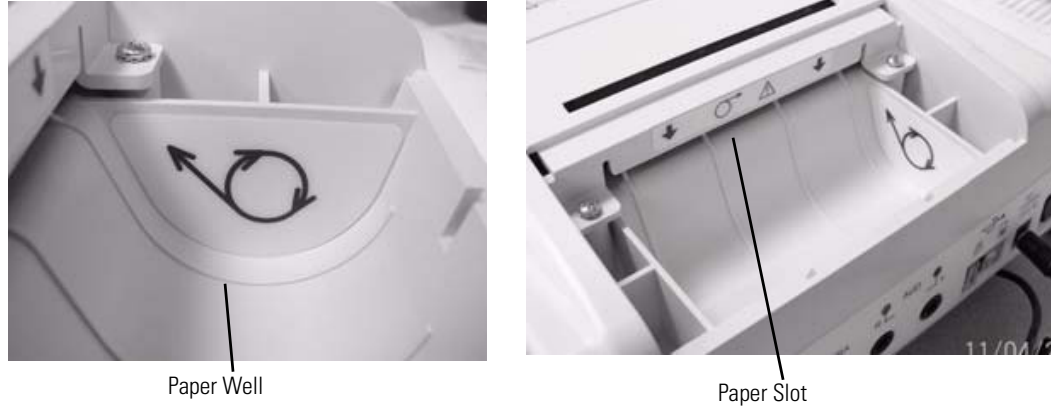

**Figure 5. Paper loading**

Position the leading edge of the paper roll into the paper slot. Press the paper advance button  until a section of paper is long enough to pass through the printer cover.

## Paper storage

The instrument is supplied with a thermal printer. This type of printer requires a heat-sensitive paper to create an image. For maximum paper life, any spare rolls of paper should be stored as follows:

- a. Store in the dark (i.e., in a drawer or cabinet)
- b. Do not store above 77° F (25° C)
- c. Store at less than 65% relative humidity

The above recommendations are for the maximum paper life (greater than five years). Storing thermal paper at high temperatures or high humidity levels will shorten the total paper life. The paper will show some darkening if stored for 24 hours at 113° F (45° C) and a relative humidity of greater than 90%. Avoid leaving paper in a hot car or other hot area overnight. Always avoid storing unused paper or printed tests in a lighted area.



# 3 Operation

## 226 Hz Probe Indicators

**Figure 6. Probe indicators**

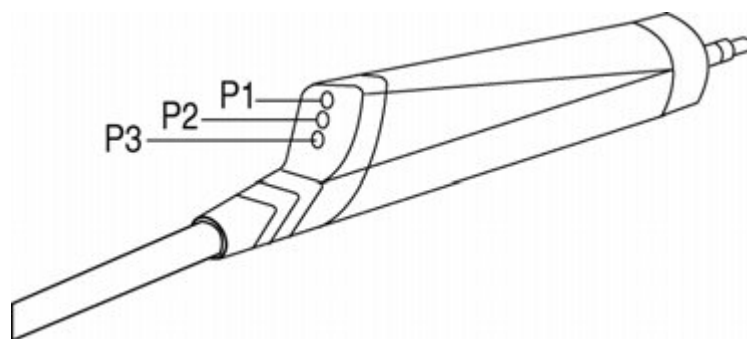

- |                         |   |
|-------------------------|---|
| <b>P1 - Yellow:</b>     | The probe is occluded. Remove the probe and inspect for cause of occlusion.                                   |
| <b>P2 - Green lamp:</b> | Blinking - The instrument is ready to begin a Tymp. Steady green - Test successfully started and in progress. |
| <b>P3 - Orange:</b>     | A pressure leak has been detected.  |

When doing a 226 Hz probe tone test, use the White Flat tips, 26100. The 226 Hz probe tone test auto-starts the pressure sequence and placing the probe in the ear canal when the pressurization begins can result in unwanted deflections in the tympanogram. The White Flat ear tips allow the user to place the probe and hold the Probe Tip at the entrance to the patient's ear canal while the tympanogram and reflex testing are performed.









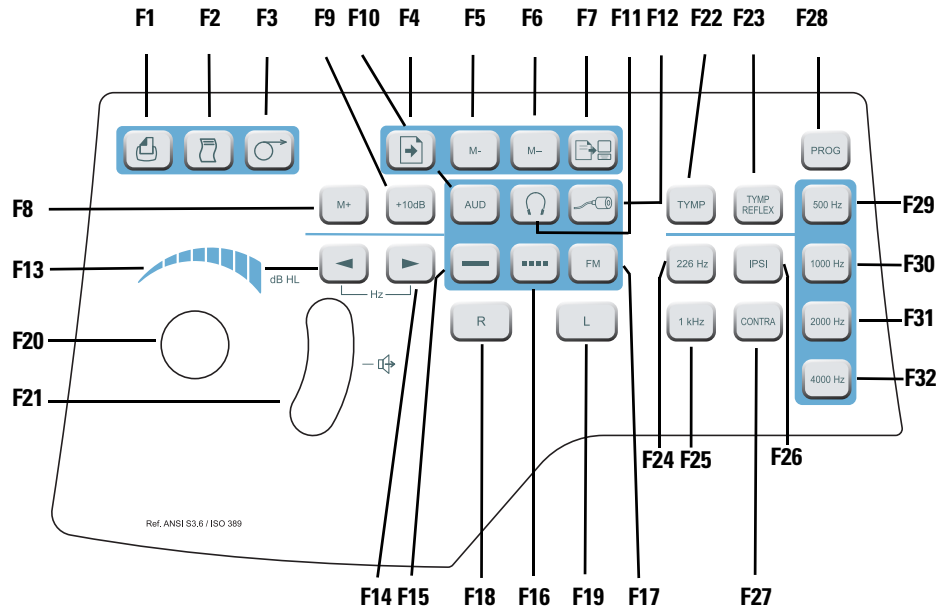







**WARNING** A Welch Allyn provided Probe Tip must be used. Using the probe without the Probe Tip could result in injury to the subject.

# Front Panel Controls and Indicators

Figure 7. Front panel



Legend / Label	Button	Description
<b>F1 / Print Screen</b>		Used to print the currently displayed page of memory or active test screen.
<b>F2 / Print All Memory</b>		Used to print all pages of data from memory.
<b>F3 / Paper Advance</b>		Causes paper to feed through printer; may be used to load paper or to provide space between printouts.
<b>F4 / PAGE</b>		Enters Page Mode: Pressing <b>F13</b> and <b>F14</b> scrolls through the test results stored in memory.
<b>F5 / M -</b>	<b>M -</b>	Erases currently displayed page of data from memory.
<b>F6 / M - -</b>	<b>M - -</b>	Erases all pages of data from memory.
<b>F7 / Data Transfer</b>		Transfers test results to an attached computer.

Legend / Label	Button	Description
<b>F8 / M+</b>	<b>M +</b>	Save button; during <b>Audiometry</b> mode, saves threshold information per frequency on the display; during <b>Program</b> mode, selects highlighted option.
<b>F9 / +10 dB</b>	<b>+10dB</b>	Used to temporarily extend the intensity range by 10 dB; a large + sign appears on the display indicating that the extended range has been selected.
<b>F10 / Aud(iometry)</b>	<b>AUD</b>	Selects Audiometry mode. When in Audiometry, this button starts the Auto HL when held for 3 seconds.
<b>F11 / Headphone</b>		Selects the calibration file for external headset transducers. When the  button is pressed, the display will flash. Press the  button again to engage the external headset transducer. The symbol  is shown on the right side of the display when selected.
<b>F12 / Insert</b>		Selects internal earphone calibration file for transducers. When the button  is pressed, the display will flash. Press the  button again to engage the internal earphone transducers. The symbol  is shown on the right side of the display when selected.
<b>F13 and F14 / Decrease and Increase Frequency</b>	 	Selecting  advances the presentation tone to the next lower frequency; selecting  advances the presentation tone to the next higher frequency.
<b>F15 / Steady</b>		Used during Audiometry mode to select a continuous test tone when Present Bar is depressed; the steady symbol appears on the display.
<b>F16 / Pulsed</b>		Used during Audiometry mode to select a pulsed tone when the Present Bar is depressed; the pulsed symbol appears on the display.
<b>F17 / FM</b>	<b>FM</b>	Used during Audiometry mode to select a frequency modulated test tone when the Present Bar is depressed; the letters <b>FM</b> appears on the display when selected.
<b>F18 / R</b>	<b>R</b>	Used to indicate the right ear is the test ear; so data stored in memory and/or printed is properly identified. An <b>R</b> will appear on the LCD.
<b>F19 / L</b>	<b>L</b>	Used to indicate the left ear is the test ear; so data stored in memory and/or printed is properly identified. An <b>L</b> will appear on the LCD.
<b>F20 / Attenuator Knob (dB HL)</b>		Used to increase or decrease the intensity of the test tone presented in Audiometry mode; counterclockwise rotation decreases the rotation; clockwise rotation increases the intensity.
<b>F21 / Present Bar</b>		In Audiometry mode, used to present test signal to appropriate earphone; release to turn test tone off.
<b>F22 / TYMP</b>	<b>TYMP</b>	Selects <b>Tympanometry only</b> mode.

Legend / Label	Button	Description
<b>F23 / Tymp Reflex</b>	<b>TYMP REFLEX</b>	Selects <b>Tympanometry</b> and <b>Reflex</b> mode.
<b>F24 / 226Hz</b>		Selects 226 Hz for Probe Tone Frequency.
<b>F25 / 1KHz</b>		Not available with the 226 Hz Probe Tone.
<b>F26 / IPSILATERAL</b>		Selects an ipsilateral reflex test.
<b>F27 / CONTRALATERAL</b>		Not available with the 226 Hz Probe Tone.
<b>F28 / Prog(ram)</b>		Selects Program mode screen which lists settings available for reflex presentation format, printout header format, audiogram vs. tabular format, display normal box, and identify frequency range for Audiometry mode.
<b>F29 / 500</b>		Selects 500 Hz as a stimulus during reflex testing.
<b>F30 / 1000</b>		Selects 1000 Hz as a stimulus during reflex testing.
<b>F31 / 2000</b>		Selects 2000 Hz as a stimulus during reflex testing.
<b>F32 / 4000</b>		Selects 4000 Hz as a stimulus during reflex testing.

The figures **226 Hz Tympanometry screen**, **226 Hz Tympanometry/Reflex screen**, and **Audiometry screen** show the individual display format for each test mode.

**Figure 8. 226 Hz Tympanometry screen**

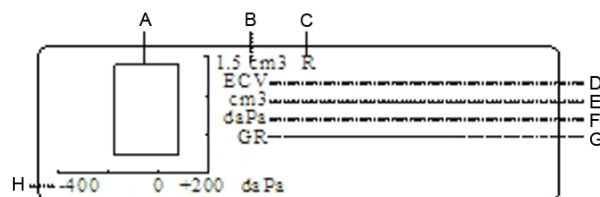

- A** ASHA Box
- B** Scale of Tympanogram Compliance
- C** Test Ear
- D** Ear Canal Volume
- E** Peak Amplitude
- F** Pressure at peak
- G** Gradient/Tympanogram width
- H** Pressure sweep scale in daPa

**Figure 9. 226 Hz Tympanometry/Reflex screen**

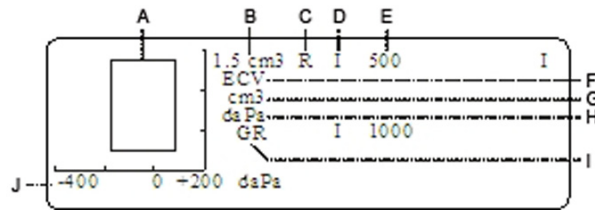

- A** ASHA Box
- B** Scale of Tympanogram Compliance
- C** Test Ear
- D** Reflex Stimulation Routing (IPSILATERAL)
- E** Frequency of Reflex Stimulus
- F** Ear Canal Volume
- G** Peak Amplitude
- H** Pressure at peak
- I** Gradient/Tympanogram Width
- J** Pressure Sweep Scale in daPa

**Figure 10. Audiometry screen**

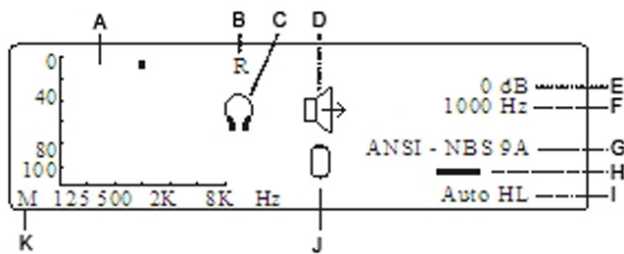

- A** Audiogram Display
- B** Test Ear
- C** Test Headset selected (make certain the correct earphones are plugged in for this selection)
- D** Indicates Signal is being presented when displayed
- E** Current Stimulus Intensity
- F** Current Stimulus Frequency
- G** Calibration information and earphone coupler
- H** Tone Type Indicator
- I** Indicates Auto HL procedure is in progress when displayed
- J** Patient Response Switch (optional accessory) is being pressed
- K** M indicates manual testing  
A indicates automatic testing

## Tympanometry testing information

It is good practice to perform a test on a normal ear each day to make certain that the instrument is functioning properly. See [“Biological Check”](#) on page 46 for details.

### Helpful hints

Tympanometry and acoustic reflex testing can be performed on patients of any age; however, the technique used will vary with age. From three years through adult, tympanometry can be performed with little difficulty due to the cooperative nature of this age group. With patients under three years old, a bit of ingenuity is required to keep the patient relatively quiet during the seconds required for the test. In all cases, distraction is the key to success. Anything that provides a sound and/or visual distraction should work.

Sucking on a pacifier or a bottle will help with the younger population. However, the tympanogram tracing will not appear as smooth due to the movement artifact. Having a parent hold an infant during testing will also help. For the 1000 Hz probe tone on infants, we recommend turning the **Auto Start** option off (factory default setting). This will allow the probe to be positioned and will allow repeated tests without removing the probe.

The key to success in all cases is to be at eye level with the ear canal. Use a steady hand monitor the ear canal and probe lights until the test is over. It is a good idea upon first receiving the instrument to practice on a cooperative patient to gain confidence in its use.

## Obtaining a seal



**WARNING** A Welch Allyn provided Probe Tip must be used. Using the probe without the Probe Tip could result in injury to the subject.

Six different size eartips are provided with this instrument. The size of eartip will vary with size of the individual patient. Generally speaking, the following criteria apply:

- Premie - 8 mm (26008)
- Newborn - 8 mm, 11 mm (26011)
- Pre-school -11 mm, 13 mm (26011 or 26013)
- School age -11 mm, 13 mm, 15 mm (26011, 26013, or 26015)
- Adult -15 mm, 17 mm, 19 mm (26015, 26017, or 26019)

**Note** Before attempting to seal the entrance of the ear canal, visually inspect the opening to make sure that the canal is free of any obstruction. If the canal is completely plugged at the entrance or if fluid is running from the ear canal, tympanometry should not be attempted until the condition is cleared.

Damage to the probe can result if fluid is sucked into the probe with negative pressure.

1. Place the appropriate size eartip onto the nose cone of the probe, making sure the rounded tip of the eartip sits flush with the tip of the nose cone (See [“Positioning the eartip”](#) on page 21).

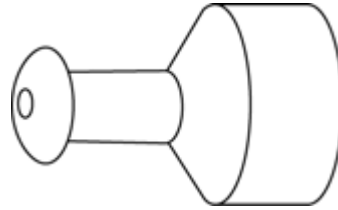

**Figure 11. Positioning the eartip**

2. Move any hair away from the ear and pull up and back on the pinna (pull downward and back on the pinna of a young child.) This will straighten out the ear canal and enable better results. Keep the pinna in this position throughout the test sequence.
3. Make sure that the **green** lamp on the probe is blinking.
4. Position the probe up against the entrance of the ear canal, applying a gentle pressure to maintain a tight seal (See ["Positioning the probe"](#) below).

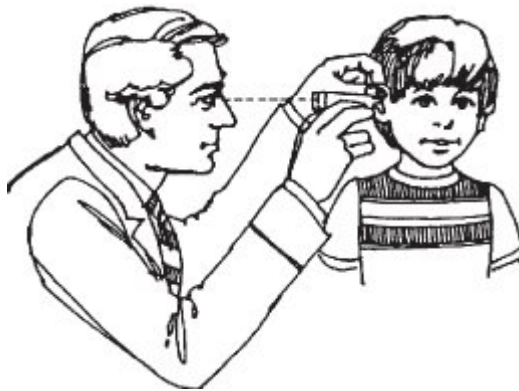
**Figure 12. Positioning the probe**

5. Watch the probe lamp. As soon as a good seal is obtained, the blinking green lamp will change to a steady glow and remain steady while the test is in progress.
6. When the test sequence is over, all lamps on the probe will turn off and the test result can be viewed on the instrument display before printing. It is now appropriate to remove the probe from the ear canal.

**Note** The green lamp blinking again, signifying that another test can be started. The probe lamps will display status of the evaluation:

- **Green lamp:** Blinking - seal has not been obtained to initiate the test sequence.
- **Orange lamp:** The ear canal is not properly sealed and a large pressure leak exists.
- **Yellow lamp:** The probe tip is occluded with cerumen or the tip of the probe against the ear canal wall causing an occlusion.

It is best to remove the probe, examine the tip for cerumen and clean it if necessary. A change of eartip size may also be appropriate. Start the test again.

## Audiometry testing

Prior to testing, ensure that the earphone cords are plugged into the appropriate connectors on the rear panel of the instrument. Both Headphones and Insert phones are available. Select the appropriate transducer and the desired tone type (i.e., pulsed, steady, or FM).



**Caution** Always handle earphones with care. Never drop them or permit them to be squeezed together. Severe mechanical shock may change their operating characteristics and require their replacement. Insert the earphone cords between the earphone cushions during storage to prevent damage from mechanical shock.

## Instructing the patient/subject

Put the patient/subject as much at ease as possible before the test begins. In addition, it is important to try to make them understand how the test is to be conducted and what they will hear. For sake of uniformity, an unvarying explanation is advisable, for example:

*"I am going to place these earphones over your ears. You will hear tones or beeping sounds which may be loud or soft. Whenever you hear, or think you hear one of these tones, raise your hand. Lower your hand when you no longer hear the sound. Remember, raise your hand when you hear the tone and lower your hand when you do not."*

**Note** Modify the instructions accordingly if Insert phones are being used or if indicating the sound is heard using the available handswitch.



**WARNING** Any program aimed at obtaining reliable records of hearing thresholds should be staffed and supervised by appropriately-trained individuals. Training courses leading to certification are available for audiometric technicians in most urban areas.

## Placement of earphones

The most important thing to remember is that a good seal is required between the earphone cushion and the subject's/patient's head and ears. To increase the likelihood of a good seal,

- a. Eliminate all obstruction between the earphones and the ears (e.g., hair, eyeglasses, earrings, hearing aids, etc.).
- b. Adjust the headband so that it rests solidly on the crown of the subject's head and exerts firm pressure on both ears.
- c. Center the earphones carefully over both ears. The earphone with the red connector goes on the right ear. Take care to eliminate any visible gaps between the earphone cushions and portions of the individual's head and the ear on which the cushion rests.

## Placement of Insert earphones

1. Examine the ear canal for obstruction or excessive cerumen.
2. Make sure the sound tube is not blocked.

3. Place the black tubing of an ER-3A foam eartip (optional accessory) completely onto the connector of the sound tube.
4. Roll the foam tip into the smallest diameter possible.
5. Insert the eartip well into the ear canal. Interaural attenuation is improved with deep insertion.
6. Allow foam to expand to acoustically seal ear canal.
7. Discard foam eartips after a single use.

**Note** If using insert phones, ensure the appropriately sized foam tip is selected.

## Response handswitch (optional accessory)

If the optional handswitch is used, make sure that the handswitch connector is properly inserted into the jack on the rear panel. (See “[Optional Accessories](#)” on page 2). The instrument will display an appropriate symbol whenever the handswitch is pressed.

## Tympanometry/Reflex Test Sequence



### Tympanometry only mode

1. Select the **Tympanometry only** mode by pressing **TYMP** on the front panel. The display will immediately show the format for the tympanogram along with the summary information headers ECV,  $\text{cm}^3$ , daPa, and GR. The default scale for compliance is  $1.5 \text{ cm}^3$ . If a compliance peak greater than  $1.5 \text{ cm}^3$  is measured, the instrument automatically scales the compliance axis to  $3.0 \text{ cm}^3$  so that more of the tympanogram data can be seen.
2. Determine the test ear and select the appropriate ear (**R** or **L**) button so that the test results will be labeled properly. It is not possible to change the test ear after the probe is placed in the ear canal.
3. Examine the ear canal to determine the appropriate size eartip for the test and position the eartip on the probe. Be certain that the eartip is pushed as far down the probe tip as possible so that the eartip is flush with the tip of the probe.
4. Note that the green lamp is blinking, which indicates that the instrument is ready to begin the test.
5. Place the probe up against the entrance of the ear canal so that its opening is completely covered with the eartip and there are no visible leaks.
6. The 226 Hz test sequence begins when the instrument determines that a volume between  $0.2 \text{ cm}^3$  and  $5.0 \text{ cm}^3$  is present. This is indicated by the green lamp changing from blinking to steady. From this point on, hold the probe securely in this same position without any movement. Monitor the probe and the individual's ear. At the start of the test, the pressure system establishes a pressure of +200 daPa within the ear canal. When this pressure is achieved, the instrument makes a measurement of ear canal volume. This information is valuable as it indicates whether a good seal has been established and helps to differentiate between two similar Tympanogram types (i.e., a fluid-filled middle-ear system and a perforated tympanic membrane). After the ear canal volume (ECV) is obtained, this compliance value is subtracted from the remaining compliance measurements so that a direct reading of the tympanogram compliance peak is possible.

The pressure sweep begins at the starting pressure of +200 daPa and proceeds in the negative direction at a rate of 600 daPa/second. Measurements of compliance are made continuously as the pressure sweep continues in the negative direction. The slope of the tympanogram increases as the measurement approaches the compliance peak. This signals the instrument to decrease the rate of pressure sweep to 200 daPa/second to ensure a more accurate reading of the compliance peak. After the peak compliance and pressure values are detected and stored, the tympanogram dips downward toward the baseline (i.e., 0 cm<sup>3</sup>) and the pressure sweep rate increases back to 600 daPa/second. The tympanogram sweep ends automatically when the compliance value returns to baseline and the pressure is at least -100 daPa. Only when the middle-ear pressure is very negative is it necessary for the pressure sweep to continue to -400 daPa. The automatic stop when the tympanogram compliance returns to baseline eliminates unnecessary pressurization of the ear and shortens the test time.

When the tympanogram is completed and the test is finished, the steady green lamp turns off and the test results are displayed.

The test results are stored automatically in memory. The actual memory location number is determined by the number of tests that are stored. For example, if this is the first test to be stored in memory, it will be assigned the number M1. If it is the third test to be stored in memory, it will be numbered M3, etc.

In addition to the tympanogram tracing, the screen displays the test summary information. This data includes the ear canal volume (ECV), the compliance peak in cm<sup>3</sup>, the pressure at the peak of the tympanogram in daPa, and the gradient (GR) as a peak width value. This test result can be printed out immediately as a single test by selecting the **Print Screen Only**  button or other tests can be performed and saved before all tests in memory are printed via the **Print All**  button.

**Note** If a second tympanogram needs to be performed, remove and reinsert the probe.

## Tympanometry and Ipsilateral Reflex

The default parameters for this test are tympanometry followed by an ipsilateral acoustic reflex test at 1000 Hz.

When a seal is obtained, the tympanometry sequence is initiated. (See “[Tympanometry only mode](#)” on page 23 for details). As long as no large leak is encountered during tympanometry (orange lamp illuminated) and no occlusion is detected (yellow lamp illuminated), the test automatically transitions to the reflex portion of the test as follows:

1. For 226 Hz probe tones, the pressure from the tympanogram peak compliance is re-established within the ear canal and is offset by -20 daPa so as to avoid any problems with extremely sharp tympanogram slopes (+20 daPa for positive peak pressure).
2. With the air pressure held constant throughout the reflex test sequence, the lowest intensity level for the starting frequency is presented and a measurement of compliance change is made. If the compliance change of at least 0.05 cm<sup>3</sup> for the 226 Hz probe tone is measured, this reflex intensity level is stored in memory, as a response.
3. If no other frequencies were selected for the test, the Tymp Reflex sequence ends here. The green lamp is no longer illuminated indicating that it is appropriate to remove the probe from the ear. The display will indicate the reflex test result as a Yes, as an HL value, or as an HL value plus a tracing of the reflex response curve. The

default setting established in the Program mode determines the manner in which the reflex result is displayed. See “[Program Mode](#)” on page 33.

4. If no response is measured (i.e., for 226 Hz probe tone, a compliance change of at least 0.05 cm<sup>3</sup> was not detected) at the lowest intensity level, the intensity level of the stimulus is automatically increased by 10 dB. If a response is detected, the test sequence for this frequency ends and either the result is displayed on the screen or the test advances to the next frequency selected. However, if no response is measured, the intensity level is increased by 10 dB (e.g., 1000 Hz Ipsi = 105 dB HL) and the stimulus is presented.
5. After the a response is detected, the intensity level is stored as the reflex test result and displayed on the screen. If no response is detected at the highest intensity level, either a No or an NR (depending upon the Program mode setting) is indicated on the screen next to the frequency tested label. If a large pressure leak develops, an NT will appear on the screen next to the reflex test frequency and the test sequence is aborted.
6. The same sequence is followed for each test stimulus selected.

**Note** To change the test default frequencies, see “[RESET TO DEFAULTS](#)” on page 41 of this manual.

The intensity levels available vary with the frequency selected ipsilaterally as follows

### 226 Hz Probe Tone

IPSILATERAL	Intensity Levels
500 Hz	80, 90, 100 dB HL
1000 Hz	85, 95, 105 dB HL
2000 Hz	85, 95, 105 dB HL
4000 Hz	80, 90, 100 dB HL

**Note** Although four frequencies are available during the tympanometry and ipsilateral reflex test mode, most situations require only one or two frequencies to be tested. A selection of the most commonly used frequencies is available; however, it is strongly recommended that only one to two frequencies per test are selected. Holding the probe in the same position for the length of time required to test four frequencies may become uncomfortable for both the tester and individual being tested.

### Temporary programming of ipsilateral acoustic reflex test frequencies

The instrument defaults to a 1000 Hz Ipsilateral test stimulus when the **Tymp Reflex** button is first pressed. Any combination of the four available frequencies (500, 1000, 2000, 4000 Hz) can be selected either temporarily or as revised default parameters. To temporarily modify the default condition -

1. Press the **Tymp Reflex** TYMP REFLEX button.
2. Select the test frequencies by pressing the desired **Frequency** button (e.g., 500 Hz or 1000 Hz). Pressing the Frequency button a second time will deselect that frequency from the test sequence. Test frequencies must be selected before the probe is in the ear. Each frequency selected will be indicated on the display. For example, if 2000 Hz

is selected along with 1000 Hz, the label "I 1000" will appear at the top of the first column of numbers for reflex and "I 2000" will appear directly below it. If 500 is also selected, the screen will be modified so that "I 500" appears at the top of the first column of reflex numbers, "I 1000" will appear directly below "I 500" and "I 2000" will appear at the top of the second column of reflex numbers and directly to the right of "I 500" and so on.

To change the default setting, see "[Program Mode](#)" on page 33 of this manual.

**Note** The second or third intensity level presentations occur only if a response is not detected at the prior intensity level. The test is over when the green lamp on the probe is no longer illuminated.

## Exit tympanometry/reflex

### To exit Tymp Only Mode:

Select **Tymp Reflex** or **Audiometry Mode**. Note that the appropriate screen appears on the display.

### To exit Tymp/Reflex Mode:





Select **Tymp** or **Audiometry Mode**. Note that the appropriate screen appears on the display.

## Audiometry Test Sequence

### To enter the Audiometry mode

1. Press the **AUD** button. Note that the display changes from a Tympanogram or Tymp/Reflex format to an audiogram format.

## Transducer Selection

Select the transducer to be used for the Audiometric testing. Press  to select headphones or  to select insert phones. The LCD will flash a picture of the transducer choice until the transducer button is pressed a second time. With one set of output jacks for the transducers, two buttons allow separate calibration files to be accessed. Be sure that the transducers that are connected to the back of the TM286 are the same as the selected transducer from the front panel. If Headphones are selected, a  will appear in the center of the LCD. If Insert Phones are selected, a  will appear in the center of the LCD.

The settings for the frequencies available during audiometry are defined in the Program mode as 125 through 8000 Hz (normal) or 500 through 6000 Hz (narrow). The factory default setting is the normal frequency range of 125 through 8000 Hz. Upon entering the audiometry mode, the starting frequency is automatically selected to be a steady signal of 1000 Hz at 0 dB HL.

The signal format can be temporarily changed from steady (continuous) to a pulsed or frequency modulated tone. These alternative tone formats remain selected until a different test is selected. The display indicates a **continuous bar** when steady is selected, a **dashed bar** when pulsed is selected, and the letters **FM** when frequency modulation is selected.

The audiometry defaults to testing the right ear first. To start with the left ear, it is necessary to press the **L** button after entering the audiometry mode. Since the

audiometry mode defaults to 1000 Hz at 0 dB HL, the cursor is positioned at the corresponding location on the audiogram.

Please note that even though tabular format may be selected for the audiometric test results on the printout, the LCD display is always in the audiogram format.

### To change the frequency

1. Press the **▶ Hz** button.
2. If the **▶ Hz** button is pressed once momentarily, the frequency increases to the next frequency in the range.
3. If the **▶ Hz** button is held down continuously, it is possible to quickly scroll through the available frequencies. Note that if the button is held down past the 8000 Hz in the normal range (6000 Hz for the narrow range), the frequency scroll wraps around to the lowest frequencies (i.e., 125 Hz with the normal range and 500 Hz with the narrow frequency range). The reverse occurs if the **◀ Hz** button is pressed.

In addition to changing the frequency, the **▶** and **◀** buttons change the position of the cursor on the audiogram. The frequency value of the cursor position on the audiogram is displayed on the right side of the screen.

### To change the intensity level of the test tone

1. Rotate the **dB HL** knob in the clockwise direction to increase the intensity level in 5 dB steps; rotate the knob in the counterclockwise direction to decrease the intensity level in 5 dB steps.

Frequency	Intensity Range
125 Hz	-10 to 50 dB HL
250 Hz	-10 to 70 dB HL
500 to 4000 Hz	-10 to 90 dB HL
6000 Hz	-10 to 85 dB HL
8000 Hz	-10 to 70 dB HL

The cursor on the audiogram moves up and down accordingly. Also, the dB level displayed above the frequency value on the right-hand side of the audiogram changes. For each frequency, there is a fixed intensity range available while rotating the **dB HL** knob as follows:

It is possible to extend the intensity range per frequency 10 dB by pressing the **+10dB** button. The button may only be selected when the intensity level is set to the highest value in the normal range. For example, with the test tone of 1000 Hz, the normal intensity limit is 90 dB HL. When the intensity knob is rotated clockwise to select beyond 90 dB HL, the intensity value above the 1000 Hz to the right of the audiogram flashes indicating the maximum intensity limit has been reached. To go beyond 90 dB HL, select the 10dB button. A large + sign appears on the screen below the 1000 Hz value. The **dB HL** knob can be rotated through two additional positions, 95 and 100 dB HL. Rotating the **dB HL** knob to the next position beyond 100 dB causes the intensity value 100 to flash on the screen to the right of the audiogram; this indicates that the maximum dB HL for the extended range has been reached. If the **dB HL** knob is rotated one more position beyond the flashing 100 dB position, the letters NR appear next to the letters dB above the 1000 Hz. This permits the selection of the no response (NR) symbol on the audiogram during testing. The extended range remains selected until either the intensity level for that



particular frequency (e.g., 1000 Hz) is brought down 5 positions below the maximum dB HL value (e.g., 65 dB HL for 1000 Hz) or the frequency is changed.

To save the threshold for a frequency, press the **M+** button. The appropriate symbol (**O** for right ear and **X** for left ear) for the test ear will replace the cursor. If no response (NR) was measured, an arrow is attached to the **O** or **X** symbol on the audiogram. The last threshold obtained and saved with the **M+** button becomes the value saved in memory and is the value printed on the audiometric test results.

To present the tone to the test ear, press the **Present** bar. A speaker symbol  appears in the center of the screen for as long as the **Present** bar is depressed.

**Note** Although the printout will combine the right and left ear test results on the same audiogram or table, the screen can display only the results from one ear at a time. Therefore, if an ear button (**R** or **L**) is selected while you are still testing a particular ear, the screen will change to a new audiogram. If this happens, it is not possible to return to an incomplete audiogram to complete the test sequence.

## Screening audiometry

1. Carefully position the earphones over the individual's ears so that the **red phone** covers the right ear and the **blue phone** covers the left ear.
2. Ensure that nothing is obstructing the earphones such as earrings, eye glasses or a hearing aid.
3. Instruct the person being tested to raise a hand or a finger (or press the optional **Handswitch**) whenever a tone is heard.
4. Encourage the patient to respond even if he/she thinks a tone is heard.
5. Select the ear to be tested with the **R** (right) or **L** (left) button.
6. Select the desired screening intensity by rotating the **dB HL** knob to the appropriate position. The American Speech Language and Hearing Association recommends 20 dB as the screening level for school-age children. ( See "[Bibliography](#)" on page 67 for further information.)
7. Select the starting frequency by pressing the  and  **Hz** buttons.
8. Present the tone by pressing the **Present** bar.
9. If the individual fails to respond, increase the intensity by 10 dB and try again. Press the **M+** button at the intensity level where the individual responded.
10. Continue the procedure for all the desired frequencies.

## Audiometric Threshold

The TM286 provides two ways to perform Audiometric Threshold testing. The system can be used in a Manual mode or an Automatic Hearing Level mode (**Auto HL mode**). In the Manual mode, the intensity, frequency and presentation of the stimulus are controlled by the tester. In the Auto HL mode, the system presents stimuli based on responses from the Patient Response switch.

## Manual Threshold Audiometry

1. Carefully position the earphones and select the ear to be tested.



2. Familiarize the individual with the test procedure by presenting a tone of 40 dB HL at 1000 Hz.
3. Decrease the intensity in 10 dB steps until the person no longer responds or until you reach 0 dB HL.
4. When you believe the individual understands the procedure (i.e., raise your hand/finger when you hear a tone) proceed with the test.
5. Starting at the desired test frequency, present the tone for a period of one or two seconds.
6. If a response is indicated,
  - a. Decrease the intensity of this same test frequency by 10 dB and present the tone again for one to two seconds.
  - b. If no response is indicated, increase the intensity by 5 dB. Present the tone again.
  - c. If no response is indicated, increase the intensity by another 5 dB.
  - d. If a response is indicated, this is the second time that the individual responded to the same intensity level. Repeat the sequence of down 10 dB and up in 5 dB increments to determine if a correct response is detected at the same intensity level. The threshold is considered to be the minimum level at which a response has occurred two out of three times. Press the **M+** button when this intensity level is indicated on the screen above the test frequency to signify that the threshold level for that frequency has been reached. Note that the appropriate symbol (**O** = right, **X** = left) appears at the correct intensity level where the threshold was determined.
7. Repeat this test sequence for each frequency to be tested.
8. When the thresholds have been obtained for all the desired frequencies, select the other ear and repeat the sequence. Note that the display changes to a new screen for storing the second ear's results. The test protocol follows a down 10 dB and up 5 dB sequence to establish threshold level.

## Automatic Hearing Level

The Automated Hearing Level Procedure (Auto HL) allows the patient to control the evaluation using the response button. The software determines the presentation level of the stimulus based on the Hughson-Westlake Threshold estimation procedure. The patient should be instructed to hold the button down when s/he hears the tone and release the button when the tone goes off. In this procedure, the stimulus level is decreased 10 dB each time the patient presses the button and increased by 5 dB when the button is not pressed. The TM286 will present the stimulus and increase or decrease the intensity of the stimulus based on the patient response. The TM286 response/no response stimuli and determines the hearing threshold based on the data.

## Theory of Operation

The following points describe the stimulus presentation patterns and patient response validity:

1. The stimulus on-time is fixed at 1.5 seconds.
2. The Inter-stimulus interval is randomized between 3 and 5 seconds.

3. When a valid response occurs, the intensity for the next stimulus presentation is decreased 10 dB. When no valid response occurs, the intensity of the next stimulus presentation is increased 5 dB. This is based on the Hughson-Westlake down 10, up 5 dB rule used by most audiologists during threshold testing.
4. The system will determine the response to be valid if the patient response switch is pressed during the stimulus or for 2 seconds following the stimulus off time.
5. The system will determine the patient response to be invalid based on the following occurrences:
  - a. The patient response switch is pressed during the stimulus on time, but not released before the start time for the next intensity presentation.
  - b. The patient response switch is pressed and released only during randomized inter-stimulus interval.
  - c. The patient response switch is pressed and released more than 2 times during the stimulus on and completion of inter-stimulus interval.

Threshold results are displayed as they are saved for each frequency. When the first ear test sequence is completed, the audiometric thresholds for all the frequencies tested are stored in memory. At the start of the second test ear sequence, the results on the LCD will be cleared to display the second ear results. When the second ear sequence is completed, the entire audiogram containing thresholds for both ears are stored in memory. The threshold series for any frequency will be considered invalid if a threshold is not achieved within 18 stimulus presentations, or if the retest result at 1000 Hz doesn't agree within 5 dB of the first result. If the threshold results are considered invalid, the system will exit the Auto HL procedure. The audiogram results obtained thus far will be kept and displayed so that the test can be completed manually.

## Performing the Auto HL Procedure

1. Instruct the patient to press the button on the handswitch when s/he hears the tone and release the button when the tone goes off.
2. Carefully place the headphones or insert earphones.
3. To begin the Auto HL procedure, press the **AUD** button and hold it for 3 seconds. The words **Auto HL** will be displayed at the bottom right corner of the LCD indicating that the Auto HL procedure has been engaged. The first stimulus will be presented when the **AUD** button is released. When a signal is presented, the Speaker symbol  will display on the LCD.
4. When all frequencies have been successfully tested the **Auto HL** will disappear from the LCD indicating the test is finished.

## Exit audiometry

There are two ways to exit the audiometry mode.







- a. Select the **Tymp** mode **TYMP** button
- or -
- b. Select the **Tymp Reflex** **TYMP REFLEX** mode

For details on programming the Auto HL procedure, refer to [“Programming the Auto HL Procedure”](#) on page 36.





## Tests in memory

The Tymp and Tymp Reflex test results are automatically stored in memory when the test sequence ends. Audiometric test results are stored in memory when **M+** is pressed. A total of 12 memory pages are available with the TM286. Each Tymp, Tymp/Reflex or individual ear in audiometry is assigned a page in memory. They are labelled M1 - M12.

## Page mode

To review the individual test results, press the  button and enter "Page mode." The word "Page" will be displayed in the center of the LCD. Testing cannot be performed while the system is in the Page Mode. The memory number is located in the upper right-hand corner of each screen. If, for example, only five tests were stored in memory, only five memory locations can be viewed. The memory can be reviewed one page at a time by pressing the  and  **Hz** button once and observing the result. The entire memory can be scrolled through by holding the  and  **Hz** buttons down continuously. Press the  button to exit "Page Mode" and continue testing.





## Memory erase





If there is a particular test result that must be to delete before printing, enter the Page mode by pressing . Press  or  to display the test result and press **M-**. This erases that particular test result from memory. The LCD displays a blank screen for erased memories with the memory location number located at the top right corner. Upon exiting from the Page mode, the stored memories reshuffle and replace the empty memory with the remaining tests in the order in which they were obtained. The Page mode will be exited when you press the **PRINT ALL**  or **ERASE ALL M--** buttons or any button that would normally begin the setup of a new test. Page Mode is ready only. No changes can be made to audiometric results.

To erase all tests from memory, press the **ERASE ALL M--** button.

## Printing test results

The printout will begin with a header, if it is selected, in the program mode (i.e., TM286 or a custom header). The next two lines contain space for recording the individuals name and the test date. This is followed by the test results in the order they were obtained/selected.

Either a single test can be printed from memory or the entire group of tests in memory can be printed. To print a single test from memory, use the **PAGE**  button to enter the Page mode and the  or  button to arrive at the desired test result to print. When this test is displayed, press the **PRINT SCREEN**  button.



To print all tests in memory, press the **PRINT ALL**  button. When **PRINT ALL**  is pressed and two audiogram tests are stored in memory, they will combine under the following conditions. There must be one left test and one right test sequentially stored in memory. A left and right audiometric pair of tests will not be combined if they are separated in the memory by a Tymp test. Therefore, when tests are erased, the result could cause a change in (left, right) or (right, left) sequence with Audiometric tests. This would result in the wrong audiometric tests being combined when **PRINT ALL**  is selected. Prior to selecting **PRINT ALL** , scroll through the tests in memory to determine where the audiometric tests are located.

To avoid accidental confusion of data, **ERASE ALL M--** before starting a new test patient.



## 4

## Program Mode

To enter the program mode, press the **Program (PROG)** button located on the front panel. There are two screens for the Program mode. To move to the second page, press the Increase Frequency  button or turn the Attenuator knob  until the cursor is next to the arrow on the bottom right column. Press to enter Page 2.

### Basic button functions for moving through the Program menu

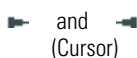

(Cursor)

Moves the cursor sequentially through the list of options on the screen.



(Attenuator Knob)

**M +**

Toggles the option on or off. An asterisk (\*) appears to the left of the item to denote the item has been selected. Pressing **M +** again removes the asterisk, which deselects the item.



(Page)

Use this button to move to the submenu or next page of a menu.

**Save**

The word Save should appear on the lower right corner of the LCD after the **M +** button has been selected.



Indicates there is a submenu. Select  to enter the submenu.

## Program Mode Menu Items

The following screen appears the first time the program mode is entered.

PROGRAM MENU PAGE 1		PROGRAM MENU PAGE 2	
PROBE HZ...	AUD RANGE NORMAL	DATA XFER CONFIG...	INTERNAL PRINTER
TYMP OPTIONS...	AUD RANGE NARROW	POWER UP SETTINGS	EXTERNAL PRINTER
REFLEX DISPLAY...	PRINT - AUDIOGRAM	PRN HEADER WA...	RESET TO DEFAULTS
226 HZ REFLEX...	PRINT - AUD TABLE	PRN HEADER OFF	→
1 kHz REFLEX...	DEF XDUCER DD45	PRN HEADER CUSTOM	
AUTO HL SETUP	DEF XDUCER INSERT	→	
LANGUAGE			

**Note** Pushing the **Print** button while in Program mode will print out the currently programmed settings.

When navigating through the Program menu, features that are not available on the purchased version of the TM286 will be represented by **invalid** on the LCD.

Factory Default settings are listed on [page 41](#).

## Program Menu Page 1 Option Descriptions

### TYMP OPTIONS . . .

This submenu determines tympanogram display and test options.

<b>NORMAL BOX ASHA</b>		<b>BASELINE ON</b> (Not available on the TM286)	<b>1k</b>
<b>NORMAL BOX OFF</b>		<b>BASELINE OFF</b> (Not available on the TM286)	<b>1k</b>
<b>NEWBORN NRM ON</b> (Not available on the TM286)	<b>1k</b>	<b>AUTOSTART ON</b> (Not available on the TM286)	<b>1k</b>
<b>NEWBORN NRM OFF</b> (Not available on the TM286)	<b>1k</b>	<b>AUTOSTART OFF</b> (Not available on the TM286)	<b>1k</b>
<b>50th PERCNT ON</b> (Not available on the TM286)	<b>1k</b>		
<b>50th PERCNT OFF</b> (Not available on the TM286)	<b>1k</b>	→	

### NORMAL BOX ASHA/NORMAL BOX OFF

It is possible to have the Normal Box, as defined by ASHA, appear on the tympanogram screen and printout. The boundaries for this Normal Box are -150 daPa to +100 daPa and 0.2 cm to 1.4 cm<sup>3</sup>.

**Note** A compliance value of 1.5 cm<sup>3</sup> or greater will turn off the ASHA normal box automatically.

**NORMAL BOX ASHA** is the factory default setting. To select the **NORMAL BOX OFF**, move the cursor next to the selection and press the **M-** button to save. **Saved** should appear on the bottom right corner of the LCD and an "\*" should appear next to the **NORMAL BOX OFF** option to denote the selection.

### REFLEX DISPLAY

Reflex test results can be displayed and printed in three different formats:

- Reflex dB HL plus curve

The default setting for this grouping is **Reflex dB HL plus curve**. All reflex test results will appear on the display and printout with the following information:

- I** (Ipsilateral) selected
- Frequency**: 500, 1000, 2000, or 4000 Hz
- Intensity** level where response was detected

d. Tracing of actual response curve

**Figure 13. Display format for TYMP/REFLEX Test  
(Reflex test results with dB HL value and tracing)**

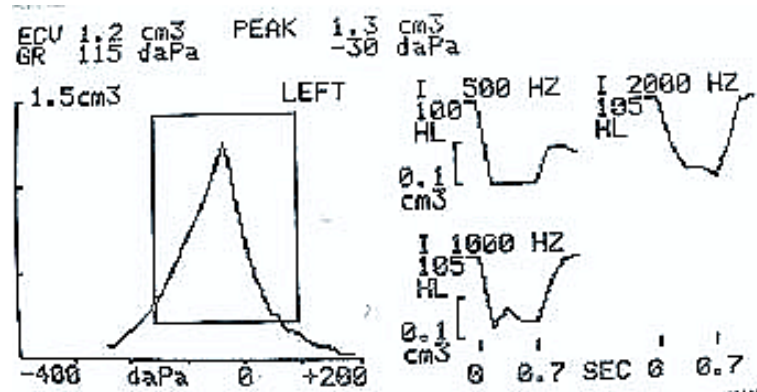

- Reflex dB HL only

If **Reflex dB HL only** is selected, the stimulus frequency, stimulus routing, and the dB HL level for the reflex will appear on the display and printout

**Figure 14. Display format for TYMP/REFLEX Test  
(Reflex test results given in dB HL)**

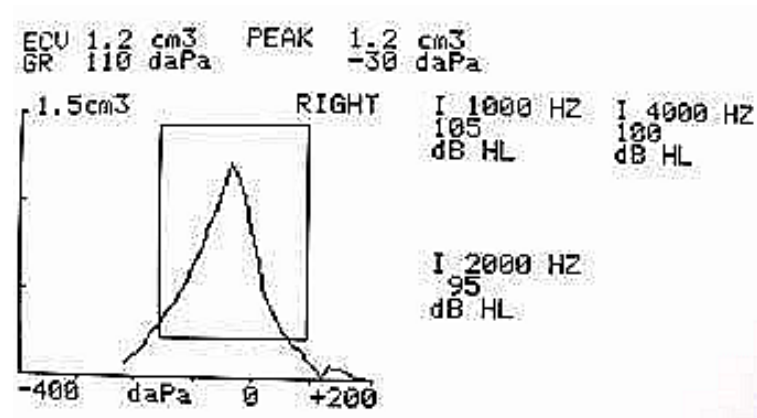

- Reflex yes/no

If **Reflex yes/no** is selected, the dB HL result will be replaced with the word yes (response detected at one of three levels) or no (no response detected).

**Figure 15. Display format for TYMP/REFLEX Test  
(Reflex test results given as Yes or No)**

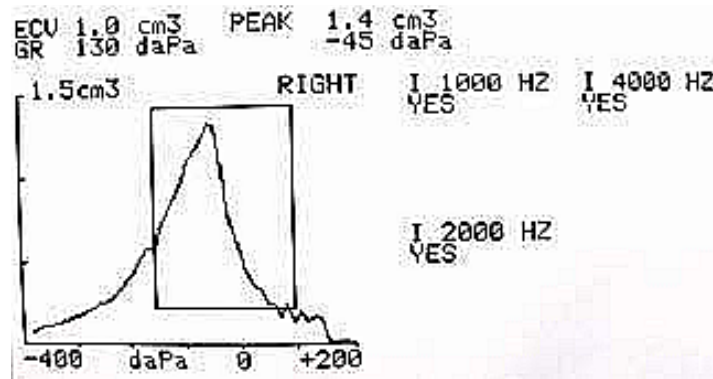

When the reflex test cannot be performed, due to a leak or early extraction of the probe, a "NT" will appear next to the frequency.

**To select a different setting for reflex format:**

1. While in the Program mode, move the cursor to the desired setting.
2. While the square cursor is positioned in front of the desired setting, press the button.

The word **SAVED** appears in the lower right corner of the screen. The previous setting is deselected. An asterisk (\*) is displayed beside the new default setting.

## REFLEX

Ipsi	500
Ipsi	1000
Ipsi	2000
Ipsi	4000

This feature determines the stimuli and signal routing of the acoustic reflexes as default settings. To select the frequencies, move the cursor next to the selection and press the **M+** button to save. **Saved** will appear on the bottom right corner of the LCD. An \* will appear next to the selected stimulus routing and frequency. The system will allow 4 stimulus choices of any combination (i.e., ipsi or contra) for display and printing.

## AUTO HL SETUP

### Programming the Auto HL Procedure



Navigate the cursor to the **Auto HL Setup** line located on the **Program Mode Screen 1** and press the  button. The following submenu will appear:

**Test Frequencies (Hz) ...** →  
**Intensity Range (dB HL) ...**  
**Start test ear ...**





**Scoring rule . . .****Tone Format . . .**

Place the cursor next to the line item, press the  button to enter the submenu item. Auto HL features are selected in the Program mode by placing the cursor next to the parameter and pressing the **M+** button to engage the selection.

To exit this submenu, move the cursor to  and press .

**Test Frequencies (Hz):** This submenu determines the frequencies to be tested during the Auto HL procedure. Move the cursor to the frequency and press the **M+** button to select or deselect the frequencies for presentation during the Auto HL procedure. An asterisk next to the frequency denotes that it has been selected for presentation. The submenu will appear as follows with the factory default settings:

<b>Test frequencies (Hz)</b>	
<b>125</b>	<b>*2000</b>
<b>250</b>	<b>*3000</b>
<b>*500</b>	<b>*4000</b>
<b>750</b>	<b>*6000</b>
<b>1000</b>	<b>8000</b>
<b>1500</b>	<b>Return to Auto HL Set</b>

**Intensity Range (dB HL):** This submenu defines the minimum and maximum decibel level (HL) that will be presented during testing. To change the Min. dB (lowest level), place the cursor on that line and turn the **HL knob** on the front panel to the desired level. Press the  to move the cursor to the Max dB line and use the HL knob again to change the maximum level. Press the  button to move the cursor to the **Return to Auto HL Setup** and press  to exit the submenu. Asterisks on this menu denote factory default settings.

**Intensity Range (dB HL)**  
**Min. dB: 0\* Return to Auto HL Set up**  
**Max dB: 90\***

**Note** Setting the **Min. dB range to 20** and the **Max dB range to 45** allows a quick screening procedure using the Auto HL feature.

**Start Test Ear:** This submenu allows you to select the ear that will be tested first during the Auto HL procedure. To change the start ear, move the cursor next to either the R (right ear) or L (left ear) and press the button. An asterisk will appear next to the selected start test ear.

**Start Test Ear**

**\*R** **Return to Auto HL Set up**  
**L**

**Scoring Rule:** This submenu defines the number of valid responses required to determine threshold. To change the **Scoring Rule**, move the cursor next to the desired Scoring Rule and press the **M+** button. An asterisk denotes the selected Scoring Rule.

#### Scoring Rule

\*2 out of 3                      Return to Auto HL Set up  
3 out of 5

**Tone Format:** This submenu defines the stimulus type to be used during the Auto HL procedure. Steady, Pulsed and FM tones are described in the specification section of this manual. To change the Tone Format, move the cursor next to the desired Tone Format and press the button. An asterisk denotes the selected Tone Format.

#### Tone Format

\*Steady                      Return to Auto HL Set up  
Pulsed  
FM

To exit this submenu, move the cursor to  $\rightarrow$  and press .

## AUD RANGE NORMAL/AUD RANGE NARROW

All eleven frequencies are available during audiometry or the range can be abbreviated to eight frequencies. The default setting is **Aud Range Normal**. To select the abbreviated frequency range: Position the square cursor in front of the feature **Aud Range Narrow**. Press the **M+** button to save this narrow range for audiometric testing. The word **SAVED** will appear in the lower right-hand corner and the asterisk now appears in front of the narrow range selection. The normal range of frequencies includes 125 Hz through 8000 Hz. The narrow range of frequencies includes 500 Hz through 6000 Hz. In the **AUD** mode, if the narrow range is selected, the  $\rightarrow$  and  $\leftarrow$  **Hz** buttons will allow you to scroll through this abbreviated frequency range only. Both the screen and printout will still be labeled with the full range of frequencies (i.e., 125 Hz through 8000 Hz).

## PRINT - AUDIOGRAM / PRINT - AUD TABLE

The audiometric test results can be printed out in an audiogram format (**PRINT - AUDIOGRAM**) or in a tabular format (**PRINT - AUD TABLE**). The default setting for this function is the print audiogram format.

**Note** When a specific frequency is not tested, the result will be a break in the audiogram on the printout. This eliminates the assumption that a threshold exists at that untested frequency.

To change the print option, move the cursor in front of the description **PRINT - AUD TABLE**.

Press the **M+** icon to save this format as the new default parameter. The word **SAVED** appears in the lower right-hand corner of the display to indicate that this new setting has been saved.

With the **PRINT - AUD TABLE** selected, all audiometric test results will appear in a table with the frequency range typed horizontally along the top of the table followed by two

lines of test data. The test results for the right ear will appear next to the letter R and below each frequency tested. The test results from the left ear will follow below the right ear results.

**Note** The **PRINT - AUD TABLE** setting selects the format for the printout only. An audiogram always appears on the LCD while in AUD Mode.

## DEF XDUCER EXTERNAL HEADSET EARPHONES / DEF XDUCER INSERT

The **External Headset Earphones** are the factory default transducers. To select the **INSERT EARPHONES** as the default start up option, move the cursor next to the **DEF XDUCER**.

**INSERT** selection and press **M+** to save. **SAVED** will appear on the bottom right corner of the LCD. An "\*" will appear next to the **DEF XDUCER INSERT** option to denote the selection.

# Program Menu Page 2 Option Descriptions

## DATA XFER CONFIG

<b>* 115.2 KBAUD</b>	<b>* NO PARITY + 8-BIT</b>
<b>57.6 KBAUD</b>	<b>ODD PARITY + 7-BIT</b>
<b>38.4 KBAUD</b>	<b>EVN PARITY + 7-BIT</b>
<b>17.2</b>	<b>SPC PARITY + 7-BIT</b>
<b>9600 BAUD</b>	<b>* XON/XOFF DISABLED</b>
<b>4800 BAUD</b>	<b>XON/XOFF ENABLED</b>

These settings are used to allow the data transfer from the TM286 to a computer. The settings must be the same on the TM286 and the computer. The factory defaults are defined by an \*.

## POWER UP SETTINGS



**TYMP**  
**\* TYMP REFLEX**  
**AUDIO**

The feature determines the mode displayed upon start up. An asterisk will denote which option is selected to appear on the LCD when the system is first powered up. The factory default setting is TYMP REFLEX.

## PRN HEADER WA/PRN HEADER OFF/PRN HEADER CUSTOM

There are three options for the print header on the printout.

### PRINT HEADER WA

This is the factory default setting for this feature. Each time the **Print Screen**  or **Print All**  tests in memory buttons are pressed, the printout will begin with the label **TM286**.

### PRINT HEADER OFF

If this option is selected, no header will be printed before any test results, which will save space and printout time.

### PRINT HEADER CUSTOM

Select this option to design a custom header, which might be the name of an individual facility, department or company. To type in the custom header, position the square cursor in front of **PRN HEADER CUSTOM**. Press **M+** to select it as the new default setting. The word **SAVED** appears in the lower right corner.

If **PRN HEADER CUSTOM** is selected, a line cursor will flash in the left-hand corner below the words **PRN HEADER CUSTOM**. To “type” in the desired header, use the **dB HL knob**. Rotating the knob clockwise will sequence you through the alphabet in the forward direction and rotating this knob counterclockwise will sequence you through the characters in a reverse direction. The available character set is: A -Z; 0 - 9; and a blank space. A total of 35 character spaces are available. When the desired character is displayed, press the **M +** button to store it. The cursor will move into position for the next character. Select the next character and press to store. When the custom header is complete, press the **PROG** button to exit from the submenu. To change/delete a previously saved character, press the **←** to position the cursor at that character. Use the HL knob to select the new character to change or select the blank space to delete.

**Note** To center the header, consider the length of the name to be inserted and calculate from the left margin where the header will begin. Type blank spaces to the start point of the custom header.

### INTERNAL PRINTER/EXTERNAL PRINTER

These items toggle between either printing to the internal printer (4" paper) or sending the information to an external printer. The external printer is connected through a USB port on the back panel. The printer must be a DeskJet with PCL3 or PCL3GUI protocol.

To select the printer, move the cursor next to the Internal or External printer and press the **M +** button to save the setting.

### RESET TO DEFAULTS

This option will reset the programmable settings to the Welch Allyn factory defaults.

<b>Program Mode - Factory Default Settings</b>	
<b>AUDIOMETRY RESULTS</b>	- <b>PRINT - AUDIOGRAM</b>
<b>REFLEX RESULTS</b>	- <b>REFLEX HL + CURVE</b>
<b>226 Hz Reflex</b>	- <b>Ipsi 1000 Hz</b>
<b>NORMAL BOX</b>	- <b>NORMAL BOX ASHA</b>
<b>AUDIOMETRY RANGE</b>	- <b>AUD RANGE NORMAL</b>
<b>DEFAULT TRANSDUCER</b>	- <b>DD45</b>
<b>PRINT HEADER</b>	- <b>PRN HEADER WA</b>
<b>LANGUAGE</b>	- <b>ENGLISH</b>
<b>DATA XFER CONFIG</b>	- <b>115.2 KBAUD</b>
	<b>NO PARITY + 8-BIT</b>
	<b>XON/XOFF DISABLED</b>
<b>POWER UP SETTING</b>	- <b>TYMP REFLEX</b>
<b>PRINTER TYPE</b>	- <b>INTERNAL PRINTER</b>
<b>AUTO HL SETUP</b>	
<b>TEST FREQ (Hz)</b>	- <b>500 Hz</b>
	- <b>1000 Hz</b>
	- <b>2000 Hz</b>
	- <b>3000 Hz</b>

	- 4000 Hz
	- 6000 Hz
<b>INTEN RANGE (DBHL)</b>	
<b>MIN DB</b>	- 0
<b>MAX DB</b>	- 90
<b>START TEST EAR</b>	- RIGHT
<b>SCORING RULE</b>	- 2 OUT OF 3
<b>TONE FORMAT</b>	-STEADY

### Exiting the program mode

Press the **PROG** button to exit the program mode and return to the previously selected test mode.

## 5

## Routine Maintenance

### PreTest Tympanic checks

A test cavity is provided with this instrument. This test cavity enables the ability to quickly verify, on a daily basis, the proper calibration of the unit. Welch Allyn strongly recommends that this quick check is a part of the daily routine.

**Figure 16. Test cavity**

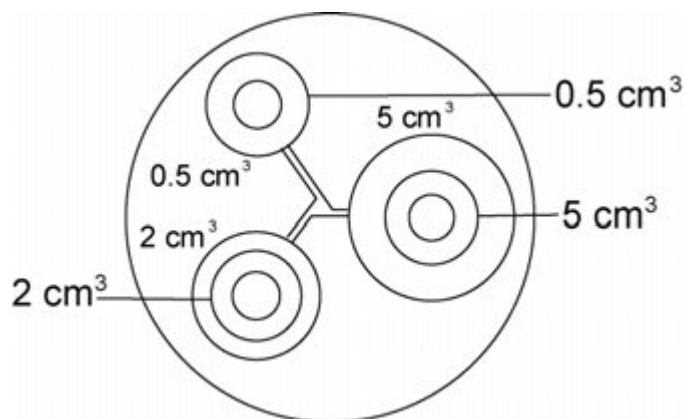

#### Calibration Quick Check for Tympanic/Reflex

To initiate the quick check, select the **Tymp only** mode and insert the probe into the 0.5 cm<sup>3</sup> opening on the test cavity. See ["Test cavity"](#).

The instrument is designed to start automatically, it is important that the probe is inserted as quickly and as smoothly as possible. During the calibration check, the probe must be held carefully and without movement. Do not place the probe on the same counter as the instrument or any moving object during this check as mechanical noise may be picked up by the probe and interfere with the calibration check.

The calibration check will start automatically if the probe has been inserted into the cavity properly. This is confirmed by the **green** lamp changing from blinking to a steady condition. If the **orange** lamp is illuminated, the probe is not properly positioned within the cavity so that a large pressure leak exists. If the **yellow** lamp is illuminated, the probe tip has been occluded. In either case, remove the probe and wait for the blinking green lamp. Insert the probe once again. If necessary, clean the probe tip as described later in this chapter.

The green lamp will resume blinking when the probe is removed from the test cavity. The tympanogram on the display represents the response from the 0.5 cm<sup>3</sup> hard walled cavity. The ECV (ear canal volume) should read 0.5. The letters NP will appear alongside the pressure (daPa) and compliance (cm). Three dashed lines - - - will appear alongside the

gradient (GR) Using the same sequence, place the probe in the test cavity opening labelled 2.0 cm<sup>3</sup>. The resulting tympanogram should be identical other than the ECV should read 2.0 cm<sup>3</sup>. The same sequence can be followed with the 5.0cm<sup>3</sup> opening on the test cavity. To keep a record of this test cavity calibration check, simply press  the button on the front panel of the instrument.

Since sound pressure will vary with altitude and barometric pressure, some variation from the 0.5, 2.0 and 5.0 cm<sup>3</sup> readings may be observed. The instrument is carefully calibrated at our factory, which is at approximately 850 feet above sea level. An elevation of 1000 feet or higher, the instrument may need to be recalibrated to account for elevation (See "Altitude adjustment" below for more details). It is not necessary to recalibrate for barometric pressure changes on a daily basis. Keep in mind that a change in barometric pressure (i.e., from low to high or vice-versa) will slightly affect the test cavity readings. To keep a record of this test cavity calibration check, press the Print All  button on the front panel of the instrument.

## Altitude adjustment

The altitude calibration adjustment enables a "correction" to the ear canal volume (ECV) measurement and test cavity volume measurement for variations due to altitude. The instrument is a pressure sensitive device that makes measurements relative to ambient air pressure. Changes in air pressure due to weather or altitude will affect the ECV readout of the instrument. The slight pressure change resulting from changing weather conditions will usually yield volume readouts with  $\pm 0.1$  cm<sup>3</sup> of the expected cavity value, but pressure changes due to altitude can shift these cavity values by as much as 30%. These changes in pressure do not affect the accuracy of the compliance measurement system in any way. However, it will affect the ECV values. The altitude calibration mode allows adjustment of the Auto Tym without the services of a qualified Welch Allyn representative.



**Table 1. 226 Hz Altitude Correction**

**226 Hz Probe**

<b>Altitude in Feet</b>	<b>Equivalent 2.0 cc Reading</b>
<b>0</b>	<b>2.0 <math>\pm</math>0.1</b>
<b>1000</b>	<b>2.1 <math>\pm</math>0.1</b>
<b>2000</b>	<b>2.2 <math>\pm</math>0.1</b>
<b>3000</b>	<b>2.2 <math>\pm</math>0.1</b>
<b>4000</b>	<b>2.3 <math>\pm</math>0.1</b>
<b>5000</b>	<b>2.4 <math>\pm</math>0.1</b>
<b>6000</b>	<b>2.5 <math>\pm</math>0.1</b>
<b>7000</b>	<b>2.6 <math>\pm</math>0.1</b>
<b>8000</b>	<b>2.7 <math>\pm</math>0.1</b>
<b>9000</b>	<b>2.8 <math>\pm</math>0.1</b>
<b>10000</b>	<b>2.9 <math>\pm</math>0.1</b>

**Note** Operation of the system at an altitude of 10,000 feet may affect the ability to pressurize to the maximum 5.00 cm<sup>3</sup>.



To enter altitude calibration, press ,  and  simultaneously. The LCD will now display the Settings Main Menu. When entering the Settings Main Menu, the display will read as follows:

**Altitude - user check**

**Cal modes**

**Page modes**

**- Back to normal -**

The cursor will be next to **Altitude - user** check. Press  to enter **Altitude - user** check.





1. When entering the altitude mode, the display will read as follows:

**Altitude Mode**

**ECV 2.0**

**cm<sup>3</sup>9.99**

**Standard**

2. Select **226 Hz** probe tone.
3. Place the probe into the 2.0 cm<sup>3</sup> cavity provided with the instrument and check the cm<sup>3</sup> value against the altitude correction table for accuracy.
4. If the measured volume is not within the published table value  $\pm 0.1$  cm<sup>3</sup>, then exit the altitude mode by pressing the **PROGRAM MODE** button and contact field service. Providing the measured volume agrees with the published table  $\pm 0.1$  cm<sup>3</sup>, proceed with the altitude adjustment.
5. With the probe still in the 2.0 cm<sup>3</sup> cavity, press the **PROG** button to enter the custom calibration mode. **CUSTOM** will appear on the fourth line of the display.
6. The value now displayed in the cm<sup>3</sup> display area is the volume measured and adjusted to the current altitude. If the value displayed is 2.0cm<sup>3</sup>, the volume is adjusted to the current site.
7. If the value is not 2.0 cm<sup>3</sup>, press the **M + SAVE** button to adjust the volume measurement to the current altitude.  
The measured volume should now read 2.0 cm<sup>3</sup>.
8. To exit the altitude mode, press the **PAGE**  button to return to the Settings main menu.
9. Move the cursor using  and  to **Back to Normal** and press the **PAGE**  button to return to the Normal mode.

**Note** CAL MODES and DIAG MODES can only be accessed by Welch Allyn trained individuals. If these items are selected, "Invalid Selection" will flash on the bottom right to indicate they are currently disabled.



**WARNING** Welch Allyn recommends only trained personnel enter the Calibration and Diagnostic submenus listed below the Altitude Adjustment in Calibration mode.

## Pre-Test Audiometric Checks

### Noise recovery period

Exposure to high levels of sound (e.g., unmuffled lawn mowers, loud music, gunfire) tends to create a temporary threshold shift (TTS) which diminishes with time after exposure. Any subject/patient tested soon after such exposure may exhibit a hearing loss that does not reflect his or her normal hearing threshold. It is, therefore, important that the testing procedure prescribe some time interval - usually at least 16 hours- between the last exposure to high-level sounds and the administration of any hearing test.

### Elimination of ambient noise

Excessive noise in the test environment during audiometric testing such as that produced by conversation, typewriters, public address systems reduces test validity as it tends to mask the test signals, particularly at the lower frequencies where earphone cushions provide less effective attenuation. An acoustically treated room may be required if ambient noise reaches objectionable levels (i.e., sufficient to cause apparent hearing loss at the low frequencies). Also, Audiocups are available from Welch Allyn as an optional accessory. If the person being tested is in the same room as the audiometer, it is recommended that he/she be seated about three feet (1 meter) away from the instrument.

Maximum permissible noise levels are specified by the American National Standards - Criteria for Permissible Background Noise during Audiometric Testing, ears covered with earphones (S3.1 1991 revised). The table below, "[Maximum Permissible Background Noise Levels](#)" shows the maximum background levels that can be present inside the room while a valid hearing test is being conducted. For more comprehensive information about hearing testing and hearing conservation see the "[Bibliography](#)" on page 67.

**Table 2. Maximum Permissible Background Noise Levels**

Frequency (Hz)	Test Room Maximum dB SPL in 1/3 Octave Band
125	29.0
250	17.5
500	14.5
750	16.5
1000	21.5
1500	21.5
2000	23.0
3000	28.5
4000	29.5
6000	33.0
8000	38.5

## Biological Check

For Tympanometry and Reflex tests, the best way to determine that the instrument is operating properly is to perform a daily check on a normal ear - the operator's ear if possible. This allows the operator to listen for the probe tone and the stimulus tone

(during reflex) and to determine if the air pressure system is working properly. Keep a copy of the tests for a day-to-day reference in checking the instrument.

To perform a biological check in Audiometry, select the Audiometry (**AUD**) mode button. The display changes from the tympanogram format to an Audiogram format. Select **Headphone** or **Insert Phone**. (When changing transducers, the icon for the new transducer will flash on the LCD until the button is pushed again. The **← Hz** and **→ Hz** buttons determine each frequency and the **dB HL** knob alters the intensity of each frequency. Position the test headset so that each earphone is covering the appropriate ear (i.e., **red** is right and **blue** is left). Select the right earphone by pressing the front panel button labelled **R** and check for the following while depressing the **Present bar**:

- a. Pressing the **← Hz** button changes to a lower frequency.  
Pressing the **→ Hz** button changes to a higher frequency.
- b. Each frequency or tone is pure (i.e., there is no distortion or crackling sound present).
- c. Rotating the **dB HL** knob in a clockwise direction increases the intensity (louder). Rotating the **dB HL** knob in a counterclockwise direction decreases the intensity (quieter).

Since individual thresholds can shift up or down as much as 5 dB from one day to the next, variation within this range may be considered acceptable. Variations that exceed this range, however, are likely to reveal problems that require attention. The routine maintenance checks described in this chapter, may suggest the source and solution to the problem. If they do not, the instrument should receive technical service by a Welch Allyn certified technician before further use.

### Preventive Maintenance

Preventive maintenance does not require access to the interior of the instrument and may be performed by the operator.

For the TM286, preventive maintenance consists of periodically cleaning and inspecting the exterior of the instrument. We also recommend cleaning and inspecting the accessories such as the probe and/or earphones. It is recommended a routine schedule is implemented for these purposes.

### Cleaning the system

Turn **OFF** the system power before cleaning the instrument. Do not permit solutions or sterilization agents to seep into the electronic portions of the system. Take special care around controls, connectors and panel edges. Do not use any abrasive cleaners.

Remove any dust from the exterior of the system with a soft brush or cloth. Use a brush to dislodge any dirt on or around the connectors and panel edges. Remove stubborn dirt with a soft cloth slightly dampened with a mild detergent solution or cold sterilization agent.

### Recommended cleaning solutions

Housing components should be wiped with a damp cloth containing soap and water, isopropyl alcohol, ammonia based cleaners or bleach based cleaners.

### Cleaning patient contact reusable devices

To help ensure patient safety, prevent cross infection and provide effective service, Welch Allyn patient contact devices must be properly maintained. Maintenance should include cleaning before each use.

The earphone cushions and patient hand switch can be wiped with a slightly damp cloth containing soap and water, isopropyl alcohol, ammonia based cleaners or bleach based cleaners. Gently wipe the earphone cushions with the slightly damp cloth taking care not to get moisture in the speaker portion of the earphones.

We recommend eartips be discarded after use. We do not recommend cleaning and re-using the rubber probe eartips for tympanometry or the foam eartips used with the insert earphones.



**WARNING** It is recommended that all repairs be performed by a qualified Welch Allyn service representative only. Malfunctions resulting from improper maintenance or repair by anyone other than an authorized Welch Allyn representative will be the responsibility of the user.

### Probe care - Tymp/Reflex Probe

With normal use, cerumen can work its way inside the probe nose cone (probe tip). During the warm-up period each day and throughout the day, inspect the probe tip to make sure it is clean and free of cerumen. Refer to the following instructions for cleaning and maintaining the instrument's probe.

#### Probe nose cone cleaning

Remove the nose cone portion of the probe:

1. Hold the body of the probe in one hand (e.g., left) near the tip and grasp the nose cone of the probe in the other hand (e.g., right).
2. Rotate the nose cone portion of the probe counterclockwise until the nose cone is completely separated from the probe (See ["Probe nose cone removal"](#) below).
3. Place the probe body securely on a table and inspect the nose cone for cerumen. Use floss cleaning thread to remove any cerumen by inserting the floss cleaning thread through the back portion of the nose cone and pulling it through the front opening. It may be necessary to repeat this several times to remove all the cerumen.

#### Figure 17. Probe nose cone removal

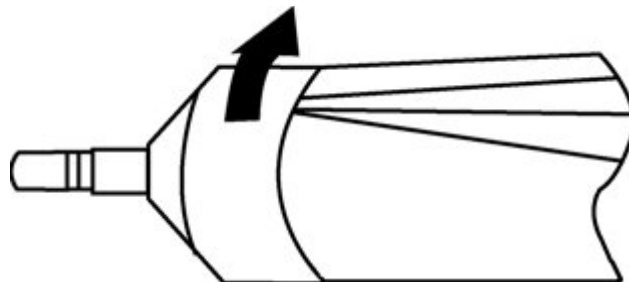

**Note** The probe nose cone can be sterilized via conventional methods including autoclaving.

## The O-Ring

There is an O-Ring seated at the end of the threads on the probe. As a preventative maintenance measure, and to ensure that the nose cone of the probe unscrews easily, do not clean or remove the lubricant from the O-Ring. If the O-Ring appears to be void of any lubricant, or if the nose cone itself was difficult to remove, apply a high-quality synthetic lubricant such as those considered "food-grade." Refer to "[O-Ring care](#)" and apply as described in the instructions that follow.

**Figure 18. O-Ring care**

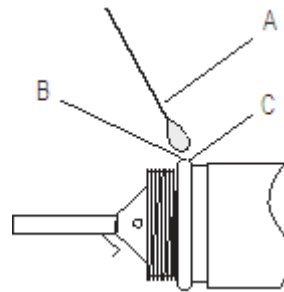

**A: Cotton swab**

**B: Lubricant**

**C: O-Ring (enlarged for detail)**

1. Place a small drop of lubricant at the front outer surface of the O-Ring.
2. Using a finger or a cotton swab, spread a thin layer of lubricant completely around the front and outer surface of the O-Ring. Ensure that no lubricant spreads into the threaded area of the nose cone. Only a thin layer of lubricant is necessary. Excessive application or build-up may affect test results.

## The probe wire

Inside the probe body, there is a metal tube that contains a wire required for cleaning purposes.

1. Carefully remove this wire from the metal tube (See "[Probe wire removal](#)" below). This will pull any cerumen out of the metal tube.

**Figure 19. Probe wire removal**

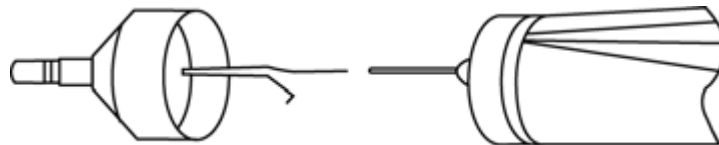

2. Examine the wire for cerumen.
3. If necessary, clean the wire with a lint-free tissue.
4. Reinsert the wire into the metal tube and push it in as far as it can go.

**Note** The wire must be inserted into the metal tube for the instrument to function properly.

### Probe reassembly

After cleaning, reassemble the probe nose cone to the probe body by screwing the cone back onto the probe. Take care to align the threads on both the probe body and the nose cone before screwing the pieces together. Only screw the nose cone on until it is finger tight. It may be helpful to gently squeeze the two sides of the probe case together while screwing the nose cone into place.

**Note** The probe nose cone must be screwed firmly in place to guard against any air leaks.

### Earphone Care

With proper care, the earphone and cords provided with the instrument should last a long time. Moisture should not be allowed anywhere near the earphone itself as this will damage the diaphragm and grill cloth, requiring its replacement. The earphone cushions can be wiped with a slightly damp cloth, taking care not to get moisture in the speaker portion of the earphones.

With extended use, earphone cords tend to fray internally at the connectors (i.e., between the cord and the instrument's connector, and between the cord and the earphone connector). This fraying may cause a decrease in the signal level or cause the signal to be intermittent. To check for this:

1. Position the test headset properly and select a frequency (e.g., 1000 Hz) at 35 dB HL.
2. Select the right earphone and press the **Present bar**.
3. While the Present bar is depressed, flex the earphone cord next to the connector at both ends.
4. Listen for an intermittent signal, an abrupt change in signal intensity level or a scratchy sound superimposed over the selected frequency that coincides with the flexing of the cord. The presence of any of these conditions indicates that the cord should be replaced.
5. Also, examine the earphone cord for cuts or tears in the covering shield and the earphone cushion for signs of damage. If either problem is noticed, the earphone cord or cushion should be replaced. Both parts are easily replaced without the need for recalibration. However, if the earphone receives shock damage or is replaced for any reason, the instrument will need to be recalibrated.
6. Repeat this same sequence with the left earphone.

### Paper supply

To streamline each testing session, it is a good idea to check the amount of paper left inside the printer compartment. Extra rolls of paper should be kept nearby.

**Note** The number of tests per roll of paper will vary with the version Auto Tympanometer being used and the type of tests being performed. (See [page 64](#) of this guide for approximations). Replacement paper can be purchased from Welch Allyn at Tel.: 1-800-535-6663 (In U.S.A. only) or Tel.: 1-800-561-8797 (in Canada only).

# 6

## Test Results

---

### Ear Canal Volume - Tympanometry

#### Normal

As a general rule, values for ear canal volume should be between 0.2 and 2.0 cm<sup>3</sup>. However, the normal values will vary with age and bone structure.

#### Abnormal

An ear canal value of less than 0.2 cm<sup>3</sup> indicates an abnormal condition. If the probe is partially plugged with cerumen or if the probe is positioned against the ear canal wall, a smaller than expected value will be measured. Also, if an individual has a relatively large bone structure for his/her age group and a smaller than expected value is measured, the probe could also be partially occluded or against the canal wall. It is also possible to collapse the canal if the probe is held too firmly against it. Examine the Tympanogram and the reflex results to confirm results. If they are abnormal as well, it is good practice to repeat the test.

An ear canal volume greater than 2.0 cm<sup>3</sup> also may indicate an abnormal condition. An important application of the ear canal volume measurement is to determine if there is a perforation of the tympanic membrane. If there is a perforation due to trauma or due to the presence of a pressure-equalization (P-E) tube, the measured ear canal volume will be much larger than normal since the combined volume of the ear canal and the middle-ear space is being measured. The maximum ECV is 5.0 cm<sup>3</sup>, any space larger than that will be recorded as 5.0 cm<sup>3</sup> or may not seal.

### Compliance Peak

#### Normal

The range of normals for compliance is 0.2 cm<sup>3</sup> to approximately 1.4 cm<sup>3</sup>. Some protocols use a larger range up to 1.8 cm<sup>3</sup>. A measured compliance peak within this range indicates normal mobility within the middle-ear system.

#### Abnormal

A compliance value of less than 0.2 cm<sup>3</sup> indicates a pathological condition as the middle-ear system is stiffer than normal. To distinguish the probable cause of the stiffening, the pressure value where this stiffened compliance peak occurs needs to be considered. For example, normal pressure along with a stiff middle ear system is indicative of otosclerosis, a severely scarred tympanic membrane or a layer of plaque across the tympanic membrane. On the other hand, abnormal pressure along with a stiffened

middle-ear system is consistent with a poorly functioning eustachian tube with possible effusion (serous otitis media) or "glue ear."

**Note** If the measured compliance value is less than  $0.1 \text{ cm}^3$ , the letters NP will be printed next to the heading  $\text{cm}^3$  on the screen and printout. The letters NP indicate a poorly defined or flat Tympanogram. The Tympanogram may depict a very shallow peak.

A compliance value greater than  $1.4 \text{ cm}^3$  (or  $1.8 \text{ cm}^3$ ) indicates a hyperflaccid tympanic membrane or a possible disarticulation depending upon how far above the normal range the value is. Generally speaking, a compliance value of greater than  $3.0 \text{ cm}^3$  is indicative of a disarticulated ossicular chain. Further testing is necessary to confirm this suspicion.

**Note** If a compliance value is measured to be greater than  $1.5 \text{ cm}^3$ , the instrument automatically changes the range assigned to the graph to  $3.0 \text{ cm}^3$ .

The validity of tympanometry and acoustic reflex testing is dependent upon a healthy tympanic membrane. A pathological condition at this membrane can mask the true condition of the middle ear.

## Pressure Peak

### Normal

Strict rules for middle-ear pressure indicate a normal range of  $\pm 50 \text{ daPa}$ . However, for most applications, a normal range of  $-150 \text{ daPa}$  to  $+100 \text{ daPa}$  is used.

### Abnormal

Very rarely, an extreme positive pressure condition will be observed. Some researchers have reported high positive pressures at the onset of acute otitis media.

Pressure values more negative than  $-150 \text{ daPa}$  are indicative of a poorly functioning Eustachian tube. The severity of this condition is determined by how negative the pressure is and its impact on the compliance peak.

If no pressure peak is measured over the pressure range of  $+200 \text{ daPa}$  to  $-400 \text{ daPa}$ , then the letters NP will appear on the screen and the printout. This indicates that no pressure peak was detected over this pressure range.

## Gradient

### Normal

When testing a child, the normal range for the gradient is between  $60$  and  $150 \text{ daPa}$ . (Infants may show higher gradient values due to the mobility of their ear canals). The range of normal is somewhat narrower for adults (i.e.,  $50$  to  $110 \text{ daPa}$ ).

### Abnormal

A high gradient value (greater than the high end of the normal range per age group) is indicative of middle-ear effusion. The reduced compliance values and negative middle-ear pressure characteristic of developing or resolving otitis media with effusion (OME) will be manifested in a broad tympanogram with a large gradient value. However, abnormal



gradient values may also be found in the absence of abnormal parameters. This could indicate a transient OME, so a retest after several weeks may be recommended.

When the middle ear's mobility is reduced to near 0 cm<sup>3</sup>, due to viscous effusion or a "glue-ear" condition, no gradient value can be measured. In this case, dashes (- -) will be displayed next to the letters GR.

Very low gradient values are associated with a flaccid middle ear system. These low values should be taken into consideration with the ear canal volume and compliance peak values to determine the probable use of the flaccid condition.

## Acoustic reflex

### Normal

For screening purposes, an ipsilateral reflex measured at any one of the levels available per frequency can be considered normal. Obviously, the lowest values are desired. However, without knowing the hearing threshold level of the individual per frequency, it is difficult to make a more definite statement. Generally speaking, the reflex is reported to occur at between 70 and 90 dB HL above the hearing threshold in patients with normal hearing. Remember that these values apply to reflex threshold measurements and that this instrument does not permit reflex threshold measurements due to the use of a hand-held probe. The presence of a reflex in the absence of a compliance peak suggests that the tympanometric results should be considered invalid and the test repeated. This is true because if there is no compliance measured during tympanometry, it is not possible to measure any stiffening affect during the reflex stimulus presentation.

### Abnormal

If a pressure leak occurs during the reflex testing and the pressure system is unable to correct for this leak, the reflex test sequence is aborted. When this occurs, the test results are assigned the letters NT (Not Tested).

If no response is obtained at the third and final stimulus level, the instrument will indicate this with the letters NR or No. More detailed testing at the frequency where this occurred is required to determine the reason for the no response.

## Audiometry

### Normal

A normal response from a child should be at or below 20 dB HL. A normal response from an adult is at or below 25 dB HL. Remember that these normal values assume a quiet environment during testing.

### Abnormal

In children, a failure to respond to a 20 dB HL (or lower) stimulus presentation during a retest performed four to six weeks after the initial test would indicate the need for more extensive diagnostic testing to determine the cause.

In adults, a failure to respond at or below 25 dB HL when the room noise levels are low indicates the need for more evaluation. However, the age and employment history of the individual must also be considered.

## Special Messages and Error Codes

Error code numbers and other special messages may be displayed on the screen or on the printout. These messages appear whenever an instrument error occurs or, in some instances, to apprise the operator of certain situations. For example, if there is no test result on the screen and the **Print Screen**  button is pressed, the printer will indicate "No Test To Print".

Error codes will appear as a two-digit number prefixed by the letter "E". If an error code appears, please repeat the operation that caused the error code to appear. If the error code appears for the second time, make a note of it and contact a Welch Allyn service representative, and give him/her the exact error code number.

## Sample Test Results

The following figures illustrate test results from sample TM286 Auto Tymp printouts. The smoothness of the tympanogram tracing is determined by the amount of movement during the testing. Little or no movement during the testing provides a smoother tracing. Moving, talking or crying during testing leads to a more erratic traces but does not dramatically affect the test results.

**Figure 20. 226 Hz Range of Normals**

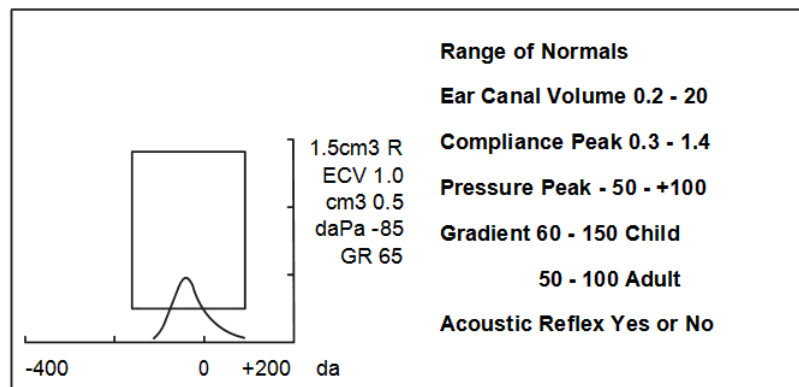

**Figure 21. 226 Hz Abnormal Tympanogram**

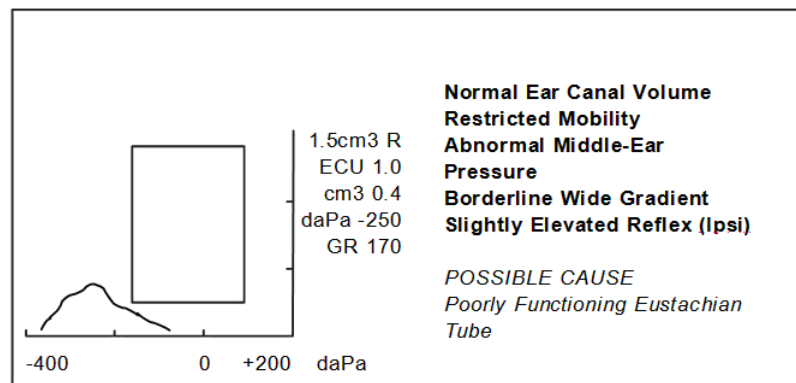

**Figure 22. 226 Hz Abnormal Tympanogram**

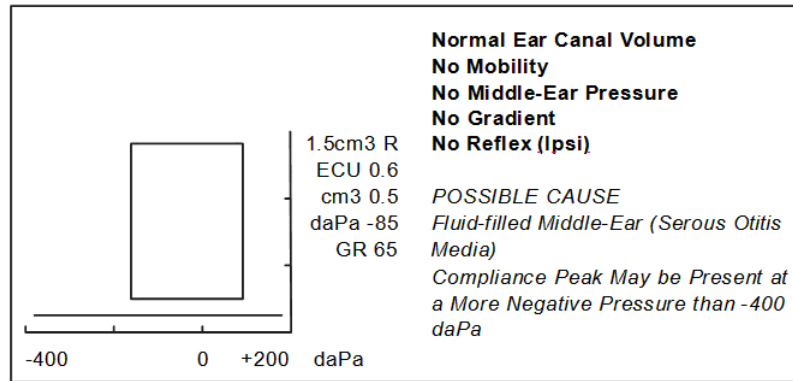

**Figure 23. 226 Hz Abnormal Tympanogram**

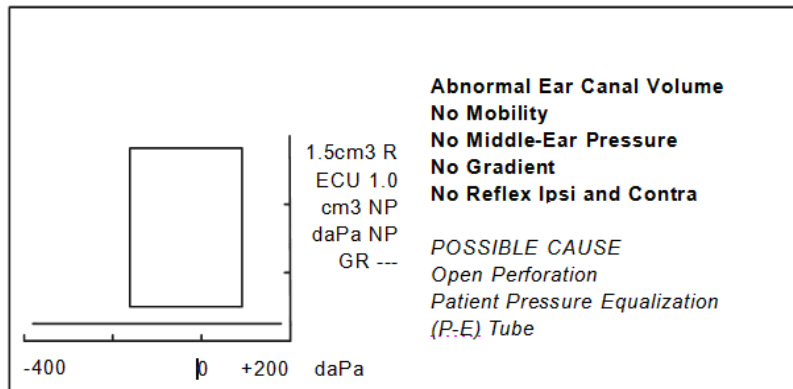

**Figure 24. 226 Hz Abnormal Tympanogram**

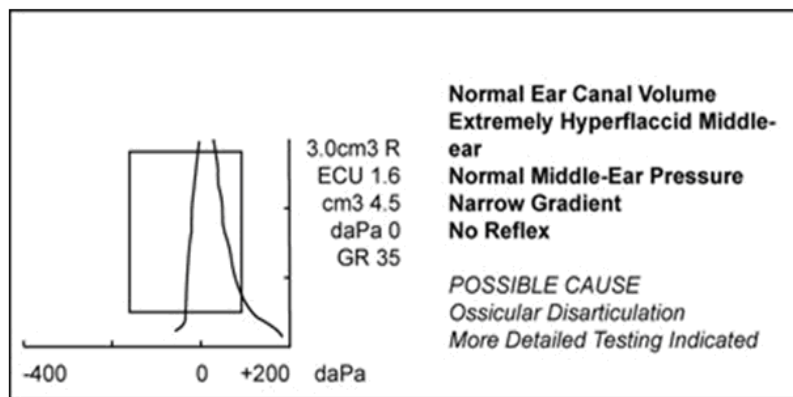



# 7 Computer Interface

## Introduction

The Computer Interface provides the capability of transferring stored test results from the instrument to an external computer or data collection device via a USB connection.



**WARNING** Accessory equipment connected to the analog and digital interfaces must be certified to the respective IEC standards (IEC 950 for data processing or IEC 60601-1 for medical equipment). Furthermore, all configurations shall comply with the system standard IEC 60601-1-1. Everyone who connects additional equipment to the signal input or signal output part configures a medical system, and is, therefore, responsible that the system complies with the requirements of the system standard IEC 60601-1-1. If in doubt, consult the technical service department or a local representative.

## Operation

Press the  button to transfer test results stored in memory. During data transfer, the message **DATA TRANSFER** will appear on the LCD screen.

### Transferring during normal operation

During normal testing operation, pressing the  button will transfer all stored test results sequentially.

### Transferring from memory pages

If the **PAGE** button is used to review individual test results stored in any of the 12 memory locations, the  button will transfer only the currently displayed stored test results. There is one exception to this rule: If the last (most recent) test result is displayed, the instrument assumes normal testing operation, and transfers all test results.

### Other LCD screen messages

#### INVALID SELECTION

This message appears if the  button is pushed during any of the following circumstances:

- During presentation of an audiometric tone
- During a tympanometry test
- During a reflex test

- During Printing

#### NO DATA AVAILABLE

This message appears if the  button is pressed and no results are stored.

#### NOT AVAILABLE

This message appears if the  button is pressed and the computer is not properly connected.

## Data Transfer Program Mode

The Data Transfer Program mode is used to modify the TM286 USB interface configuration parameters to match the computer's USB Port settings.

Enter the Program mode by selecting the **Program (PROG)** button. Move the cursor to **Data Xfer Config** and press the  button to enter the submenu.

The following screen appears the first time the Data Transfer Program mode is entered showing the factory default settings.



#### PROGRAM MODE - DATA TRANSFER



* 115.2 kBAUD	* NO PARITY + 8-BIT
57.6 kBAUD	ODD PARITY + 7-BIT
38.4 kBAUD	EVN PARITY + 7-BIT
19.2 kBAUD	SPC PARITY + 7-BIT
9600 BAUD	* XON/XOFF DISABLED
4800 BAUD	XON/XOFF ENABLED

These selections fall into three groups:

- Baud rate
- Parity and data bits
- Flow control

The default setting for each group has an asterisk (\*) before it so that it is easy to scan the settings for each group.

Selecting default settings for any of the groups is achieved in the same manner as the Program mode. Use the  or  buttons to move the solid square cursor down or up to the setting that you wish to select. Press the button. The word **SAVED** will appear in the lower right corner of the screen and the asterisk (\*) will appear in front of the new setting.

To exit the Data Transfer Program submenu, move the cursor to the  press the  button. This will return to the Program mode which can be exited by selecting **Program (PROG)**.

## Computer Interface

### Interface configuration

The configuration of the TM286 computer interface must be set to match the interface configuration of the computer. The TM286 defaults to 115 kBaud, no parity, 8 data bits, 2 stop bits and no communications flow control. The default settings for the baud rate, parity, number of data bits and flow control may be modified using the Data Transfer Program Mode explained earlier in this chapter.

### Cable connections

The computer interface provides a serial interface consisting of a USB connector.





# 8 Standards, Specifications, and Accessories

## Standards and Compliance

The TM286 meets

**Standards:**

UL 60601-1 Medical Electrical Equipment Requirements for Safety  
 IEC/EN 60601-1 General Requirements for Safety  
 CSA C22.2 No.601-1-M90  
 ANSI S3.39-1987 Aural Acoustic Impedance Admittance (Type 3)  
 IEC 60645-5 Aural Acoustic Impedance/ Admittance (Type 2)  
 ANSI S3.6-2004 Audiometers (Type 4)  
 IEC 60645-1 Pure Tone Audiometers (Type 4)  
 GL2005-00014 (ASHA 2005) Guidelines for Manual Pure-Tone  
 Threshold Audiometry

**Protective Classification:**

This system is intended for continuous operation and has a protective classification of Class 1.

Class 1 Type B 

## Tympanometry modes

**Probe Tone:** 226 Hz,  $\pm 2\%$

**Sound Pressure Level:** 226 Hz: 85.5 dB SPL,  $\pm 2.0$  dB, measured in a 2.0 cm<sup>3</sup> coupler

**Harmonic Distortion:** <3%

**Admittance (Compliance) Range:** 226 Hz: 0.0 to 1.5 cm<sup>3</sup> or 0.0 to 3.0 cm<sup>3</sup>

**Notes:**

1. The range is automatically selected based upon the amplitude of the compensated tympanogram.
2. The maximum uncompensated (ECV + tympanogram peak) admittance (compliance) range is 0 to 5.0 cm<sup>3</sup>.
3. ECV/cavity limits for initiating pressurization is 0.2 to 5.0 cm<sup>3</sup>.  
 Compliance Accuracy:  $\pm 0.1$  cm<sup>3</sup> or  $\pm 5\%$ , whichever is greater.

## Pneumatic System

**Pressure Range:** +200 to -400 daPa

**Notes:**

- 1 daPa = 1.02 mm H<sub>2</sub>O
- The pressure sweeps to at least -100 daPa. To save test time, pressure sweep stops when tympanogram returns to baseline after -100 daPa.
- Full pressure sweep for 5 cm<sup>3</sup> from sea level to 7000 ft. altitude with no leak.

**Pressure Accuracy:** ±10 daPa or ±15%, whichever is greater

**Rate of Sweep:** 600 daPa/sec except near tympanogram peak where sweep rate slows to 200 daPa/sec to provide better definition of peak compliance.

**Direction of Sweep:** Positive to negative

**Tympanogram Test Time:** Approximately 1 second

**Note**

High compliance tympanograms will take somewhat longer.

**Gradient:** Measurement of the tympanogram width taken at 50% of peak compliance.

## Acoustic Reflex Stimuli

**Frequencies:** 500, 1000, 2000, and 4000 Hz for ipsilateral stimulation

**Accuracy:** ±3%

**Total Harmonic Distortion:** <5% for outputs less than 110 dB HL and <10% at 110 dB HL

**Rise/Fall Time:** 5 to 10 msec

**Transducers**

**IPSILATERAL:** Probe Assembly

### Output Levels

**IPSILATERAL:** 500 and 4000 Hz: 80, 90, 100 dB HL  
1000 and 2000 Hz: 85, 95, 105 dB HL

**NOTES:**

- Ipsilateral stimuli are time multiplexed with probe tone (93 ms ON, 66 ms OFF).
- Stimuli are presented at lowest level first. If there is no response, the intensity is increased by 10 dB until a response is detected or the maximum dB HL is reached.

**Pressure:** Reflex measures are set automatically to pressure at peak compliance with an offset of -20 daPa if peak pressure is negative and +20 daPa if peak pressure is positive.

**Reflex Determination:** Compliance change of 0.05 cm<sup>3</sup> or greater.

**Reflex Test Time:** 1 to 12 seconds depending upon the number of ipsilateral test frequencies selected (4 maximum) and intensity required.

## Probe LED Indicators

<b>Probe:</b>	
<b>Steady yellow:</b>	Occlusion
<b>Blinking green:</b>	Ready to start
<b>Steady green:</b>	Test in progress
<b>Steady orange:</b>	Leak in pressure
<b>No Light:</b>	Test is finished

## Audiometry mode

<b>Frequencies:</b>	125, 250, 500, 750, 1000, 1500, 2000, 3000, 4000, 6000, 8000 Hz
<b>Accuracy:</b>	±2%
<b>Total Harmonic Distortion:</b>	< 2.5% (125 to 3000 Hz measured acoustically at maximum dB HL; 4000 and 6000 Hz measured electrically)

## Transducers

<b>Audiometric Headset</b>	Pair External Headset earphones Type 51 cushions (10 ohms impedance) Headband force per ANSI S3.6 and IEC 645 (4.5 ±0.5)
<b>Insert Earphones:</b>	Ear Tone Insert earphones (50 ohm impedance)

## Intensity Levels

### External Headset earphones

Frequency	Intensity
125 Hz	-10 to 50 dB HL
500 to 4000 Hz	-10 to 90 dB HL
6000 Hz	-10 to 85 dB HL
250 and 8000 Hz	-10 to 70 dB HL

### Note

An additional +10 dB is available per frequency via the +10 dB button.

<b>Accuracy:</b>	125 to 4000 Hz ±3 dB 6000 and 8000 Hz ±5 dB
<b>Step Size:</b>	5 dB
<b>Signal-to-Noise Ratio:</b>	> 70 dB in 1/3 octave; less than -10 dB HL for levels less than 60 dB HL
<b>Rise/Fall Time:</b>	20 to 50 msec

## Tone Format

	Tone is normally off until the Present bar is depressed
<b>Continuous</b>	Tone is steady when present bar is depressed
<b>Pulsed</b>	Tone is pulsed at 2.5/sec (i.e., 200 msec ON, 200 msec OFF)
<b>FM (frequency modulated)</b>	Tone is frequency modulated at a rate of 5 Hz, $\pm 5\%$

## Printer

<b>Paper Roll Length:</b>	Approximately 80 feet (960")
<b>Tests/Roll:</b>	Approximately 230 tests or 115 people
<b>Assumption:</b>	2 Tympanograms/Reflex + 1 Audiogram per person
<b>Speed:</b>	Approximately 1 minute to print three screens: Tympanogram Tympanogram + reflex (4) Audiogram
<b>External Printer:</b>	Optional Deskjet color printer recognizing PCL3 or PCL3 GUI; 8-1/2" x 11" or A4 format

## Power

Line Voltage:	100 - 240 VAC ( $\pm 10\%$ )
	<b>NOTE:</b> Desktop power supply
Frequency Range:	47 - 63 Hz
Power Consumption:	16 watts maximum while printing. Low voltage input for desktop power supplies 7 VDC, 5.0 A
Display:	240 x 64 graphical, monochrome LCD

## Environmental

Operating Temperature	59° F to 104° F (15° C to 40° C)
Warm-up Time:	10 minutes for instruments stored at room temperature
Storage/Shipping:	-30° F to 149° F (-34° C to 65° C)
Ambient Pressure:	98 kPa to 104 kPa
Humidity:	15% to 95%

# Mechanical

## Instrument

Dimensions:	12.5" W x 14.5" D x 4.7" H 31.8 cm W x 36.8 cm D x 11.9 cm H
Weight	5 lbs (2.3 kg) - unit and probe

## Shipping Carton

Dimensions:	19.5" W x 22.5" D x 8.25" H 49.5 cm W x 57.2 cm D x 20.9 cm H
Weight	13.1 lbs (6 kg)

# Head set

DD45 External Headset Earphones with Type 51 Cushions (10 ohm impedance).

Headband	Exerts a force between 4 and 5 N when the earphones are separated by 145 mm.
----------	--

# Electromagnetic Compatibility

## Electromagnetic compatibility (EMC)

Please refer to the Electromagnetic Compatibility Reference Guide on CD (part number 482-6387xx) for EMC information concerning your system.

# Accessories

<b>Welch Allyn Part Number</b>	<b>Welch Allyn Description</b>
05260-U	TM Carrying Case
23220	Audiometry Patient Response Switch
23221	Audiometry Single Patch Cord, 2-Conductor
23222	Audiometry AudioCups
26008	TM Eartips 8 mm (1box of 25)
26011	TM Eartips 11 mm (1box of 25)
26013	TM Eartips 13 mm (1box of 25)
26015	TM Eartips 15 mm (1box of 25)
26017	TM Eartips 17 mm (1box of 25)
26019	TM Eartips 19 mm (1box of 25)
26100	TM Eartips ( 6 sizes, 2 each)
26240	TM Dust Cover
26241	TM Test Cavity
28203	DD45 Audiometry Headset External
28206	Threshold Audiometry Card
28601	TM286 Power Brick
28602	TM286 Cord, Power, Hosp Gade
28603	TM286 Directions for Use Manual (printed, English only)
28604	TM286 Quick Reference Guide
28605	TM286 Directions for Use Manual (printed, French only)
28607	TM Wall Chart for Tymp tracings
52600	TM Printer Paper, 4" Thermal, 5 rolls

## Bibliography

American Speech-Language-Hearing Association (1990). "Guidelines for Screening for Hearing Impairment and Middle Ear Disorders". ASHA, 32 (Suppl.2), 17-24.

Criteria for Permissible Ambient Noise During Audiometric Testing (ANSI S3.1 - 1977) de Jonge, R.R. (1986). "Normal Tympanometric Gradient: A Comparison of Three Methods". *Audiology*, 26, 299-308.

Koebsehl, K.A. & Margolis, R.H. (1986). "Tympanometric Gradient Measured from Normal Pre-School Children", *Audiology*, 25, 149-157.

Margolis, R.H. & Heller, J.W. (1987). "Screening Tympanometry: Criteria for Medical Referral". *Audiology*, 26, 197-208.

Margolis, R.H. & Shanks, J.E., "Tympanometry". In Katz, J.(Ed.),. *Handbook of Clinical Audiology*, Ed.3., Baltimore: Williams & Wilkins, 1985.

Margolis, R. H., Bass-Ringdahl, S., Hands, W., Holte, L. and Zapala, D. A. (2003) "Tympanometry in Newborn Infants - 1 kHz Norms" *Journal of the America Academy of Audiology*, 14 (7), 383-392.

Michael, P.L. and Bienvenue, G.R., "Noise Attenuation Characteristics of Supra-Aural Audiometric Headsets using the Models MX41/AR and 51 Earphone Cushions," *J.Acoust.Soc.Am.*, 70(5), Nov.1981, 1235-1238.

Methods for Manual Pure-Tone Threshold Audiometry (ANSI S3.21 1978). Newby, H.A., *AUDIOLOGY* (4th Ed.). New Jersey: Prentice-Hall Inc. (1979).

Paradise, J.L., Smith, C.G., Bluestone, C.D.(1976). "Tympanometric Detection of Middle Ear Effusion in Infants and Young Children", *Pediatrics*, 58 (2), 198-210.

U.S. Department of Labor, Occupational Noise Exposure, CFR 1910.95, March 8, 1983.

