

BLICKMAN



Cabinets & Casework

Customizable, secure, and organized

Includes:

- Freestanding Cabinets
- Customizable Casework
- Sinks and Countertops
- Console Cabinets
- Accessories and Options



OUR MISSION

Customer Focus

Exceed customer expectations through a commitment to continuous improvement of our products and services.

Quality Products

Offer the marketplace a broad range of high quality, cost effective, and durable products of superior craftsmanship.

Organizational Excellence

Strive for excellence in all we do by fostering a participative, team based environment, which nurtures the active involvement of all members of the organization.

Marketplace Recognition

Earn the respect, admiration, and loyalty of our people, customers, and suppliers by treating them with dignity and respect, embracing diversity, and developing and maintaining long term partnerships.

Collaborative Workplace

Encourage all employees to work safely and efficiently, contribute innovative ideas, and personally benefit from the ongoing success of the company.

BLICKMAN

THE BLICKMAN DIFFERENCE

Freestanding Cabinets

- Our stainless steel cabinets are constructed with a seamless welded face preventing dirt collection while providing long lasting durability through unparalleled strength and corrosion resistance.
- Our freestanding cabinets rest on four legs with glides or can be mobilized on casters.
- Add a sloped top to prevent dirt collection to create a sterile environment.
- Kay and Kennedy cabinets feature two separate sections with unlocked or locked compartments.
- Paul and Walter cabinets provide maximum storage room for large equipment.

Key Product Features

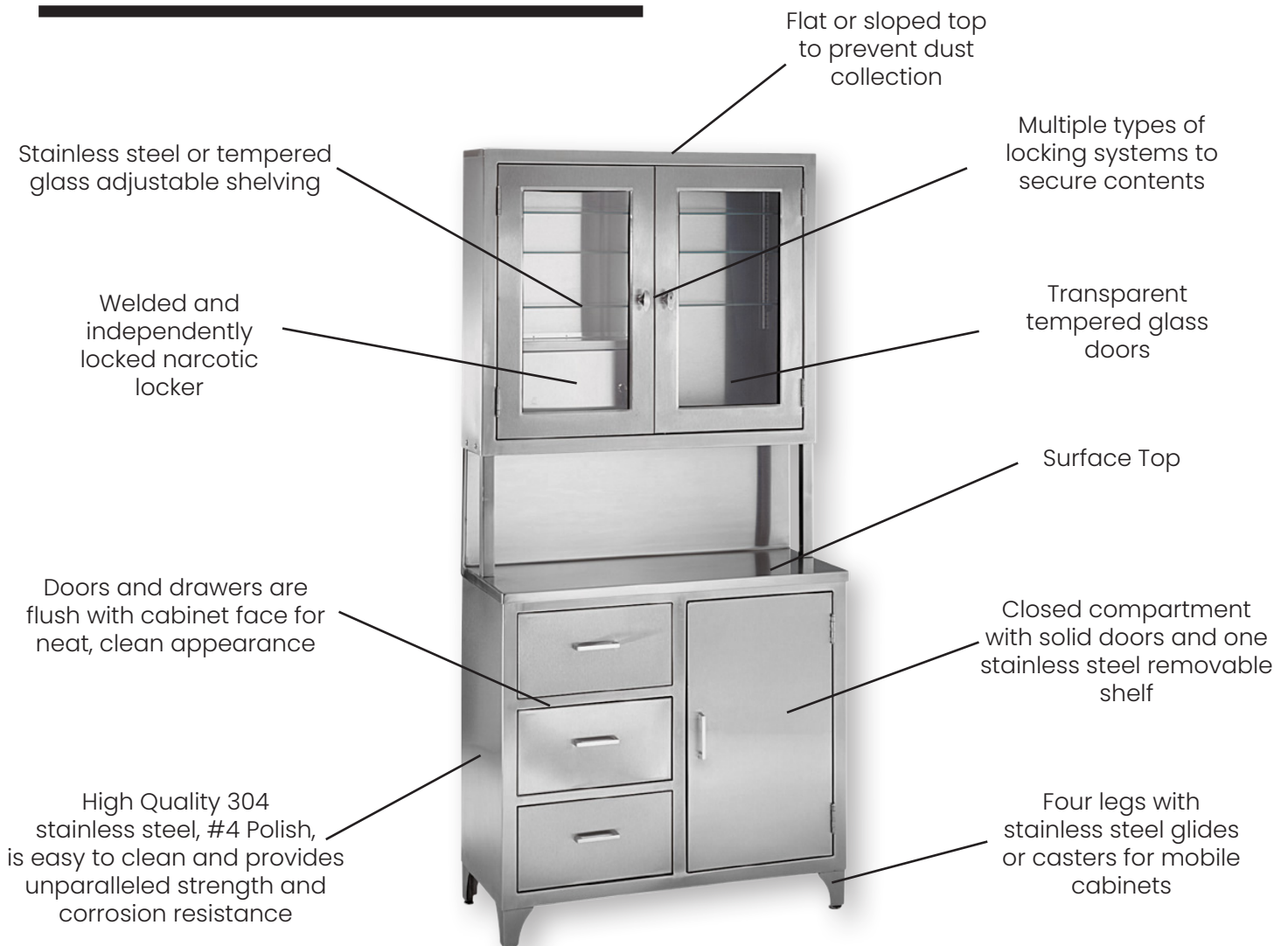

Cabinets

Freestanding

FREESTANDING

Description: Our Kay and Kennedy freestanding cabinets feature separate upper and lower sections. The upper sections of these cabinets are locked, transparent compartments for easily viewing and securing contents. The Kennedy cabinet includes an independently locked and welded narcotic locker.



Kay Cabinet

Upper section: Consists of a locked 29 3/4" x 31 3/8" x 15" compartment with a glass door and three removable glass shelves

Lower section: Consists of a 29 3/4" x 20 1/2" x 15" compartment with a stainless steel door and one stainless steel shelf



Kennedy Cabinet

Upper Section: 8" deep and contains a welded and independently locked narcotic locker

Lower Section: 16" deep and contains three 7" deep drawers and one 15" deep compartment

Name	Kay	Kennedy
Dimensions (WxHxD)	30" x 58" x 16"	36" x 76 1/2" x 16"
Model #	7953SS	7956SS
Item #	1517953000	1527956000
Shipping Weight	219 lbs.	291 lbs.

Options: 2 "Casters, stainless steel shelves for upper cabinets, sloping top, all stainless steel doors

Custom Designs Available Upon Request
Please email us at info@blickman.com

Cabinets

Freestanding

FREESTANDING

Description: Our Paul and Walter cabinets are double door freestanding cabinets. They each come standard with two glass locked doors for securing contents. Our Walter cabinet is ideal for storing large instruments on its back pegboard, while our Paul cabinet includes shelving for storing lots of instruments and supplies. They are both 16" deep and 76" tall on gliders. They are 79 1/4" tall on casters. Choose from two standard width sizes: 35 5/8" and 47 5/8".



Walter Cabinet

This cabinet is great for storing endoscopy equipment or other large instruments on its pegboard



Paul Cabinet

This cabinet provides maximum shelving storage for instruments and supplies. Glass shelves are adjustable every 1/2"

Name	Walter		Paul	
Width	35 5/8"W	47 5/8"W	35 5/8"W	47 5/8"W
Model #	7959SS	7960SS	7970SS	7971SS
Item #	1537959000	1537960000	1537970000	1537971000
Shipping Weight	269 lbs.	310 lbs.	330 lbs.	400 lbs.

Options: Glides or casters, recessing, flat top, stainless steel shelves (Paul Cabinet), all stainless steel doors

Custom Designs Available Upon Request

Please email us at info@blickman.com

Cabinets

FREESTANDING
Options &
Accessories

OPTIONS

Foot Options



Locking Casters



Casters



Gliders

Recessed Options

*For more information see Console Cabinets Section.



Recessed Paul



Recessed Walter

ACCESSORIES



Electronic Locking Systems, available for most of our cabinets



Additional Shelves, your choice of stainless steel or glass



Sloped top (see order details below)

Model #	Item #	Description	Shipping Weight
ST-3016	4503516300	Sloped Top for Kay (30" x 6" x 16")	35 lbs.
ST-3608	4503536080	Sloped Top for Kennedy (36" x 6" x 8")	37 lbs.
ST-3516	4503516350	Sloped Top for Walter or Paul (slim) (35 5/8" x 6" x 16")	43 lbs.
ST-4716	4503516470	Sloped Top for Walter or Paul (wide) (47 5/8" x 6" x 16")	54 lbs.

Cabinets

FREESTANDING
Construction
Specifications

Construction Specifications

Standard Dimensions	All Freestanding Cabinets: 16" deep
Materials	304 stainless steel 1/4" clear tempered sheet glass
Gauge	Body, Sloped Top, Drawers, and Shelf Inserts: 18GA; Legs: 12GA Glass Doors (Front and Back): 18GA Solid Doors (Front): 18GA; Solid Doors (Back): 20GA
Welding	All welding by heliarc method and exposed welds are ground smooth
Finish	Exposed surfaces are free from pit marks, weld seams, scale and are polished with #4 polish to a satin finish
Casters	2" or 3" ball bearing, swivel casters with brakes
Notes	<ul style="list-style-type: none">• Kay: A counter weight is fastened underneath at bottom rear of cabinet for doors in open position. Upper door fitted with lock handle and three way latching device engaging at top.• Kennedy: Right hand door equipped with a locking knob and three way latching. Left hand door with dummy knob and roller latch. An independently locked narcotic cabinet, 13 1/4" x 5" x 7 3/4" with double walled door is welded to the bottom, back, and side of the compartment.• Paul & Walter: A counter weight is fastened underneath at bottom rear of cabinet for doors in open position. Right hand door is fitted with a locking handle and three point latching, and the left door has a dummy knob and spring loaded nylon roller catches.

Shipping Information

All shipping weights are estimates and may be changed without prior notice. Specifications may be improved and dimensions changed without prior notice. Please contact customer service for estimated shipping costs at info@blickman.com.

THE BLICKMAN DIFFERENCE

Casework

- Need more flexibility in today's space squeezed environment? We provide you with casework that can be assembled together and modified to fit your custom dimensions.
- Whether it is renovation or new construction, we will be happy to work with your facility's personnel, architects, contractors, and/or equipment planners to meet your custom requirements.
- Utilizing 3D Design Software REVIT®, we have developed a library of our standard products which is available at no charge to your company. Our 3D library will save you considerable time and money when working on projects that require stainless steel cabinets and equipment.
- Each product line of cabinets (console cabinets, high cabinets, base cabinets, and wall cabinets) have their individual properties identified for easy customization: (cubic feet, weight, "X", "Y" and "Z" dimensions, voltage, etc.).

Key Product Features

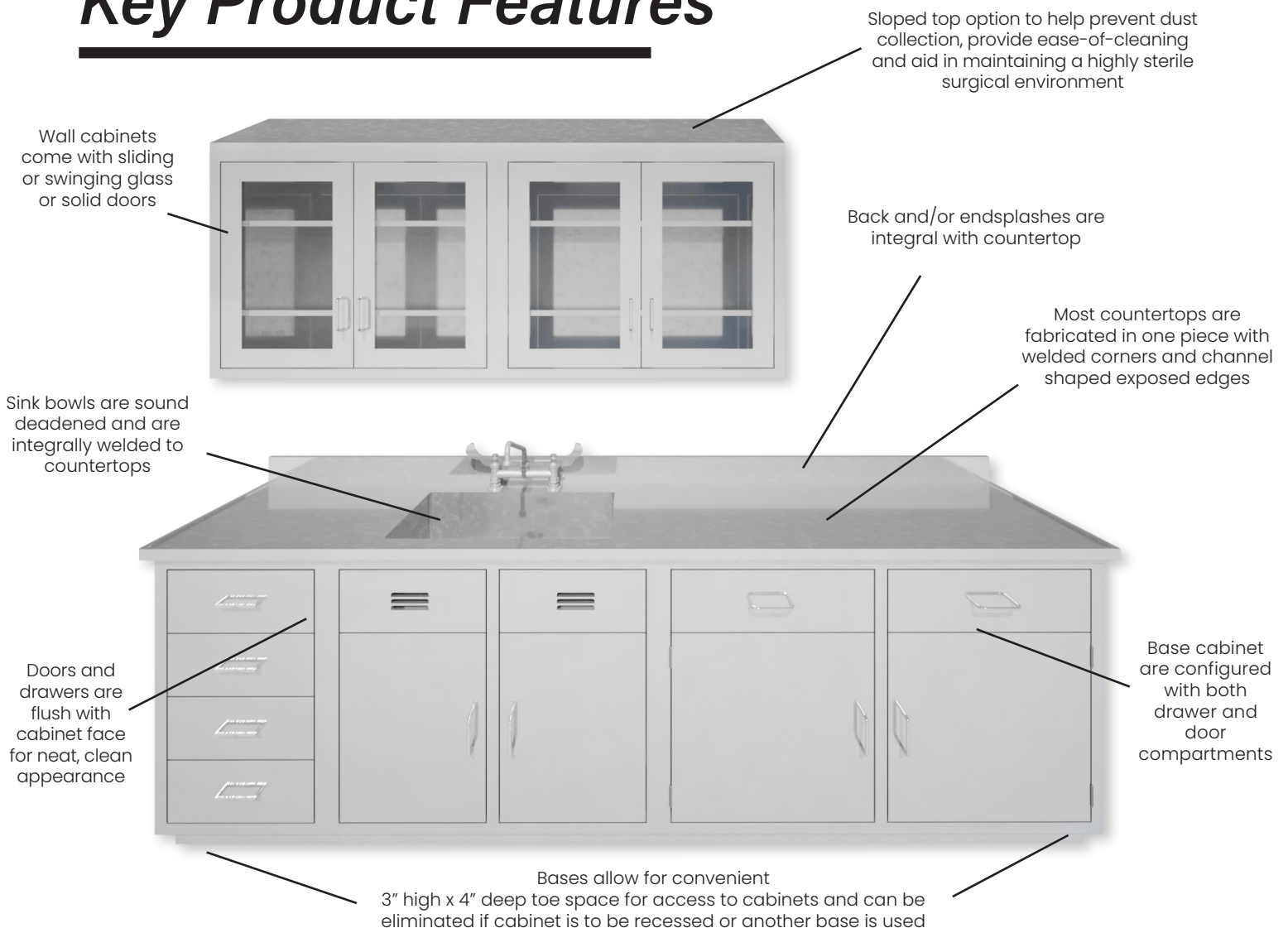

Cabinets

Customizable
Casework

HIGH CABINETS

Description: Our stainless steel high cabinets are designed to stand alone or fit within a framework of cabinets. They are constructed as floor and wall supported individual cases with finished sides. They each contain five adjustable stainless steel shelves, with the option of glass shelves and additional shelves. They are all 84" tall and 18" deep cabinets. Width varies and other alternative dimensions are available.

Customize the widths and depths of these models to your room.

- Common Dimensions:**
- Single Door: 24 3/4" W
 - Double Door: 29", 41", and 47"W
 - Alternative Depth: 23"D

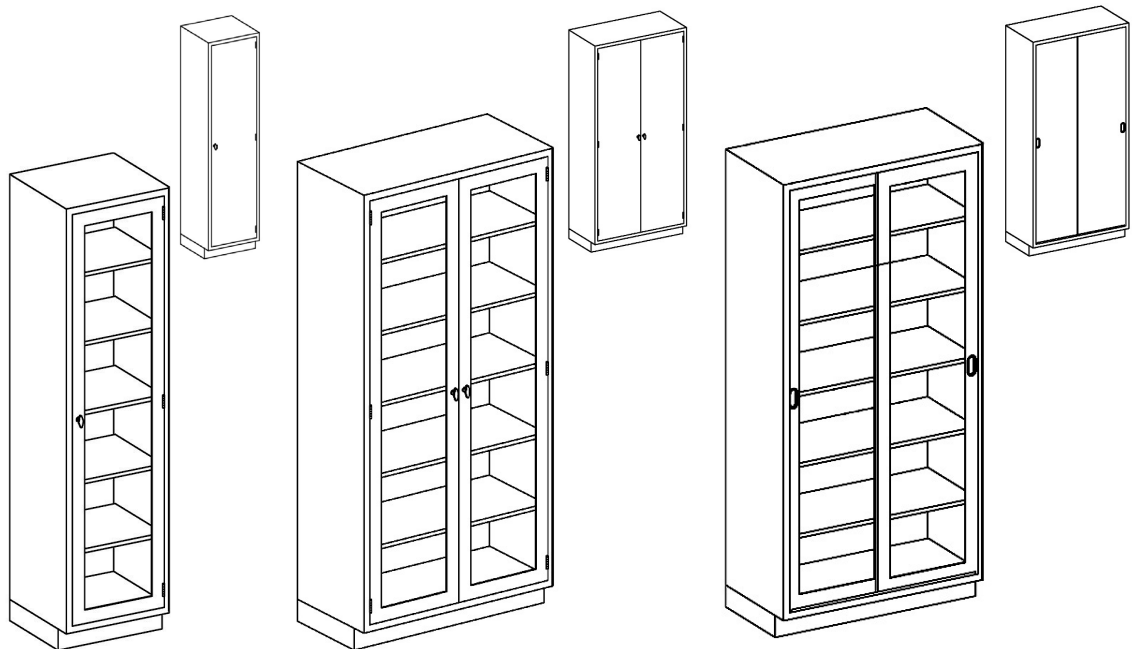

Name	Single Door	Double Door	Double Sliding Doors
		Glass Doors	
Dimensions (WxHxD)	18 3/4" x 84" x 18"	35" x 84" x 18"	35" x 84" x 18"
Model #	K18HAS	L35HAS	M35HAS
Item #	2030518000	203053500	2030635000
Shipping Weight	215 lbs.	310 lbs.	325 lbs.
		Solid Stainless Steel Doors	
Dimensions (WxHxD)	18 3/4" x 84" x 18"	35" x 84" x 18"	35" x 84" x 18"
Model #	H18HAS	I35HAS	J35HAS
Item #	2030418000	2030435000	2030535180
Shipping Weight	230 lbs.	300 lbs.	347 lbs.

Options: Sloped top, glass shelves, additional shelves

Custom Designs Available Upon Request
Please email us at info@blickman.com

Cabinets

Customizable
Casework

WALL CABINETS

Description: Our stainless steel wall cabinets are designed to stand alone with finished sides or to fit within a framework of cabinets. They are constructed for flush face wall surfaces with a recessed back panel for uneven wall surfaces. Each cabinet comes with two 1/2" adjustable stainless steel shelves. Choose from swinging or sliding doors made of either solid stainless steel or glass. Our wall cabinets are all 30" tall and 13" deep. Width varies and other alternative dimensions are available.

Customize the widths and heights of these models to your room.

- Common Dimensions:**
- Single Door: 18 3/4" and 24 3/4" W
 - Double Door: 29", 35", 41", and 47"W
 - Alternative Heights: 36" and 48"H

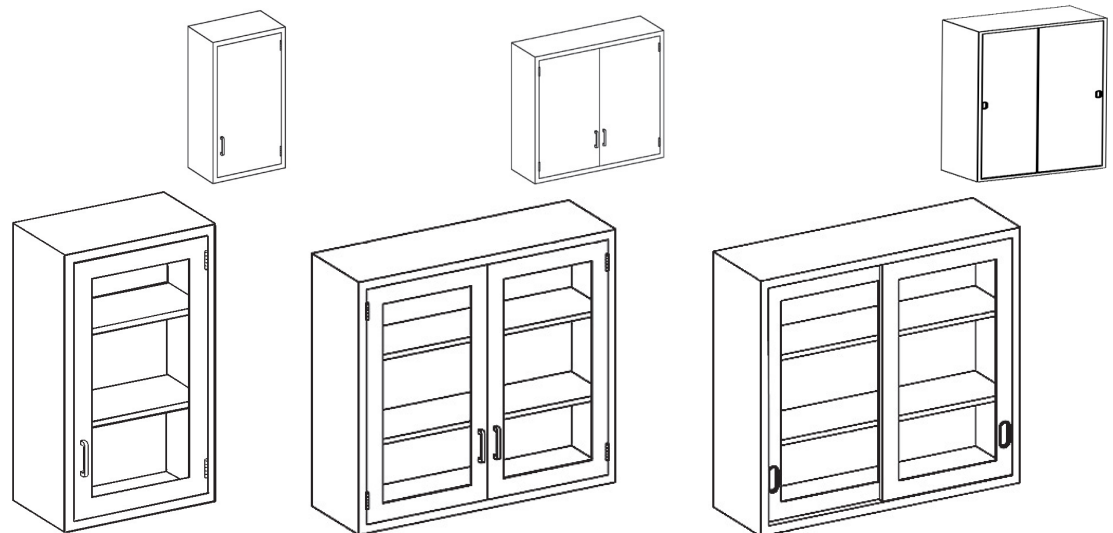

Name	Single Door	Double Door		Sliding Doors
		Glass Doors		
Dimensions (WxHxD)	18 3/4" x 30" x 13"	35" x 30" x 13"		35" x 30" x 13"
Model #	D18LS	E35LS		F35LS
Item #	2020318000	2020335000		2023035000
Shipping Weight	95 lbs.	145 lbs.		135 lbs.
Solid Stainless Steel Doors				
Dimensions (WxHxD)	18 3/4" x 30" x 13"	35" x 30" x 13"		35" x 30" x 13"
Model #	A18LS	B35LS		C35LS
Item #	2020218000	2020235000		2023135000
Shipping Weight	90 lbs.	141 lbs.		130 lbs.

Options: Sloped top, glass shelves, additional shelves

Custom Designs Available Upon Request
Please email us at info@blickman.com

Cabinets

Customizable
Casework

OPEN WALL SHELVES

Description: Our stainless steel open wall cabinet is designed to stand alone with finished sides or fit within a framework of cabinets and comes with two adjustable stainless steel shelves. Alternatively, we offer a wall shelf that can be placed anywhere along a wall.

Common Dimensions:

- Wall Cabinet Widths: 29" and 41", Heights: 36" and 48"
- Wall Shelf Widths: 48", 60", and 72", Depths: 16"

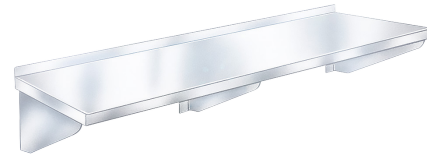
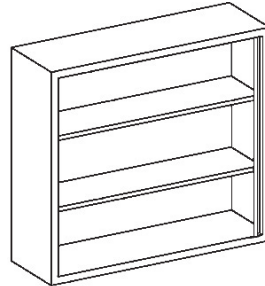

Name	Open Wall Cabinet		Wall Shelf	
Width	35" W	47" W	36" W	84" W
Dimensions (WxHxD)	35" x 30" x 13"	47" x 30" x 13"	36" x 12"	84" x 12"
Model #	G35LS	G47LS	WS3612	WS8412
Item #	2020435000	202044700	1813612000	1818412000
Shipping Weight	75 lbs.	142 lbs.	26 lbs.	40 lbs.

OPEN BASE CABINETS

Description: Our stainless steel open base cabinets offer open shelving to fit within a framework of cabinets or stand alone with finished sides. They are constructed for flush face wall surfaces and come with two adjustable stainless steel shelves. Our open base cabinets are all 22" deep and 35 3/4" high and come in a variety of width sizes.

Other Commonly Ordered Double Width Sizes: 29"W and 41"W

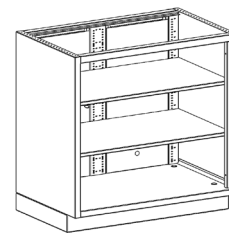
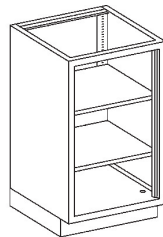

Name	Single Width		Double Width	
Width	18 1/8" W	24 1/8" W	35" W	47" W
Model #	AJ18HS	AJ24HS	AJ35HS	AJ47HS
Item #	2012518000	2012524000	2012535000	2012547000
Shipping Weight	102 lbs.	122 lbs.	152 lbs.	170 lbs.

Custom Designs Available Upon Request
Please email us at info@blickman.com

Cabinets

Customizable
Casework

SINGLE BASE CABINETS

Description: Our stainless steel single width base cabinets come in five different configurations and are designed to stand alone with finished sides or to fit withing a framework of cabinets. They are all 35 3/4" tall and 22" deep, and come in two width sizes, 18 1/8" and 24 1/8".

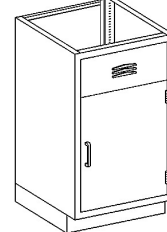
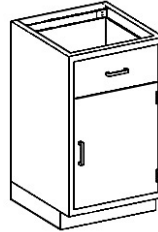
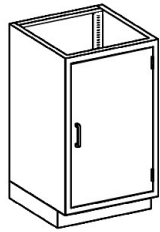

Name	-AA- Door	-AB- Door, Drawer	-AC- Door, Vent (Sink)
	18 1/8" Wide		
Model #	AA18HS	AB18HS	AC18HS
Item #	2012118000	2012218000	2012218001
Shipping Weight	80 lbs.	125 lbs.	107 lbs.
	24 1/8" Wide		
Model #	AA24HS	AB24HS	AC24HS
Item #	2012224000	2012124000	2012224001
Shipping Weight	132 lbs.	147 lbs.	118 lbs.

Note: Cabinets without vents include one stainless steel shelf inside

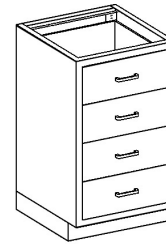
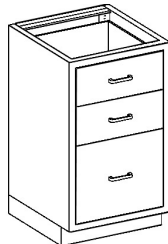

Name	-AS- 3 Drawer	-AE- 4 Drawer
	18 1/8" Wide	
Model #	AS18HS	AE18HS
Item #	2012718000	2012318000
Shipping Weight	167 lbs.	174 lbs.
	24 1/8" Wide	
Model #	AS24HS	AE24HS
Item #	2012724000	2012324000
Shipping Weight	183 lbs.	192 lbs.

Note: Cabinets without vents include one stainless steel shelf inside

Custom Designs Available Upon Request
Please email us at info@blickman.com

Cabinets

Customizable
Casework

DOUBLE BASE COMPARTMENT CABINETS

Description: Our stainless steel double base compartment cabinets come in seven different configurations and are designed to stand alone with finished sides or to fit within a framework of cabinets and. They are all 35 3/4" tall and 22" deep, and come in two width sizes, 35" and 47".

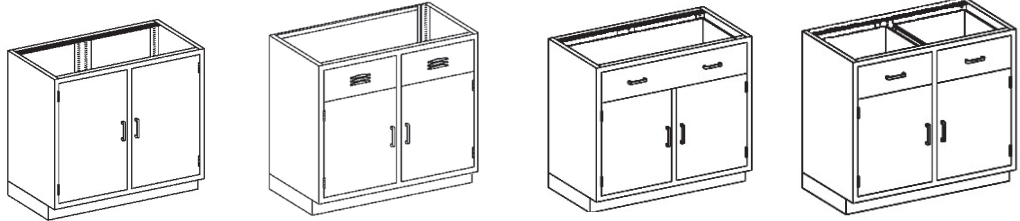

Name **-DA-
Double Door** **-DB-
Double Vent (Sink)** **-DC-
Large Drawer** **-DD-
Double Drawer**

35" Wide

Model #	DA35HS	DB35HS	DC35HS	DD35HS
Item #	2013235200	2013235000	2013235001	2013335000
Shipping Weight	161 lbs.	145 lbs.	200 lbs.	194 lbs.

47" Wide

Model #	DA47HS	DB47HS	DC47HS	DD47HS
Item #	2013247200	2013247000	2013247001	2013347000
Shipping Weight	205 lbs.	178 lbs.	235 lbs.	243 lbs.

Note: Cabinets without vents include one stainless steel shelf inside



Name **-DG-
1 Door, 4 Drawer** **-DJ-
1 Door, 8 Drawer** **-DK-
1 Door, 5 Drawer**

35" Wide

Model #	DG35HS	DJ35HS	DK35HS
Item #	2013435000	2013535001	2013535000
Shipping Weight	180 lbs.	225 lbs.	257 lbs.

47" Wide

Model #	DG47HS	DJ47HS	DK47HS
Item #	2013447000	2013547001	2013547000
Shipping Weight	282 lbs.	280 lbs.	283 lbs.

Note: Cabinets without vents include one stainless steel shelf inside

Custom Designs Available Upon Request
Please email us at info@blickman.com

Cabinets

Customizable
Casework

DOUBLE BASE DRAWER CABINETS

Description: Our stainless steel double base drawer cabinets come in five different configurations and are designed to stand alone with finished sides or to fit within a framework of cabinets. They are all 35 3/4" tall and 22" deep, and come in two width sizes, 35" and 47".

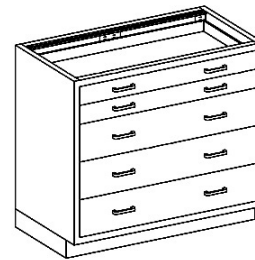

Name

**-DP-
4 Drawer**

**-DS-
5 Drawer**

35" Wide

Model #	DP35HS
Item #	2013735000
Shipping Weight	238 lbs.

Model #	DS35HS
Item #	2013735001
Shipping Weight	275 lbs.

47" Wide

Model #	DP47HS
Item #	2013647000
Shipping Weight	276 lbs.

Model #	DS47HS
Item #	2013747001
Shipping Weight	315 lbs.



Name

**-DT-
8 Drawer**

**-DR-
4 Small, 2 Large**

**-FC-
6 Small, 2 Large**

35" Wide

Model #	DT35HS
Item #	2013835000
Shipping Weight	287 lbs.

Model #	DR35HS
Item #	2013635000
Shipping Weight	265 lbs.

Model #	FC35HS
Item #	2013235002
Shipping Weight	275 lbs.

47" Wide

Model #	DT47HS
Item #	2013847000
Shipping Weight	324 lbs.

Model #	DR47HS
Item #	2013747000
Shipping Weight	310 lbs.

Model #	FC47HS
Item #	2013247002
Shipping Weight	323 lbs.

Custom Designs Available Upon Request
Please email us at info@blickman.com

Cabinets

Customizable
Casework

SINKS AND COUNTERTOPS

Please email us at info@blickman.com

Sink bowls come with moisture proof, sound-deadening mastic and are compatible with select base cabinets

Optional back/endsplashes (4" high) to protect wall surfaces



Counter top extends 1" past the front and past both sides of the base cabinet dimensions

Counter top is 304 stainless steel and comes standard with a Marine Edge to help protect against liquid spillage

Description: Our sinks and countertops must be ordered separately and are installed in the field. Most of our countertops are fabricated from one piece of fully welded, 16 gauge, 304 stainless steel. They extend 1" beyond the front, right, and left sides of base cabinet dimensions. Unless otherwise specified, they come with a Marine Edge to help protect against liquid spillage. Optionally, 4" high backsplashes and endsplashes are available to protect wall surfaces.

Base Cabinets Compatible with Additional Sink Bowl

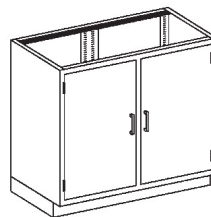
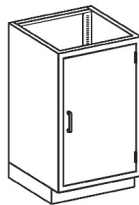

AC

DB

AA

DA

DG

DJ

We suggest using Models AC and DB for moisture ventilation.

All piping and sink bowls can fit under any of these models with the door compartments and no drawers on top.

Cabinets

Customizable
Casework

DRAWER HOUSING

Please email us at info@blickman.com

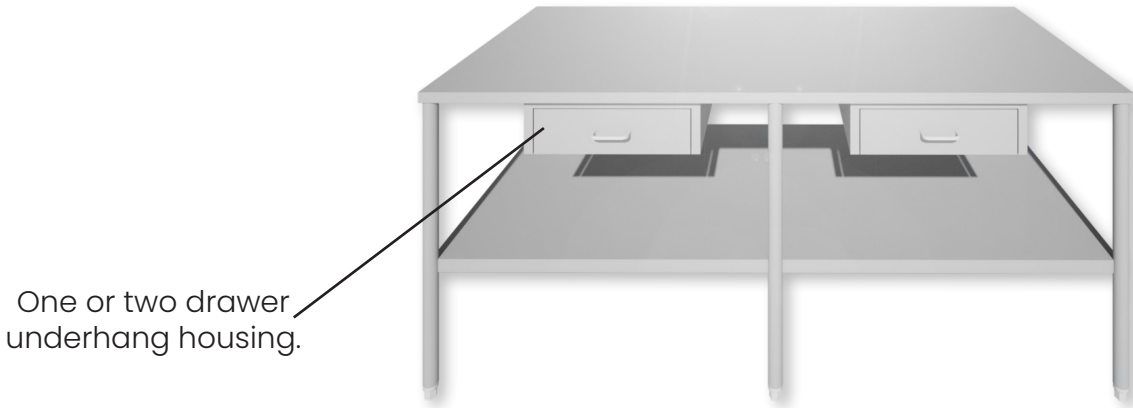

Description: You can use drawer housing to add a drawer or two under your countertop or tabletop surface. This helps increase storage space to prevent lack of access to equipment and supplies when stored separately.

All drawer housing is 22" deep and reaches 5" below the underside of the countertop or tabletop. Width of drawer housing varies depending on size and number of drawers inside. The drawers are all 18 1/8" deep and 2 1/2" tall and come in two width sizes: 14 1/8" and 20 1/8".

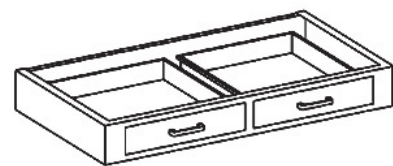
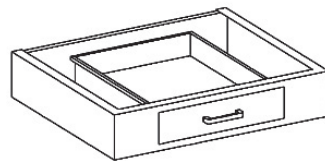

Name Drawer & Housing Widths	Single Drawer		Double Drawer	
	14 1/8" W Drawer 24" W Housing	20 1/8" W Drawer 29" W Housing	14 1/8" W Drawer 35" W Housing	20 1/8" W Drawer 47" W Housing
Model #	DH124S	DH129S	DH235S	DH247S
Item #	2043424000	2043429000	2043435000	2043447000
Shipping Weight	35 lbs.	40 lbs.	50 lbs.	60 lbs.

Custom Designs Available Upon Request

Please email us at info@blickman.com

Cabinets

CASEWORK
Options &
Accessories

OPTIONS



Sloped Top is available for all High Cabinets and Wall Cabinets. Listed below are the sloped tops that correspond to the cabinets with the standard dimensions shown in this previously in this section.

Model #	Item #	Description	Shipping Weight
ST-1818	5003518180	Sloped Top for 18 ³ / ₄ " W High Cabinets (18 ³ / ₄ " x 11 ¹ / ₄ " x 18")	24 lbs.
ST-3518	5003535180	Sloped Top for 35" W High Cabinets (35" x 11 ¹ / ₄ " x 18")	41 lbs.
ST-1813	5003518130	Sloped Top for 18 ³ / ₄ " W Wall Cabinets (18 ³ / ₄ " x 8 ¹ / ₄ " x 13")	21 lbs.
ST-3513	5003535130	Sloped Top for 35" W Wall Cabinets (35" x 8 ¹ / ₄ " x 13")	36 lbs.

ACCESSORIES



Electronic Locking Systems available for most of our cabinets

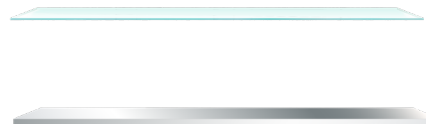

Additional Shelves, your choice of stainless steel or glass

Custom Designs Available Upon Request

Please email us at info@blickman.com

Cabinets

Construction Specifications

Standard Dimensions	High Cabinets: 84" tall x 18" deep, widths vary Wall Cabinets: 30" tall x 13" deep, widths vary Base Cabinets: 35 3/4" tall x 22" deep, widths vary Countertops: 1" overhang in front and both sides of base cabinets
Materials	304 Stainless Steel 1/4" clear tempered sheet glass
Gauge	Body, Sloped Top, Drawers, and Shelf Inserts: 18GA; Base: 16GA Glass Doors (Front and Back): 18GA Solid Doors (Front): 18GA; Solid Doors (Back): 20GA
Welding	All welding by heliarc method and exposed welds are ground smooth
Finish	Exposed surfaces are free from pit marks, weld seams, scale and are polished with #4 polish to a satin finish
Casters	N/A
Notes	<ul style="list-style-type: none">• Cabinet Parts:<ul style="list-style-type: none">◦ Hinge Doors: Hung on semi concealed stainless steel hinges and fitted with die cast aluminum bar pulls and spring loaded nylon roller catches.◦ Sliding Doors: Suspended from overhead ball bearing rollers, which are noiseless and self-lubricating, and ride in stainless steel guide strips fitted with die formed, recessed pulls securely welded in place.◦ Shelves: Constructed with a channel shaped, flanged edge and centers the full height of the cabinet.◦ Drawers: Drawer bodies are a one piece construction with covered corners. Drawer face equipped with die cast aluminum bar pole handles. Drawers operated on ball bearing roller slides with full extension.• High Cabinets & Wall Cabinets: Recessed pan back, 3/4" deep.• Base Cabinets: Each applied with a channel shaped base, incorporating toe space approximating 3" deep and 4" high, for easy cabinet access. Can be omitted when recessed or another base is used.• Sinks and Countertops: Fabricated in one piece, where possible, with welded corners, channel shaped exposed edges, and reinforced with three full length hat shaped galvaneal channels.

Shipping Information

All shipping weights are estimates and may be changed without prior notice. Specifications may be improved and dimensions changed without prior notice. Please contact customer service for estimated shipping costs at info@blickman.com.

THE BLICKMAN DIFFERENCE

Console Cabinets

- Our console cabinets are designed with you in mind. Choose these cabinets for storage for a full scheduled day, to protect your sterile supplies behind closed doors, and have instant access to supplies and equipment to minimize procedural delays.
- We offer individual units that can be combined and assembled into your own custom console arrangements. You can easily design your own by selecting cabinets with solid or glass doors available with or without locks. Locks can be keyed alike or independently.
- Our cabinets can also be furnished as freestanding cabinets on glides, casters, or bases with or without sloped tops to prevent dust collection.
- Stainless steel perimeter recessing trim may be purchased with all built-in installations.

Key Product Features

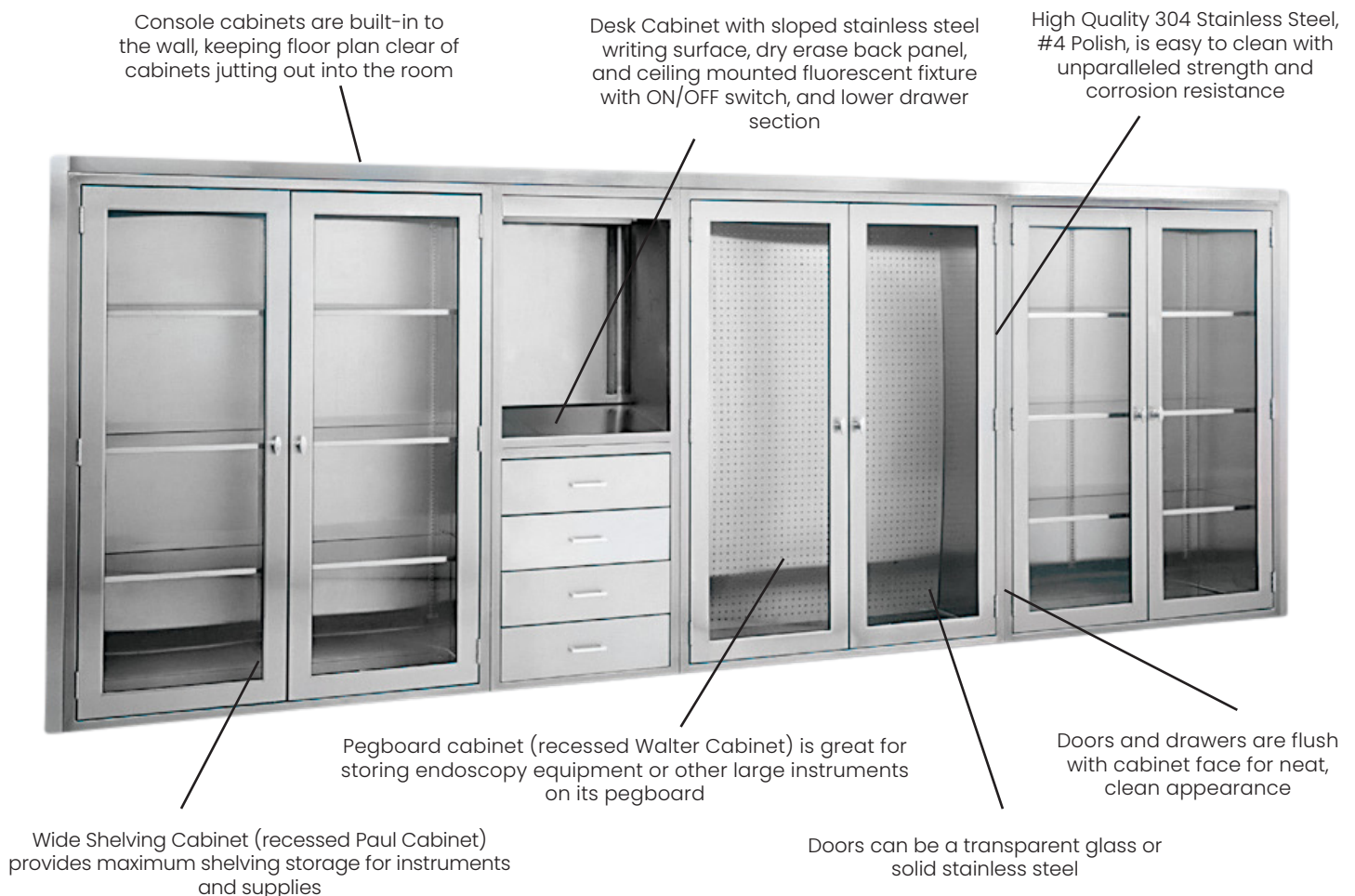

Cabinets

Console Cabinets

SINGLE WIDTH

Description: Our single width console cabinets are all designed as individual units that can be combined and assembled into your own custom console arrangements. All doors and shelves come in glass or solid stainless steel. Drawers are all stainless steel. The shelving and desk cabinet dimensions are 24 1/8" x 60" x 18" and the warming cabinet dimensions are 30" x 60" x 20".

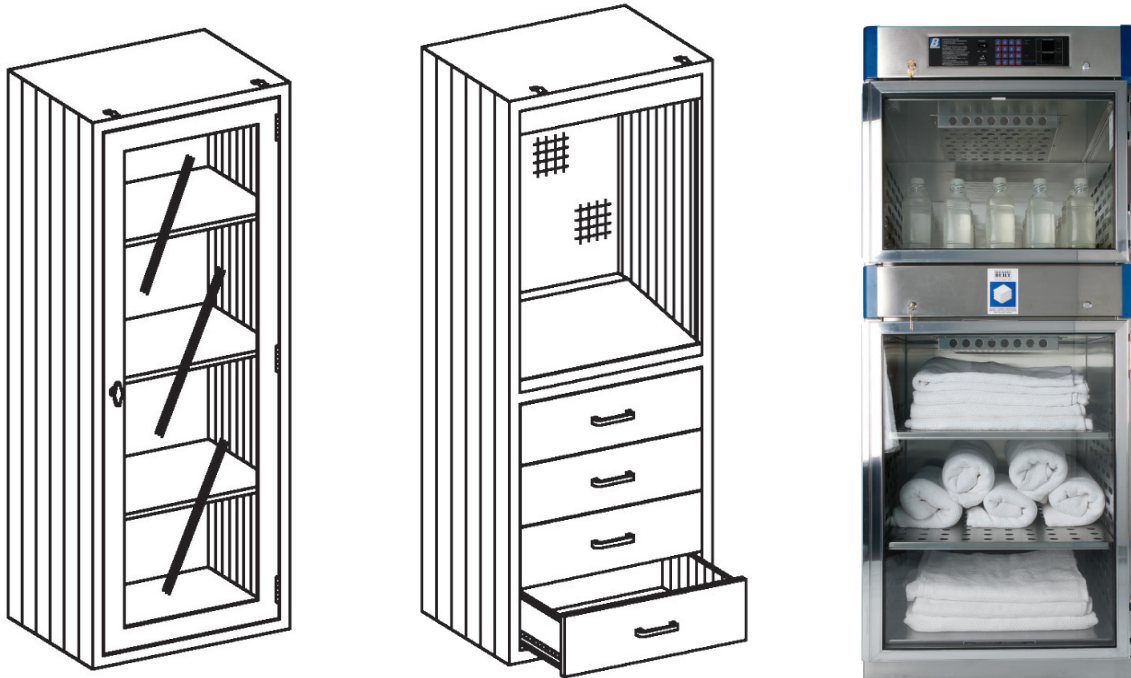

Name	Shelving Cabinet		Desk Cabinet	Warming Cabinet	
	Glass Door	Solid Door	Drawers	Glass Door	Solid Door
Model #	MS24	MS24S	DC24	SW30TG	SW30TS
Item #	1716724000	1716724258	1713224000	14BSW30243	14BSW30200
Shipping Weight	240 lbs.	240 lbs.	245 lbs.	320 lbs.	320 lbs.

Custom Designs Available Upon Request
Please email us at info@blickman.com

Cabinets

Console Cabinets

DOUBLE WIDTH

Description: Our double width console cabinets are all designed as individual units that can be combined and assembled into your own custom console arrangements. All doors and shelves come in glass or solid stainless steel. They are both 60" high and 18" deep and come in two width sizes: 35" and 47".



Name	Double Door Shelving Cabinet (Recessed Paul Cabinet)		Double Door Pegboard Cabinet (Recessed Walter Cabinet)	
	Glass Door	Solid Door	Glass Door	Solid Door
35" W				
Model #	ES35	ES35S	TA35G	TA35
Item #	1713735000	1713735258	1718235010	1718235000
Shipping Weight	250 lbs.	250 lbs.	250 lbs.	250 lbs.
47" W				
Model #	ES47	ES47S	TA47G	TA47
Item #	1713747000	1713747258	1718247003	1718247000
Shipping Weight	275 lbs.	275 lbs.	355 lbs.	355 lbs.

Custom Designs Available Upon Request
Please email us at info@blickman.com

Cabinets

CONSOLE CABINET
Accessories &
Options

ACCESSORIES

Cemented
Corner Guard,
16 gauge 304
stainless steel



Recess trim
available for
built-in console
cabinets

Model #	Description	Shipping Weight
CG4448	48" High corner guards, for protection and corrosion resistance (4"x4"x48")	20 lbs.
CG4496	96" High Corner guards, for protection and corrosion resistance (4"x4"x96")	20 lbs.
Rt120	Recessing trim, 22GA 304 stainless steel (10' strips, 1 1/2" x 1 1/2" wide)	20 lbs.



Electronic Locking Systems available
for most of our cabinets



Passthrough Cabinets available
for built-in applications

Custom Designs Available Upon Request
Please email us at info@blickman.com

Cabinets

CONSOLE CABINET
Construction
Specifications

Construction Specifications

Standard Dimensions	All console cabinets are 16" high x 18" deep, widths vary Exception: warming cabinets are 20" deep
Materials	304 Stainless Steel 1/4" clear tempered sheet glass
Gauge	Body, Sloped Top, Drawers, and Shelf Inserts: 18GA Glass Doors: Front and Back: 18GA Solid Doors (Front): 18GA; Solid Doors (Back): 20GA
Welding	All welding by heliarc method and exposed welds are ground smooth
Finish	Exposed surfaces are free from pit marks, weld seams, scale and are polished with #4 polish to a satin finish
Casters	N/A
Notes	<ul style="list-style-type: none">• All Console Cabinets: Solid doors are double panned, channel reinforced. Glass doors come in double shell design, with one piece outer frames dieformed to receive rubber gasketed glass panels held in place by inner retaining strips.• Double Door Console Cabinets: Right door fitted with two point up and down knob latching, left hand door with integral stops, dummy knob, and spring loaded nylon roller catch. Doors operate on three semi-concealed stainless steel hinges. Pegboard Cabinet interiors (back and sides) are lined with removable 18GA stainless steel pegboard.• Desk Console Cabinet: Four drawers with double wall fronts operate on side mounted, two section ball bearing roller slides with built-in extension stops. Heads provided with diecast aluminum bar pulls.• Single Door Shelving Console Cabinet: Can be either right or left hinged.• Recessed Warming Cabinet: Temperature control from 90°F - 160°F. 160x180 pixel graphical display with dual colors (red/green). Built-in temperature data recorder with real time clock (RTC).

Shipping Information

All shipping weights are estimates and may be changed without prior notice. Specifications may be improved and dimensions changed without prior notice. Please contact customer service for estimated shipping costs at info@blickman.com.

Blickman REVIT® Library

We have developed a library of our standard products using 3D Design Software REVIT®, which is available to your company at no charge.

Included in our Revit Library you can find:

Free standing Cabinets

Casework

Case Carts

Tables

Warming Cabinets

Visit: www.blickman.com/revit-files



Create your entire room from our cabinet files to discover a design that works best for your needs. We are happy to work with you to create custom cabinetry, casework, tables, etc. to fit in your space.

Custom Designs Available Upon Request

Please email us at info@blickman.com

BLICKMAN

BLICKMAN

OUR PROMISE

For over 100 years, Blickman has been known throughout the healthcare industry for exceptional product quality. We pride ourselves on providing high-end and personalized service to ensure 100% customer satisfied. If you are not completely satisfied for any reason, we will make it right. All of our equipment is backed by our Limited Lifetime Warranty, so you can be certain that you have made the very best choice for your healthcare facility.

Call Blickman:
Toll Free: (800) 247-5070
Local: (973) 330-0557

www.blickman.com
info@blickman.com
500 U.S. Highway 46 East, Clifton, NJ 07011