



# Digital Clinical Scale

## Owner's Manual



**Model apex-sh**  
With Sonar Height Rod



**Model apex**  
With Inline Height Rod



# INTRODUCTION

Thank you for purchasing our Detecto apex® Digital Clinical Scale. It has been manufactured with quality and reliability and has been tested before leaving our factory to ensure accuracy and dependability for years to come.

This manual is provided to guide you through installation and operation of your scale. Please read it thoroughly before attempting to install or operate your scale and keep it handy for future reference.

This manual is for use with all apex® model configurations.

APEX	APEX-SH	APEX-SH-WI-ACM(ACMUK)
APEX-AC(ACUK)	APEX-SH-AC(ACUK)	APEX-SH-S2E1-ACM(ACMUK)
APEX-LXI-AC(ACUK)	APEX-SH-LXI-AC(ACUK)	
APEX-WI-AC(ACUK)	APEX-SH-WI-AC(ACUK)	
APEX-UWA-AC(ACUK)	APEX-SH-UWA-AC(ACUK)	

## COPYRIGHT

All rights reserved. Reproduction or use, without expressed written permission, of editorial or pictorial content, in any manner, is prohibited. No patent liability is assumed with respect to the use of the information contained herein.

## DISCLAIMER



While every precaution has been taken in the preparation of this manual, the Seller assumes no responsibility for errors or omissions. Neither is any liability assumed for damages resulting from use of the information contained herein. All instructions and diagrams have been checked for accuracy and ease of application; however, success and safety in working with tools depend largely upon the individual accuracy, skill, and caution. For this reason, the Seller is not able to guarantee the result of any procedure contained herein. Nor can they assume responsibility for any damage to property or injury to persons occasioned from the procedures. Persons engaging in the procedures do so entirely at their own risk.

## FCC COMPLIANCE STATEMENT

This equipment generates, uses and can radiate radio frequency, and if not installed and used in accordance with the instruction manual, may cause interference to radio communications. It has been designed within the limits for a Class A computing device pursuant to Subpart J of Part 15 of FCC rules to provide reasonable protection against such interference when operated in a commercial environment. Operation of this equipment in a residential area may cause interference in which case the user will be responsible to take whatever measures necessary to correct the interference.

You may find the booklet "How to Identify and Resolve Radio TV Interference Problems" prepared by the Federal Communications Commission helpful. It is available from the U.S. Government Printing Office, Washington, D.C. 20402. Request stock No. 001-000-00315-4.

<b>Serial Number</b> _____ <b>Date of Purchase</b> _____ <b>Purchased From</b> _____ _____ _____ _____ _____ <small>RETAIN THIS INFORMATION FOR FUTURE USE</small>
---

<b>PRECAUTIONS</b>	
Before using this scale, read this manual and pay special attention to all "NOTIFICATION" symbols:	
 IMPORTANT	 ELECTRICAL WARNING

## PROPER DISPOSAL

When this device reaches the end of its useful life, it must be properly disposed of. It must not be disposed of as unsorted municipal waste. Within the European Union, this device should be returned to the distributor from where it was purchased for proper disposal. This is in accordance with EU Directive 2002/96/EC. Within North America, the device should be disposed of in accordance with the local laws regarding the disposal of waste electrical and electronic equipment.

It is everyone's responsibility to help maintain the environment and to reduce the effects of hazardous substances contained in electrical and electronic equipment on human health. Please do your part by making certain that this device is properly disposed of. The symbol shown to the right indicates that this device must not be disposed of in unsorted municipal waste programs.



## CAUTION



**CAUTION:** RISK OF EXPLOSION IF BATTERY IS REPLACED BY AN INCORRECT TYPE. DISPOSE OF USED BATTERIES ACCORDING TO THE INSTRUCTIONS.

**ATTENTION:** RISQUE D'EXPLOSION SI LA BATTERIES EST REMPLAC'E PAR UN TYPE INCORRECT. REJETEZ LES BATTERIES UTILISE'ES SELON LES INSTRUCTIONS.

## TRANSPORTATION AND STORAGE



**Do Not Drop**

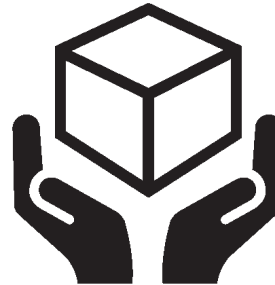

**Handle With Care**



**Keep Dry**

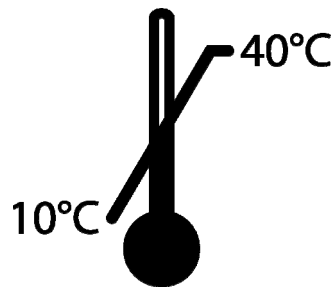

**Temperature Range**

# TABLE OF CONTENTS

<b>SPECIFICATIONS</b> .....	<b>Page 1</b>
Standard Features .....	Page 1
Optional Features .....	Page 1
<b>SITE PREPARATION REQUIREMENTS</b> .....	<b>Page 2</b>
<b>UNPACKING</b> .....	<b>Page 3</b>
<b>APEX (with mechanical height rod) ASSEMBLY</b> .....	<b>Page 3</b>
<b>APEX (with mechanical height rod) UNIT SELECTION</b> .....	<b>Page 5</b>
<b>APEX-SH (with sonar height rod) ASSEMBLY</b> .....	<b>Page 6</b>
<b>APEX (with sonar height rod) UNIT SELECTION</b> .....	<b>Page 8</b>
<b>INTERCONNECTIONS</b> .....	<b>Page 9</b>
AC Power Adapter (in included) .....	Page 9
USB .....	Page 9
<b>PLACING THE SCALE</b> .....	<b>Page 9</b>
<b>BATTERIES</b> .....	<b>Page 10</b>
Battery Status .....	Page 10
Battery Installation/Replacement .....	Page 11
<b>BATTERY SAVER FEATURE</b> .....	<b>Page 11</b>
<b>KEYPAD FUNCTIONS</b> .....	<b>Page 13</b>
<b>ANNUNCIATORS</b> .....	<b>Page 15</b>
<b>APEX (with mechanical height rod) OPERATION</b> .....	<b>Page 16</b>
Zero Weight Display .....	Page 16
Basic Operation .....	Page 16
Body Mass Index (BMI) Operation .....	Page 16
<b>INLINE HEIGHT ROD OPERATION</b> .....	<b>Page 17</b>
<b>APEX-SH (with sonar height rod) OPERATION</b> .....	<b>Page 18</b>
Zero Weight Display .....	Page 18
Basic Operation .....	Page 18
Body Mass Index (BMI) Operation, Using Sonar Height .....	Page 18
Body Mass Index (BMI) Operation, Manually Entering Known Height .....	Page 19
<b>SCALE SETUP</b> .....	<b>Page 21</b>
<b>DATA FORMATS</b> .....	<b>Page 28</b>
<b>EVENT COUNTER</b> .....	<b>Page 29</b>
<b>ERROR AND OPERATION MESSAGES</b> .....	<b>Page 30</b>
<b>BEFORE YOU CALL SERVICE</b> .....	<b>Page 30</b>
<b>CARE AND CLEANING</b> .....	<b>Page 31</b>
<b>PARTS IDENTIFICATION</b> .....	<b>Page 32</b>
APEX (with mechanical height rod) .....	Page 32
APEX-SH (with sonar height rod) .....	Page 34
Display Sub-Assembly .....	Page 37
Base Sub-Assembly .....	Page 38



## SPECIFICATIONS

Models:	<b>apex® (with mechanical height rod)</b>	<b>apex®-sh (with sonar height rod)</b>
Height Rod Type:	Inline Height Rod	Sonar Height Rod
Height Rod Measures:	24" (2') – 86" (7'2") x 0.125 in (60 cm – 218 cm) x 0.1 cm	24" (2') – 86" (7'2") x 0.2 in (60 cm – 218 cm) x 0.5 cm
Capacity:	600 lb x 0.2 lb (300 kg x 0.1 kg)	
Weighing/Height Units:	Pounds/Inch (lb, in) or Kilograms/Centimeters (kg, cm)	
Platform Size:	17 in W x 17 in D x 2.75 in H (43 cm W x 43 cm D x 7 cm H)	
apex® Overall Dimensions:	17 in W x 19.5 in D x 53.3 in H (43 cm W x 49.5 cm D x 135.3 cm H)	
apex®-sh Overall Dimensions:	17 in W x 19.5 in D x 89.5 in H (43 cm W x 49.5 cm D x 227.3 cm H)	
Display Type:	Dual Row Seven Segment LCD	
Number of Characters:	Weight: 5 digits, 0.75 in (19 mm) high Height/BMI: 4 digits, 0.4 in (10 mm) high	
Keys:	Mechanical switch type, Power, Lock/Release, Zero, Up Arrow, Down Arrow/Send, BMI/Enter	
Power Requirements:	12 "AA" cell Alkaline, Ni-Cad or NiMH batteries ( <i>not included</i> ) or <i>optional</i> 100 to 240 VAC 50/60Hz 12 VDC 1 A wall plug-in UL/CSA listed AC power adapter (Cardinal part number 6800-1045)	
Operating Environment:	Operated Temperature Range: 14 to 104 °F (-10 to +40 °C) Humidity: 0 to 90% non-condensing	
Communication Interfaces:	USB	

### Standard Features:

- Power-Up Zero
- Auto Weight Lock Feature
- StableSENSE®<sup>1</sup> Adjustable Filtering
- 1 Micro-B USB Port
- Sonar Height Rod (Model apex®-sh)

### Optional Features:

- Wi-Fi
- Bluetooth
- WACONNECT, Welch Allyn® Interface
- Optional 12 VDC AC Power Adapter

<sup>1</sup> StableSENSE® is a digital filter utilizing proprietary software algorithms to remove or greatly reduce changes in the weight display resulting from movement on the scale platform. StableSENSE® can be used with clinical scales to lessen the effects of the patient's movement or vibration on the scale. Any application affected by vibration or movement on the scale platform can benefit using StableSENSE®.

# SITE PREPARATION REQUIREMENTS

The apex® Digital Clinical Scale is a precision weight indicating instrument. As with any precision instrument, it requires an acceptable environment to operate at peak performance and reliability. This section is provided to assist you in obtaining such an environment.

## Environmental

- For indoor use only.
- Suitable for dry environments only RH < 90% and non-condensing environments.
- NEVER allow scale to get wet.
- The scale meets or exceeds all certification requirements within a temperature range of 14 to 104 °F (-10 to +40 °C).

The scale should be placed out of direct sunlight and to provide adequate air circulation, keep the area around the scale clear.

Do not place the scale directly in front of a heating or cooling vent. Such a location will subject it to sudden temperature changes, which may result in unstable weight readings.

Ensure that the scale has good, clean AC power and is properly grounded. In areas subject to lightning strikes, additional protection to minimize lightning damage, such as surge suppressors, should be installed.

## Electrical Power

The apex® Digital Clinical Scale has been designed to operate from a 100 to 240 VAC 50/60Hz 12 VDC 1 A wall plug-in UL/CSA listed AC power adapter. Note that a special order is not required for operation at 230 VAC.

- The socket-outlet supplying power to the scale should be near the scale and should be easily accessible.
- On installations requiring 230 VAC power, **it is the responsibility of the customer** to have a qualified electrician install the proper power adapter plug that conforms to national electrical codes and local codes and ordinances.

## Electrical Noise Interference

To prevent electrical noise interference, make certain all air conditioning and heating equipment, lighting or other equipment with heavily inductive loads, such as welders, motors and solenoids are on circuits separate from the system. Many of these disturbances can seriously affect the operation of the system. These sources of disturbances must be identified and steps must be taken to prevent possible adverse effects on the system. Examples of available alternatives include isolation transformers, power regulators, uninterruptible power supplies, or simple line filters.



## UNPACKING

Carefully remove the apex® Digital Clinical Scale from the shipping carton and inspect it for any damage that may have taken place during shipment. *Keep and use the original carton and packing material for return shipment if it should become necessary.* The purchaser is responsible for filing all claims for any damages or loss incurred during transit. Remove all plastic wrapping, foam fillers and cardboard material from scale platform, display and other components. You should have the following components:

### apex® (with mechanical height rod)

- ① Column with attached Display
- ② Scale Base
- ③ Scale Base Cover
- ④ Optional AC Power Adapter

### apex®-sh (with sonar height rod)

- ① Column with attached Display and Sonar Bracket
- ② Column Cover
- ③ Scale Base
- ④ Scale Base Cover
- ⑤ Sonar Height Rod
- ⑥ Optional AC Power Adapter

## APEX (with mechanical height rod) ASSEMBLY

### TOOLS REQUIRED:

3/16" Allen wrench

1. Place the scale base on a level floor.
2. Locate the scale base cable and pull it out of the base and under the wheel's axle.
3. Install the column cover onto the column.



Step 1

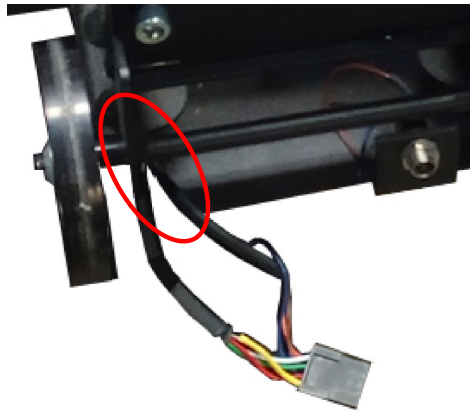

Step 2



Step 3

4. Position the column over the opening in the scale base and then insert the column into the scale base making sure the cable from the column goes out of the scale base and under the axle for the wheels.
5. With both cable coming out of the scale base under the axle, align the wire connector from the column cable with the wire connector from the scale base cable and then plug them together.

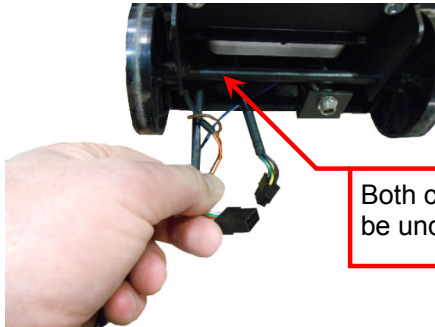

Step 4

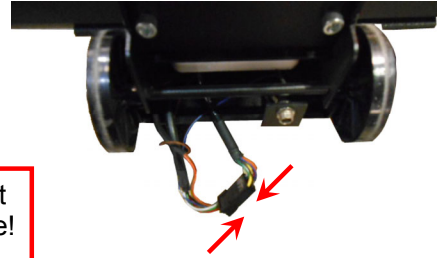

Step 5

Both cables must be under the axle!

6. Making sure the column is completely down in the scale base and against the back plate, tuck the connected cables into the scale base under the axle.



Step 6

7. Using the 3/16" Allen wrench, *evenly* tighten the (4) Allen head screws on the back of the scale base to secure column to scale base.



**NOTE:** The nuts on the front of the column opening in the scale base may turn as you are tightening the Allen head screws.

*This is normal.* DO NOT use a wrench or other tool to hold the nut to keep it from turning!

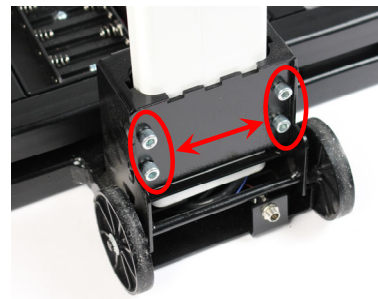

Step 7

8. Slide the column cover down onto the base. Note that you may have to pull the cover out slightly to clear the AC power jack.
9. Place the scale base cover on the scale base and press down on both sides of the cover. Note that a clicking sound will occur when the cover is snapped in place.

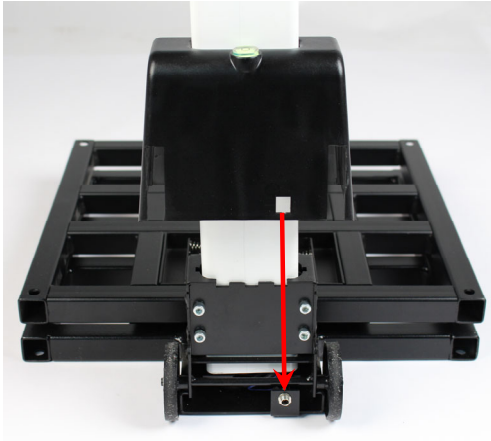

Step 8

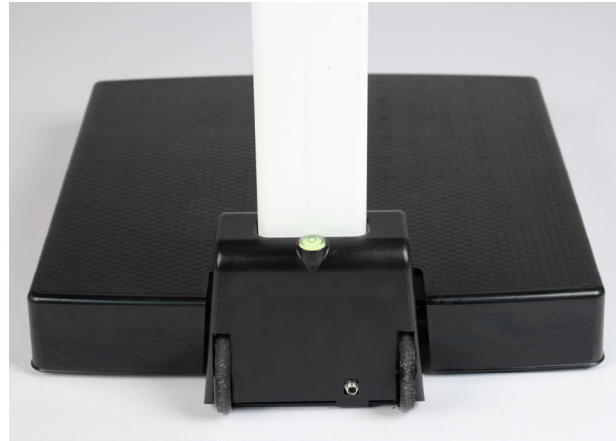

Step 9







10. The scale is now ready for operation.



**NOTE:** For instructions on powering the scale using the AC power adapter (if included) or for instructions on how to install batteries, refer to the INTERCONNECTIONS section of this manual.

## APEX (with mechanical height rod) UNIT SELECTION

When the apex® (with mechanical height rod) scale is powered on for the *first* time, all digits on the display will turn on and then change to show the software version for a few seconds and finally prompt for which weighing unit to use, **lb** or **kg**.

1. The display will show *SEL Unit* with the lb annunciator, the current unit setting turned on. If the setting displayed is acceptable, press the  key to save it. Otherwise, press the  or  keys to toggle the weighing units between lb (pounds) or kg (kilograms) and then press the  key to save it.
2. The display will change to show *0.0*, with the 0< (ZERO), the ▲ (STABLE) and the unit selected turned on.
3. The scale is now ready for operation.
4. Once the unit setting is selected, it will be kept.



**NOTE:** If it is desired to change the unit setting, refer to the SCALE SETUP section, *Unit* (WEIGHING UNITS) prompt.

# APEX-SH (with sonar height rod) ASSEMBLY

## TOOLS REQUIRED:

3/16" Allen wrench

1. Place the scale base on a level floor.
2. Locate the scale base cable and pull it out of the base and under the wheel's axle.
3. Install the column cover onto the column.



Step 1

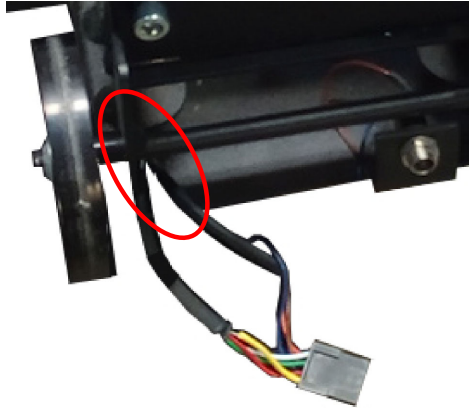

Step 2



Step 3

4. Position the column over the opening in the scale base and then insert the column into the scale base making sure the cable from the column goes out of the scale base and under the axle for the wheels.
5. With both cables coming out of the scale base under the axle, align the wire connector from the column cable with the wire connector from the scale base cable and then plug them together.

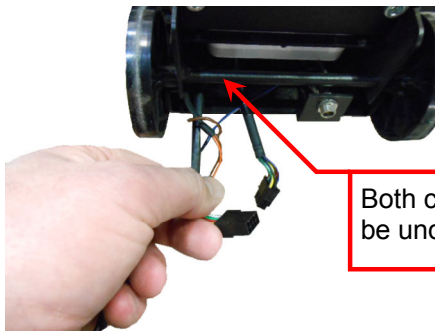

Step 4

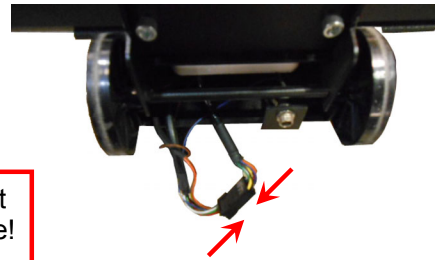

Step 5

Both cables must be under the axle!

6. Making sure the column is completely down in the scale base and against the back plate, tuck the connected cables into the scale base under the axle.

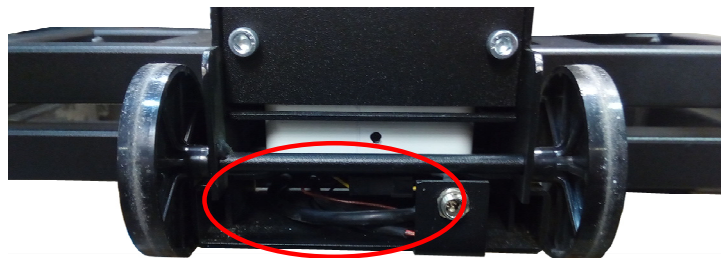

Step 6

7. Using the 3/16" Allen wrench, *evenly* tighten the (4) Allen head screws on the back of the scale base to secure column to scale base.



**NOTE:** The nuts on the front of the column opening in the scale base may turn as you are tightening the Allen head screws.

*This is normal.* DO NOT use a wrench or other tool to hold the nut to keep it from turning!



Step 7

8. Slide the column cover down onto the base. Note that you may have to pull the cover out slightly to clear the AC power jack.
9. Place the scale base cover on the scale base and press down on both sides of the cover. Note that a clicking sound will occur when the cover is snapped in place.

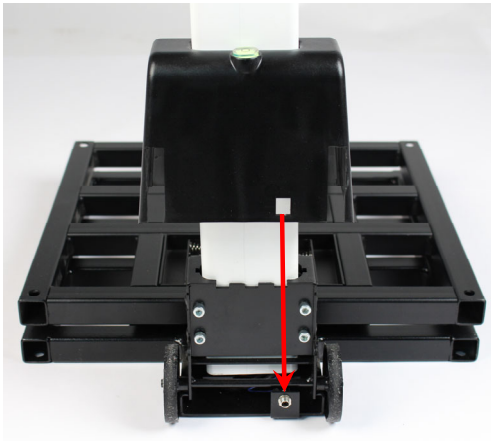

Step 8



Step 9

10. Remove the sonar bracket by pushing up from the bottom of the bracket (see Step 10a) until the screws are aligned with the large end of the slotted holes (see Step 10b) in the bracket and pull it away from the column. Set the sonar bracket aside.
11. Align the wire connector from the end of Sonar tube with the wire connector from the back of column and plug together.



Step 10a



Step 10b



Step 11



12. Place the bracket over the sonar tube making sure the tube is completely down in the bracket.
13. Next, insert the cable and connector into the hole on the back of the column.
14. Aligning the large end of the slotted holes in the bracket with the screws in the column, (see Step 12 and Step 13) place the sonar tube on the back of the column and pull down to secure the sonar bracket to the column.



Step 12 and Step 13

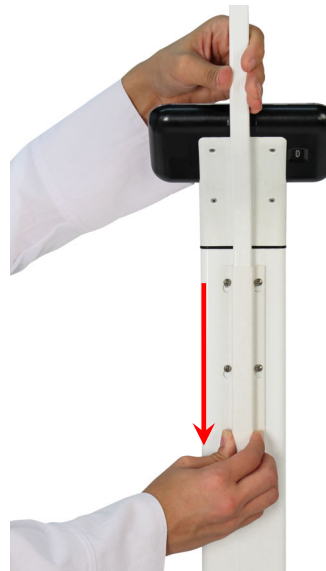

Step 14

15. The scale is now ready for operation.



**NOTE:** For instructions on powering the scale using the AC power adapter (if included) or for instructions on how to install batteries, refer to the INTERCONNECTIONS section of this manual.

## APEX-SH (with sonar height rod) UNIT SELECTION

When the apex®-sh (with sonar height rod) scale is powered on for the *first* time, all digits change to show the software version for a few seconds and finally prompt for which weighing unit to use, **lb** or **kg**.

1. The display will show *SEL Unit* with the lb annunciator, the current unit setting turned on. If the setting displayed is acceptable, press the **←** key to save it. Otherwise, press the **↑** or **↓** keys to toggle the weighing units between lb (pounds) or kg (kilograms) and then press the **←** key to save it.
2. The display will change to show *0.0*, with the **→0←** (ZERO), the **▲▲** (STABLE) and the unit selected turned on.
3. The scale is now ready for operation.
4. Once the unit setting is selected, it will be kept.



**NOTE:** If it is desired to change the unit setting, refer to the SCALE SETUP section, *Unit* (WEIGHING UNITS) prompt.

## INTERCONNECTIONS

The input and output connections to the scale are made on the back of the display. The AC Power Adapter (if included) connection to the scale is located on the back of the scale base.

### AC Power Adapter (if included)

To power the scale using the 12 VDC wall plug-in UL/CSA listed AC power adapter (if included), connect the plug from the adapter into the power jack on the back of the scale base, then plug the power adapter into the proper electrical outlet. On models requiring 230 VAC, it is the customer's responsibility to obtain a correct power adapter plug.

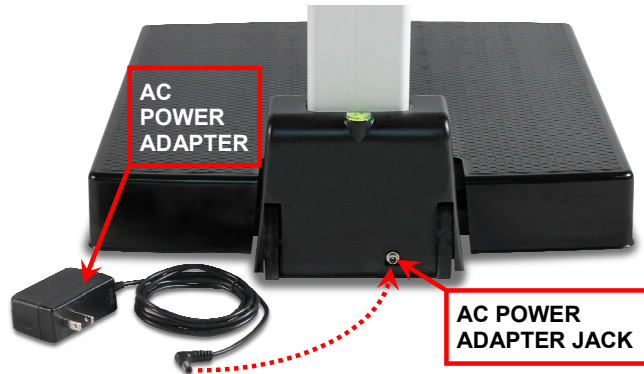

### USB

The USB port on the scale is a device (or upstream) port and uses readily available cables with the industry standard "Micro-B" connector.

The USB port may be connected to a computer for transmission of weight and associated data to a PC-based EMR (electronic medical record) software program. The data can be transmitted on demand (pressing the  key) or on receipt of a command from the computer.

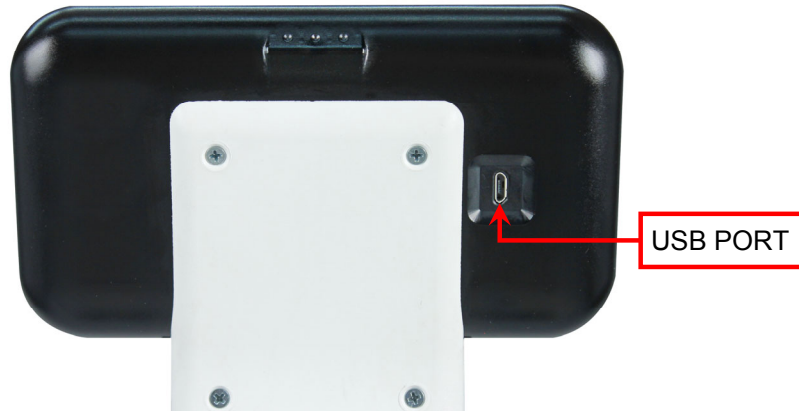

## PLACING THE SCALE

- For indoor use only.
- Place scale on a flat, level floor or low-cut carpet away from heating and cooling vents.
- Make certain the AC Power Adapter (if included) cord is out of the way of normal traffic to avoid a trip hazard.
- NEVER allow scale to get wet.

Check to make certain the scale is level. The level indicator is located at the rear of the scale. If the scale is not level (the bubble will not be centered), position the scale as required to center the bubble and attain a level scale.

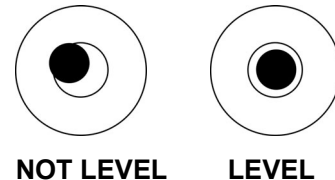

**NOTE:** Any time the scale is moved or re-located, be sure to check the level bubble to ensure the scale is level before using.

## BATTERIES

The scale can use twelve "AA" size Alkaline, Ni-Cad, or NiMH batteries (*not included*). You must first obtain and install batteries before operations can begin. Batteries are contained in two battery holders (six batteries in *each* holder) inside the scale base. Remove the scale platform cover to access the battery holders in the scale base.



**CAUTION!** The scale can be operated from Alkaline, Ni-Cad or NiMH batteries. All twelve batteries must be of the same type. They must all be Alkaline, all Ni-Cad, or all NiMH. **DO NOT** mix Alkaline and Ni-Cad or NiMH batteries.



**NOTE:** The apex® scale *does not* have a battery charging circuit. Should you wish to use Ni-Cad or NiMH batteries, they must be *fully* charged before installing. When discharged, Ni-Cad or NiMH batteries must be removed and placed in an external charger to recharge.

### Battery Status

The battery status will be displayed when batteries are installed. The battery bar graph on the display indicates the battery capacity in five steps:

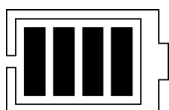

- 4 segments - the full battery capacity is available,
- 3 segments - the battery is at 80% of capacity,
- 2 segments - the battery is at 60% of capacity,
- 1 segment: - the battery is at 40% capacity.
- 0 segments - the battery is at less than 20% capacity

When the battery voltage drops too low for accurate weighing, the scale display will show  $L \square$  on the small upper seven-segment display and  $bAtt$  on the large lower seven-segment display and shut off. You will be unable to turn the scale back on until the batteries have been replaced.

### Using Alkaline Batteries

When no bars are shown on the battery status symbol, press the  key to turn the scale off, remove the old batteries and replace with new ones.

### Using NiCad or NiMH Batteries

When no bars are shown on the battery status symbol, press the  key to turn the scale off, remove the discharged batteries and replace with fully charged ones. Place the discharged batteries in an external charger to recharge.



## Battery Installation/Replacement

To install or remove the batteries, the following steps should be followed:

1. Remove the platform cover from the scale base.
2. Referring to Figure No. 1, locate the two battery holders in the scale base.
3. If installing new batteries, proceed to step 4. If replacing the batteries, remove all twelve batteries (six in each holder) from the battery holders, and then proceed to step 4.
4. Referring to Figure No. 2, install the new twelve "AA" size batteries (six in each holder), noting the polarity markings located in the battery holders.
5. After placing all twelve batteries (six in each holder), install the platform cover on the scale base and press the  key.



Figure No. 1

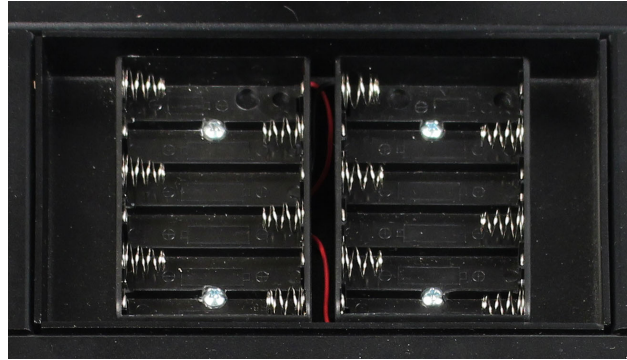



Figure No. 2

6. If display turns on, batteries have been installed correctly. If not, remove the platform cover and check for one or more improperly positioned batteries.
7. The scale is now ready for operation.

## BATTERY SAVER FEATURE

This scale is equipped with a battery saver feature that helps prolong battery life by dimming the scale display backlight and turning the scale off when not in use.

### Using Batteries

When using batteries, after one minute of inactivity (no motion on scale and no keys pressed) the scale will automatically turn off. To turn the scale back on you must press the  key. The backlight on the scale display will be at 50% brilliance to conserve battery life.

### Using AC Power Adapter (if included)

When using the AC power adapter (if included), the automatic shut-off feature is *disabled* and the scale will remain on regardless of the length of time of inactivity. In addition, the backlight on the scale display will be at full brilliance.



## KEYPAD FUNCTIONS

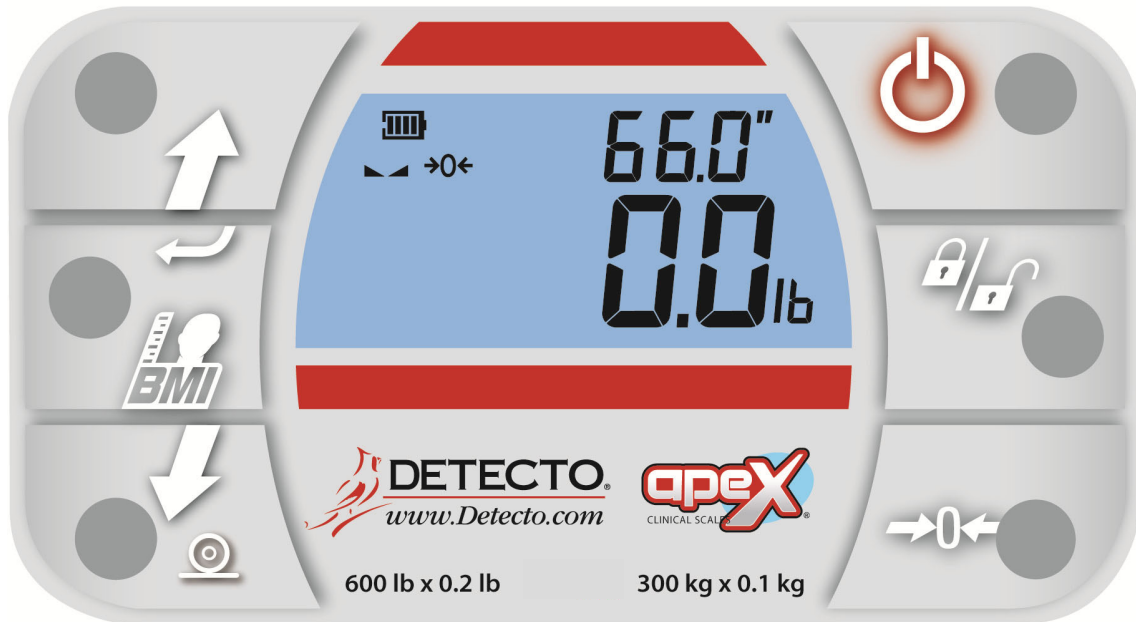

**DO NOT** operate the keys with pointed objects (pencils, pens, etc.). Damage to keys resulting from this practice is **NOT** covered under warranty.



This is the **Power** key. With the scale off, pressing this key will apply power to the scale and turn on the display. If the scale is already on, pressing the key will turn it off.





This is the **Lock/Release** key. Press and release this key to cause the weight, height, and BMI to lock on the current values until the key is pressed again. While the scale display is locked, the annunciator resembling a padlock  will turn on in order to denote that the weight is being held.





This is the **Zero** key. Press and release this key to reset the display to zero. Note that when this key is pressed with weight on the scale platform, the display will zero the weight up to 100% of the scale capacity. When the weight is removed, the display will show a negative weight value. Press the  key again to reset the display to zero.



This is the **Enter** key. It serves two purposes. First, during setup, pressing the  key will accept the current displayed setting of the parameter. Second, the  key is used to signal completion of the entry of data (in both setup and operation) and causes the scale to process the data entered.



This is the **BMI** key. It is used to input the patient's height and then to perform the Body Mass Index (BMI) calculation. Note that the scale will not respond to pressing the key unless the weight is stable.

Pressing the key once allows the operator to enter the height of the patient using the  or  keys to increase or decrease to the correct height. After entering the patient's height, pressing it again will display the Body Mass Index (BMI) calculation. Pressing it a third time, will return the display to the patient's weight.



### (Up Arrow Key)

During operation, the  $\uparrow$  key is used when performing the Body Mass Index (BMI) calculation to increase the height value.

**NOTE:** When entering the height for BMI calculation, pressing and holding the up arrow key  $\uparrow$  key allows you to rapidly increase the height entry.



### (Down Arrow)

During operation, the  $\downarrow$  key is used when performing the Body Mass Index (BMI) calculation to decrease the height value.

**NOTE:** When entering the height for BMI calculation, pressing and holding the up arrow key  $\downarrow$  key allows you to rapidly decrease the height entry.



This key is used to signal completion of the data entry, process the data entered and to send the weight and associated data to the USB port.

**NOTE:** The scale will not respond to pressing the  $\odot$  key unless the weight display is stable.



### (Arrow Keys)

During setup and calibration, the  $\uparrow$  or  $\downarrow$  keys are used when selecting setup values. Pressing will increase or decrease the value of the selected parameter or toggle between the available parameter values. Pressing the  $\leftarrow$  key will save the value selected and advance to the next parameter.

Each press of the arrow keys will increase or decrease the displayed setup parameter value by one-step.

**NOTE:** When entering the scale capacity ( $\zeta RP$ ) and calibration load value ( $LORd$ ) pressing and holding the arrow keys allow you too rapidly, increase, or decrease the displayed setup parameter value.

# ANNUNCIATORS

The annunciators are displayed on the Weight screen to show that the scale is in the mode corresponding to the annunciator label or that the status indicated by the label is active.

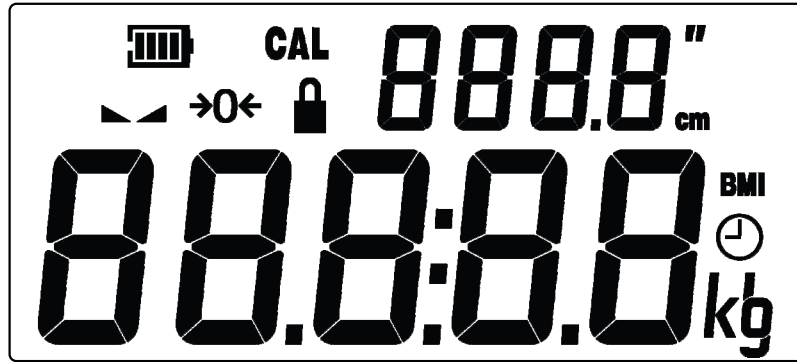

The low battery annunciator is located in the upper left corner of the display. It is used to indicate the battery status. Refer to Battery section of this manual for more details.

## **CAL (Calibration)**

This annunciator is turned on when scale is in the Setup and Calibration mode.

## **▲▲ (STABLE)**

This annunciator is turned on when the weight display is stable. When off, it means that the change in successive weight samples are greater than the motion limits selected during setup.

## **→0← (ZERO)**

This annunciator is turned on to indicate that the weight displayed is within +/- 1/4 division of the center of zero.

## **🔒 LOCK**

This annunciator is turned on to show that the indicator is locked onto the displayed weight. In operation, after obtaining a stable weight, pressing the  key will cause the scale display to lock onto the weight and turn on the annunciator. Pressing the key again will unlock the display and turn off the annunciator.

## **BMI (Body Mass Index)**

This annunciator is turned on when displaying the calculated body fat.

## **kg**

This annunciator is turned on to indicate that the displayed weight is in kilograms.

## **lb**

This annunciator is turned on to indicate that the displayed weight is in pounds.

## **cm**

This annunciator is turned on when the displayed height measurement is in centimeters.

## **''**

This annunciator is turned on when the displayed height measurement is in inches.

# APEX (with mechanical height rod) OPERATION



**ALWAYS** assist the patient in stepping on and off the scale platform to ensure they do not fall. **NEVER** leave a patient unattended while they are on the scale platform. Failure to maintain control of the patient at all times can result in serious injury to you and/or the patient.

## Zero Weight Display

1. If the scale is not showing zero weight on the display, press  $\Rightarrow 0 \Leftarrow$  key.
2. The Weight display will return to zero. The  $\rightarrow 0 \leftarrow$  (ZERO) and  $\blacktriangle \blacktriangle$  (STABLE) annunciators will turn on to show a stable, center-of-zero weight condition.

## Basic Operation

### To Weigh

1. Press  $\text{Power}$  key to turn scale on.
2. If required, press  $\Rightarrow 0 \Leftarrow$  key to zero weight display.
3. Assist patient onto scale
4. When weight is stable, the  $\blacktriangle \blacktriangle$  (STABLE) annunciator will turn on.
5. The weight reading will automatically lock and the annunciator resembling a padlock  $\text{Lock}$  will turn on. Note that the amount of time the reading will hold is dependent upon the *HOLD* setting in Setup. **NOTE:** If more time is needed, press the  $\text{Lock}$  key to hold the locked weight reading.
6. Read and record weight displayed.
7. Assist patient off scale.

## Body Mass Index (BMI) Operation

### Using Inline Height Rod

1. Press  $\text{Power}$  key to turn scale on.
2. If required, press  $\Rightarrow 0 \Leftarrow$  key to zero weight display.
3. Assist patient onto scale.
4. When weight is stable, the  $\blacktriangle \blacktriangle$  (STABLE) annunciator will turn.
5. The weight reading will automatically lock and the annunciator resembling a padlock  $\text{Lock}$  will turn on. Note that the amount of time the reading will hold is dependent upon the *HOLD* setting in Setup. **NOTE:** If more time is needed, press the  $\text{Lock}$  key to hold the locked weight reading.
6. Read and record weight displayed.
7. Press  $\uparrow$  or  $\downarrow$  keys to increment or decrement to the previously measured patient's height. See INLINE HEIGHT ROD OPERATION for instructions on measuring patient.
8. Press  $\text{BMI}$  key. Display will change to show BMI (Body Mass Index).
9. Read and record patient's BMI.  
**NOTE:** While patient is still standing on scale, pressing  $\text{BMI}$  key will toggle between BMI and weight display.
10. Assist patient off scale.
11. Once patient steps off scale, display automatically returns to weight only mode.

## INLINE HEIGHT ROD OPERATION

If the patient is 47" (120 cm) or taller:

1. Lift spoon on height rod to horizontal position.
2. Referring to the illustration to the right, raise spoon, and inner height rod well above estimated height of patient's head.
3. Assist patient onto scale.
4. While keeping spoon horizontal, carefully lower inner height rod (press down in same area as used to lift it) until spoon rests on top of patient's head.
5. Read height of patient at the black edge on the outer column.
6. Referring to the figure, lift spoon (while keeping it horizontal) and raise it above patient's head.
7. Assist patient off scale.
8. Lower spoon back to vertical position and return height rod to the "stored" position (spoon should be vertical against outer column and inner height rod should be flush with the top of column).

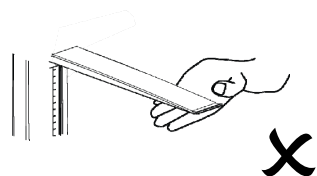
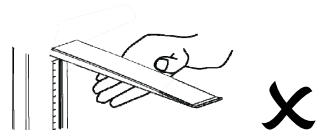

If the patient is shorter than 47" (120 cm):

1. Assist patient onto scale.
2. Make sure patient is looking straight ahead. Position patient's head so that a horizontal line from the ear canal to the lower border of the eye socket runs parallel to the floor.
3. Make sure measurer's eyes are at same level as patient's head.
4. Read height of patient on the outer column.
5. Assist patient off scale.

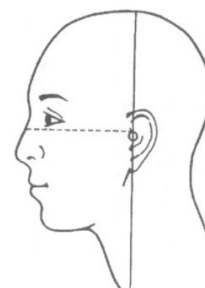

# APEX-SH (with sonar height rod) OPERATION



**ALWAYS** assist the patient in stepping on and off the scale platform to ensure they do not fall. **NEVER** leave a patient unattended while they are on the scale platform. Failure to maintain control of the patient at all times can result in serious injury to you and/or the patient.

## Zero Weight Display

1. If the scale is not showing zero weight on the display, press  $\Rightarrow 0 \Leftarrow$  key.
2. The Weight display will return to zero. The  $\rightarrow 0 \leftarrow$  (ZERO) and  $\blacktriangle \blacktriangle$  (STABLE) annunciators will turn on to show a stable, center-of-zero weight condition.

## Basic Operation

### To Weigh

1. Press  $\text{Power}$  key to turn scale on.
2. If required, press  $\Rightarrow 0 \Leftarrow$  key to zero weight display.
3. Assist patient onto scale
4. When weight is stable, the  $\blacktriangle \blacktriangle$  (STABLE) annunciator will turn on.
5. The weight reading will automatically lock and the annunciator resembling a padlock  $\text{Lock}$  will turn on. Note that the amount of time the reading will hold is dependent upon the *Hold* setting in Setup. **NOTE:** If more time is needed, press the  $\text{Hold}$  key to hold the locked weight reading.
6. Read and record weight displayed.
7. Assist patient off scale.

## Body Mass Index (BMI) Operation

### Using Sonar Height Rod

1. Press  $\text{Power}$  key to turn scale on.
2. If required, press  $\Rightarrow 0 \Leftarrow$  key to zero weight display.
3. Assist patient onto scale.









**NOTE:** In order to obtain an accurate height measurement, instruct patient to look straight ahead and not down at scale display.

4. When weight is stable, the  $\blacktriangle \blacktriangle$  (STABLE) annunciator will turn.
5. The weight reading will automatically lock and the annunciator resembling a padlock  $\text{Lock}$  will turn on. Note that the amount of time the reading will hold is dependent upon the *Hold* setting in Setup. **NOTE:** If more time is needed, press the  $\text{Hold}$  key to hold the locked weight reading.
6. Scale will have completed measuring patient's height and calculating their BMI.
7. Read and record weight displayed.
8. Press  $\text{BMI}$  key. Display will change to show BMI (Body Mass Index).
9. Read and record patient's BMI.  
**NOTE:** While patient is still standing on scale, pressing  $\text{BMI}$  key will toggle between BMI and weight display.
10. Assist patient off scale.
11. Once patient steps off scale, display automatically returns to weight only mode.



## Body Mass Index (BMI) Operation

### Manually Entering Known Height

1. Press  key to turn scale on.
2. If required, press  $\Rightarrow 0 \Leftarrow$  key to zero weight display.
3. Assist patient onto scale.
4. When weight is stable, the  (STABLE) annunciator will turn.
5. The weight reading will automatically lock and the annunciator resembling a padlock  will turn on. Note that the amount of time the reading will hold is dependent upon the *HOLD* setting in Setup. **NOTE:** If more time is needed, press the  key to hold the locked weight reading.
6. Read and record weight displayed.
7. If the  key was not pressed in Step 5, press it now to hold weight reading.
8. Press  or  keys to increment or decrement to known patient's height.
9. Press  key. Display will change to show BMI (Body Mass Index).
10. Read and record patient's BMI.  
**NOTE:** While patient is still standing on scale, pressing  key will toggle between BMI and weight display.
11. Assist patient off scale.
12. Once patient steps off scale, display automatically returns to weight only mode.



# SCALE SETUP

Your apex® Digital Clinical Scale has been pre-configured at the factory and should not require changes for use in most applications. However, if the factory settings do not meet the requirements of your operation, the following describes the setup process for your scale.



**NOTE: The keys are not to be operated with pointed objects (pencils, pens, fingernails, etc.). Damage to the keys resulting from this practice will NOT be covered under warranty.**

## To Enter Setup

1. Press the  key to turn the scale on.
2. The scale will perform a display test (turn on all segments and annunciators) and then change to the show the software version.
3. With the software version displayed, press and hold the  $\Rightarrow 0 \Leftarrow$  key.
4. The display will change to show the  $\llcorner RP$  prompt, the current Scale Capacity setting and turn on the CAL (calibration annunciator).
5. The scale is now ready for setup and calibration

While in Setup, the current setting prompt will be shown in the smaller upper seven-segment display, while the value of the current setting will be shown in the large lower seven-segment display. Note, that when moving through the setup prompts, the default or previously selected value appears first on the display.

## Setup Navigation Keys



This is the **Enter** key. Press the  key to accept the current displayed setting of the parameter and advance to the next setup prompt.



This is the **Lock/Release** key. Press the  key to return to the previous setup prompt.



### (Arrow Keys)





These keys are used when selecting setup values. Pressing the  $\uparrow$  or  $\downarrow$  keys will increase or decrease the value of the selected parameter or toggle between the available parameter values.

Each press of the the  $\uparrow$  key will increase the displayed setup parameter value by one-step or toggle between available values.

Each press of the  $\downarrow$  key will decrease the displayed setup parameter value by one-step or toggle between available values.





**NOTE:** When entering the scale capacity ( $\llcorner RP$ ) and calibration load value ( $\llcorner RLd$ ) pressing and holding the arrow keys allow you too rapidly, increase, or decrease the displayed setup parameter value.

### **CRP (SCALE CAPACITY)**

The display will show *CRP* and the current setting. If the value displayed is acceptable, press the  key. Otherwise, press the  or  keys to select a new value and then press the  key to save it and proceed to the next prompt.





This is the maximum allowed weight of the scale. It should be set to 600.0.

### **Int (INTERVAL SETTING)**

The display will show *Int* and the current setting. If the value displayed is acceptable, press the  key. Otherwise, press the  or  keys to select a new value and then press the  key to save it and proceed to the next prompt.

This is the minimum graduation of the scale. Allowable settings are 1, 2, or 5.





### **dEC (DECIMAL POINT POSITION)**

The display will show *dEC* and the current setting. If the value displayed is acceptable, press the  key. Otherwise, press the  or  keys to select a new value and then press the  key to save it and proceed to the next prompt.

This is the decimal point precision of the scale. Allowable settings are 0, 1, 2, or 3.





0 = XXXXX    1 = XXXX.X    2 = XXX.XX    3 = XX.XXX

### **SR (SAMPLE RATE)**

The display will show *SR* and the current setting. If the value displayed is acceptable, press the  key. Otherwise, press the  or  keys to select a new value and then press the  key to save it and proceed to the next prompt.

This is the number of times per second the load cell is sampled. Allowable values are a minimum of 1 sample per second to a maximum of 10 samples per second in one sample per second intervals.





### **Units (WEIGHING UNITS)**

The display will show *Units* and the current setting. If the value displayed is acceptable, press the  key. Otherwise, press the  or  keys to toggle the weighing units between lb (pounds) or kg (kilograms) and then press the  key to save it and proceed to the next prompt.

This is the weighing units of the scale. Allowable settings are lb (pounds) or kg (kilograms).

**NOTE:** The height units are determined by the weighing units selected. For example, if the weighing units are lb (pounds) the height units will be in feet/inches.





### **FILt (DIGITAL FILTER MODE)**

The display will show *FILt* and the current setting. If the value displayed is acceptable, press the  key. Otherwise, press the  or  keys to select a new value and then press the  key to save it and proceed to the next prompt.

This is the amount of digital filtering applied to the scale. Allowable settings are 0, 1, 2, or 3.





0 = Off            1 = Minimal    2 = Moderate    3 = Maximum

### ***nn0t (MOTION RANGE)***

The display will show *nn0t* and the current setting. If the value displayed is acceptable, press the  key. Otherwise, press the  or  keys to select a new value and then press the  key to save it and proceed to the next prompt.





The motion range is the number of divisions of change permitted before indicating unstable (the STABLE annunciator turns off). Allowable values are 1 to 10.

### ***EUr0 (OIML)***

The display will show *EUr0* and the current setting. If the value displayed is acceptable, press the  key. Otherwise, press the  or  keys to toggle the OIML selection between *YES* or *no* and then press the  key to save it and proceed to the next prompt.





This setting controls the OIML (European) specific requirements. Allowable settings are *YES* for EU or *no* for US.

### ***PU0 (Power Up Zero)***

The display will show *PU0* and the current setting. If the value displayed is acceptable, press the  key. Otherwise, press the  or  keys to toggle the power up zero between *YES* or *no* and then press the  key to save it and proceed to the next prompt.





This setting controls zeroing of the scale on power up. If enabled, the scale will be reset to zero automatically on power up. Allowable settings are *YES* or *no*.

### ***0tr (Zero Tracking)***

The display will show *0tr* and the current setting. If the value displayed is acceptable, press the  key. Otherwise, press the  or  keys to select a new value and then press the  key to save it and proceed to the next prompt.

This setting controls the automatic zero tracking of the scale. Allowable values are 0 to 10, indicating the number of half-divisions above or below zero that the scale will attempt to maintain the zero position. **NOTE:** Select 0 (zero) to disable zero tracking.

### ***SEr 1 (Com1 Mode)***

The display will show *SEr 1* and the current setting. If the value displayed is acceptable, press the  key. Otherwise, press the  or  keys to toggle the Com1 Mode between *Cont* (continuous output), *POLL* (weight on demand) and *SP0t* (Welch-Allyn Spot LXi interface) then press the  key to save it and proceed to the next prompt.





This setting controls the output for Com 1. Allowable settings are *Cont*, *POLL* or *SP0t*.

If *Cont* (continuous output) was selected for Com 1, the scale will continuously transmit weight data.

If *POLL* (Weight-On-Demand) was selected for Com 1, and the scale is connected to a computer for transmission of weight data to a PC-based EMR (electronic medical record) software program, it will transmit a single set of weight data each time the computer sends a weight request "ENQ" (hex 05) or a SMA weight request "W".

If *SP0t* (Welch-Allyn Spot LXi interface) was selected for Com 1, the scale will automatically interface to a Welch-Allyn Spot LXi interface device to transmit weight data.

### **5Er2 (Com2 Mode)**

The display will show *5Er2* and the current setting. If the value displayed is acceptable, press the  key. Otherwise, press the  or  keys to toggle the Com2 Mode between *Cont* (continuous output), *POLL* (weight on demand) and *Spot* (Welch-Allyn Spot LXi interface) then press the  key to save it and proceed to the next prompt.





This setting controls the output for Com 2. Allowable settings are *Cont*, *POLL* or *Spot*.

If *Cont* (continuous output) was selected for Com 2, the scale will continuously transmit weight data.

If *POLL* (Weight-On-Demand) was selected for Com 2, and the scale is connected to a computer for transmission of weight data to a PC-based EMR (electronic medical record) software program, it will transmit a single set of weight data each time the computer sends a weight request "ENQ" (hex 05) or a SMA weight request "W".



If *Spot* (Welch-Allyn Spot LXi interface) was selected for Com 2, the scale will automatically interface to a Welch-Allyn Spot LXi interface device to transmit weight data.

### **U5b (USB Mode)**

The display will show *U5b* and the current setting. If the value displayed is acceptable, press the  key. Otherwise, press the  or  keys to toggle the USB Mode between *PHdC* (Personal Healthcare Device Class), *Cont* (continuous output) or *POLL* (weight on demand) and then press the  key to save it and proceed to the next prompt.





This setting controls the output for the USB device port. Allowable settings are *PHdC*, *ALLYn*, or *SMA*.

If *PHdC* (Personal Healthcare Device Class) was selected for USB, the scale will transmit data using the CEN ISO/IEEE 11073 Medical / Health Device Communication Standard.

If *ALLYn* (Welch Allyn) was selected for USB, the scale will automatically transmit data to a Welch Allyn CVSM Device when the weight on the scale stabilizes and the   (STABLE) annunciator turns on. (Requires device to have an activated license. Must purchase Detecto WACONNECT)

If *SMA* (SMA, Weight-On-Demand) was selected for USB, and the scale is connected to a computer for transmission of weight data to a PC-based EMR (electronic medical record) software program, it will transmit a single set of weight data each time the computer sends a weight request "ENQ" (hex 05) or a SMA weight request "W".

### **YERr (YEAR)**

The display will show *YERr* and the current setting. If the value displayed is acceptable, press the  key. Otherwise, press the  or  keys to select a new value and then press the  key to save it and proceed to the next prompt.

This is the current year setting of the real time clock. Allowable values are 2015 to 2099.

### ***MONTH* (MONTH)**

The display will show *MONTH* and the current setting. If the value displayed is acceptable, press the **←** key. Otherwise, press the **↑** or **↓** keys to select a new value and then press the **←** key to save it and proceed to the next prompt.

This is the current month setting of the real time clock. Allowable values are 1 to 12.

1 = January	5 = May	9 = September
2 = February	6 = June	10 = October
3 = March	7 = July	11 = November
4 = April	8 = August	12 = December

### ***DAY* (DAY)**

The display will show *DAY* and the current setting. If the value displayed is acceptable, press the **←** key. Otherwise, press the **↑** or **↓** keys to select a new value and then press the **←** key to save it and proceed to the next prompt.

This is the current day setting of the real time clock. Allowable values are 1 to 31.

### ***HOUR* (HOUR)**

The display will show *HOUR* and the current setting. If the value displayed is acceptable, press the **←** key. Otherwise, press the **↑** or **↓** keys to select a new value and then press the **←** key to save it and proceed to the next prompt.

This is the current hour setting of the real time clock. Allowable values are 0 to 23.

**NOTE:** The hour is entered in a 24-hour format. When entering the hour after noon (12:00 PM), you must add 12 to time. For example, 3:00 PM would be entered as 15.

### ***MIN* (MINUTE)**

The display will show *MIN* and the current setting. If the value displayed is acceptable, press the **←** key. Otherwise, press the **↑** or **↓** keys to select a new value and then press the **←** key to save it and proceed to the next prompt.

This is the current minute setting of the real time clock. Allowable values are 0 to 59.

### ***SEC* (SECONDS)**

The display will show *SEC* and the current setting. If the value displayed is acceptable, press the **←** key. Otherwise, press the **↑** or **↓** keys to select a new value and then press the **←** key to save it and proceed to the next prompt.





This is the current seconds setting of the real time clock. Allowable values are 0 to 59.

### ***HELT* (Sonar Height Calibration)**

The display will show *HELT* and the current setting *NO*. To calibrate the sonar sensor, press the **↑** or **↓** keys to select *YES*, and then press the **←** key. The display will show *CLERR* for approximately four seconds indicating you should step away from the sensor at a distance of at least 6 feet as it prepares to calibrate. After approximately four seconds, the display will briefly show *BUSY* as the sonar sensor calibrates.

**NOTE:** Movable objects that might interfere with the sound waves of the sensor should be removed from a 6-foot radius. Objects that are not easily movable (walls, a desk, large heavy objects that stay in one-spot) can be left in place. These larger objects will be masked away in the calibration process.





## 5 Ht (SENSOR HEIGHT)

The display will show 5 Ht and the current setting. If the value displayed is acceptable, press the  key. Otherwise, press the  or  keys to select a new value and then press the  key to save it and proceed to the next prompt.

This is the height in *centimeters* from the scale platform to the bottom of the sonar height sensor. This value is used to determine the patient's height, and should be measured, and entered as accurately as possible to ensure accurate height measurements.

## HOLD (HOLD TIME)



This setting is used by the scale to hold a stable patient weight for a desired amount of time. For example, if a value of 5 seconds is used, then when the scale locks onto a stable patient weight, it will remain locked for 5 seconds before automatically releasing the weight.

The display will show HOLD and the current setting. If the value displayed is acceptable, press the  key. Otherwise, press the  or  keys to select a new value and then press the  key to save it and proceed to the next prompt.

This setting controls the auto-locking feature. Allowable values for hold time are 0 to 20.





## CR (CALIBRATION)

The display will show CR and the current setting *no*. If the scale has been previously calibrated and you wish to skip calibration and proceed to the *TYPE* (Scale Model) prompt, press the  key and the previous calibration will be retained.

To begin calibration, press the  key to select YES and then press the  key. After pressing the  key, the display will change to LOAD.

## LOAD (LOAD CALIBRATION WEIGHT)

With the display showing LOAD, perform the following steps:

1. Make certain the scale platform is empty and free of debris.
2. Place the desired amount of calibrated test weights on the scale platform. A minimum of 50% of scale's capacity is required. However, 70% to 100% is recommended.
3. Press the  key.
4. If the value displayed is acceptable, press the  key again. Otherwise, determine the exact amount of test weight placed on the scale platform and then using the  or  keys select the test weight amount.
5. Verify that the numbers selected are the same as the amount of the test weight and then press the  key.
6. Starting at the left and preceding right, a series of dashes will appear on the display. The dashes will stay on the display momentarily, then disappear, after which the display will proceed to the next prompt.

## UNLOAD (UNLOAD CALIBRATION WEIGHT)

After a moment, the display will change to UNLOAD.

1. Remove the test weights from the scale platform and then press the  key.
2. Starting at the left and preceding right, a series of dashes will appear on the display. The dashes will stay on the display momentarily, then disappear, after which the calibration factor will be saved and the display will proceed to the next prompt.



**IMPORTANT:** During the time the dashes are appearing on the display, ensure that the loaded (or empty) scale is stable.







### GRAV (Gravity Compensation)

Gravity compensation accounts for latitudes and elevations that are different from where the scale was calibrated. In order to calculate the value for this parameter, use the gravitational constant of the location where the scale was calibrated divided by the gravitational constant of where the scale will be installed:

$$\frac{\text{Gravitational Constant (Calibration location)}}{\text{Gravitational Constant (Operation location)}} = \text{value}$$





This should give you a value close to 1 that you can enter in to compensate for variation in gravity due to elevation/latitude.

The display will show GRAV and the current setting. If the value displayed is acceptable, press the  key. Otherwise, press the  or  keys to select a new value and then press the  key to save it and proceed to the next prompt.

Allowable values for GRAV are 0.000 to 2.000.

**NOTE: The default value is 1.000, which means there is no gravity compensation.**

### TYPE (Scale Model)

The display will show TYPE and the current setting. If the value displayed is acceptable, press the  key. Otherwise, press the  or  keys to toggle the Scale Model between *APEX* (apex®) or *CUST* (custom, not applicable at this time) and then press the  key to save it. You will be returned to the CAP prompt, the current Scale Capacity setting.

This will change the default settings and operation of the scale. For instance, select *APEX* for type in order to use the stand-up type scale for the scale with the inline height rod or sonar height rod.

Allowable settings are *APEX* or *CUST*.

### Setup and Calibration is Complete

The setup and calibration process have been completed. Press the  key to turn the scale off and then press it again to turn the scale back on. The scale is now ready for normal operation.

# DATA FORMAT

## **Cont (Continuous Output)**

If *Cont* (continuous output) was selected, the scale will continuously transmit weight data in SMA format (see below).

## **POLL (Weight-On-Demand)**

If *POLL* (Weight-On-Demand) was selected and the scale is connected to a host device (computer) for transmission of weight data to a PC-based EMR (electronic medical record) software program, it will transmit a single set of weight data each time the host device (computer) sends a SMA weight request "W" or a weight request "ENQ" (hex 05). An example and explanation of the data format transmitted is shown below.

## **SMA Format (Cont or POLL)**

This format is used if the scale is configured for *Cont* (continuous output) *OR* if the scale is configured for *POLL* (weight-on-demand) and the host device (computer) sends:

<LF>W<CR>

or

<ENQ> (hex 05)

The scale will respond with the following SMA weight string:

<LF>S1GM^DDDDDDDDDDUUU<CR>

Where:

LF =	Line Feed	Line feed character (hex 0A)
S =	Status	O = Over Cap, Z = Center Zero, U = Below Zero, E = Error
1 =	the number 1	
G =	Mode of operation	G = Gross, N = Net, T = Tare
M =	Motion bit	M = Motion, " "(blank) = Settled (no motion)
^ =	Space	
DDDDDDDDDD =	Weight	Weight with decimal point if necessary
UUU =	Units	e. g. lb, kg
CR =	Carriage Return	Carriage Return (hex 0D)

# EVENT COUNTER

Your apex® Digital Clinical Scale has been designed with an Event Counter type of security seal. When selected, the scale will display two numbers representing the Calibration and Configuration counters.





## Calibration Counter

The calibration counter is incremented when a value in the calibration part of setup is changed (*CRP, Unit, dEC, Sr, Unit, Filter, mode, EUR0, CAL, GRAV, TYPE*). The counter is only incremented 1 time even if more than one parameter is changed each time through setup.

## Configuration Counter



The configuration counter is incremented when a value in the configuration part of setup is changed (*PUD, Otr, SER1, SER2, USB, YEAR, month, DAY, HOUR, mode, SEC, SHt, Hold*). The counter is only incremented 1 time even if more than one parameter is changed each time through setup.

### To Review the Event Counter:

1. Press the  key to turn the scale on.
2. The scale will perform a display test (turn on all segments and annunciators) and then change to the show the software revision for a few seconds.
3. Next, the display will change to the Weight Display with the  $\rightarrow 0 \leftarrow$  (ZERO) and  $\blacktriangle \blacktriangle$  (STABLE) annunciators turned on to show a stable, center-of-zero weight condition.
4. Press and hold the  key.
5. The display will change to show all dashes and then the software revision.
6. Release the  key.
7. The display will change to show *CAL* (Calibration Counter) on the small upper seven-segment display and up to a 3-digit number on the large lower seven-segment display for approximately two (2) seconds.
8. Next, the display will then show *CFG* (Configuration Counter) on the small upper seven-segment display and up to a 3-digit numbers on the large lower seven-segment display for approximately two (2) seconds and then change to show all dashes.
9. To return to the normal operation, press the  key.
10. Otherwise, press the  key to turn the scale off.

## ERROR AND OPERATION MESSAGES

The apex® scale is equipped with diagnostic software that tests various portions of the scale's circuitry and verifies proper operation. Should a problem be detected, an error or status message will be displayed. The following lists these messages and their meaning.

Display	Meaning
→0←	This symbol appears when the scale weight reading is at center of zero.
	This symbol appears if the weight has been manually locked by pressing the  key.
-----	This message appears if the  key has been pressed without any weight on the scale.
OCAP	The weight on the scale weight exceeds scale capacity.
ErrOF	This message appears if there are too many characters to display. For example, attempting to display a negative number greater than -9,999 or a positive number greater than 99,999.
Lo bAtt	When the batteries are near the point they need to be replaced, the scale display will show <i>Lo</i> on the small upper seven-segment display and <i>bAtt</i> on the large lower seven-segment display. Note that when the battery voltage drops too low for accurate weighing, the scale will automatically shut off and you will be unable to turn it back on.
CAL 1b	The scale requires calibration. The weight will show as dashes. Consult your scale service representative.
AdErr ErrAL ErrAH	} Consult your scale service representative.

## BEFORE YOU CALL FOR SERVICE

Problem	Possible Solutions
Display does not turn on	<p>AC Operation:</p> <ul style="list-style-type: none"> <li>• Is AC power supply fully inserted into wall receptacle?</li> <li>• Check wall receptacle for proper AC power. Try another electrical appliance in same receptacle. Does it work?</li> <li>• Check circuit breaker.</li> <li>• Has there been power failure?</li> </ul> <p>Battery operation:</p> <ul style="list-style-type: none"> <li>• Check if batteries are installed and correctly.</li> <li>• If Alkaline, remove old batteries, and replace with new ones.</li> <li>• If NI-CAD or NiMH, remove discharged batteries and replace with fully charged ones. Place discharged batteries in an external charger to recharge.</li> </ul>
Incorrect weight is displayed	Ensure that scale platform is not touching an adjacent object. Have proper operation procedures been followed?
Weight is not displayed	Refer to Error and Operation Messages.

## CARE AND CLEANING



**NOTE:** The scale contains no user-serviceable parts and maintenance should be limited to an occasional cleaning and battery replacement as required.

- Do not submerge the scale in water, pour, or spray water directly on it to clean. The scale is not waterproof and covering it with water will damage it and void the warranty.
- Always remove power before cleaning.
- Do not use wire brushes, abrasives, or cleaning tools such as steel pads and scrapers, which will scratch the painted surface. Instead, use soft cloths or plastic scouring pads for cleaning.
- When possible, use treated water. Hard water can leave behind deposits. Soft water is much gentler on the painted steel's surface.
- Avoid the use of acetone, thinner or other volatile solvents, and abrasive type cleaners for cleaning. If required, a mild solvent such as mineral spirits can be used to remove oil, grease, tars, wax, and similar substances. Use a cloth dampened with mineral spirits, and apply only to contaminated areas. Follow up the use of this mild solvent with detergent cleaning and rinsing.

# PARTS IDENTIFICATION

## APEX (with mechanical height rod)

### FINAL ASSEMBLY

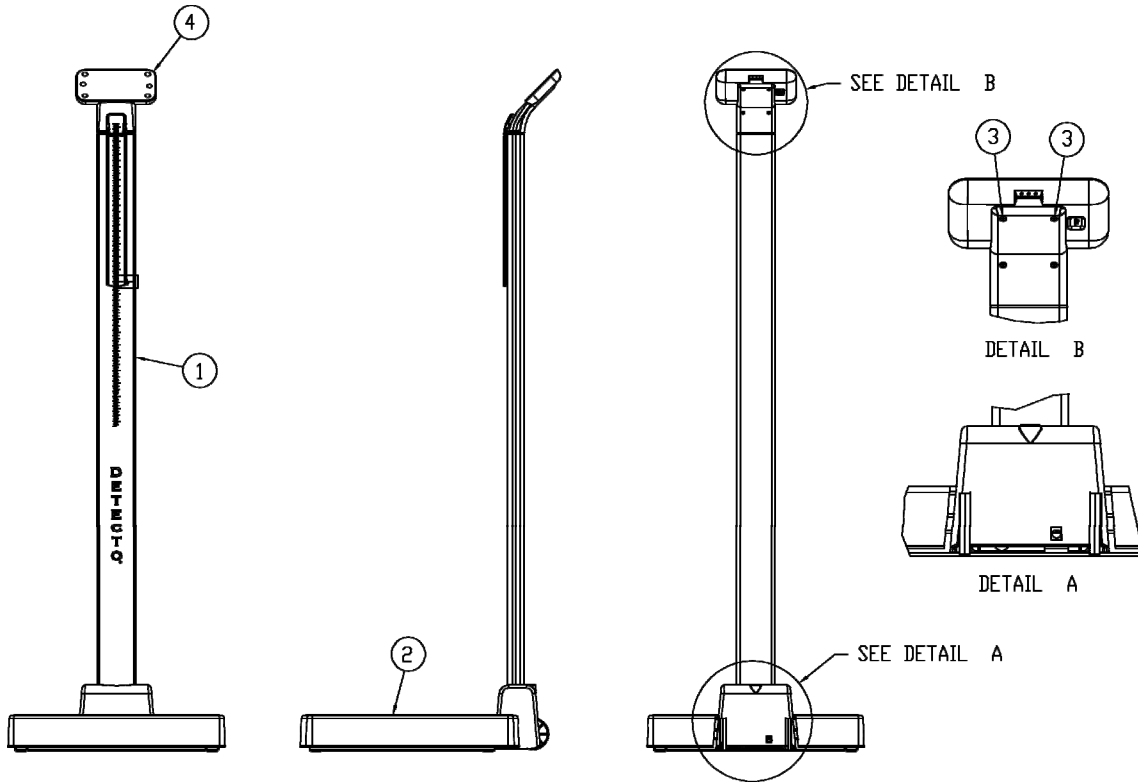

Item	Qty.	Part Number	Description
1	1	3300-0142-0A	SUB-ASSY, APEX COLUMN, MHR
2	1	3300-0145-0A	SUB-ASSY, APEX BASE
3	2	6021-1293	SCW FLAT-HEAD THREAD CUTTING TYPE 25, #4-24 X 1/4, PHIL. DR. Z-PLATE
4	1	3300-0153-0A	SUB-ASSY, DISPLAY, APEX
*	1	6800-1045	OPTIONAL AC ADAPTER 100-240VAC/12VDC @ 1 AMP

\* NOT SHOWN

**PARTS IDENTIFICATION**  
**APEX (with mechanical height rod)**  
**COLUMN SUB-ASSEMBLY**

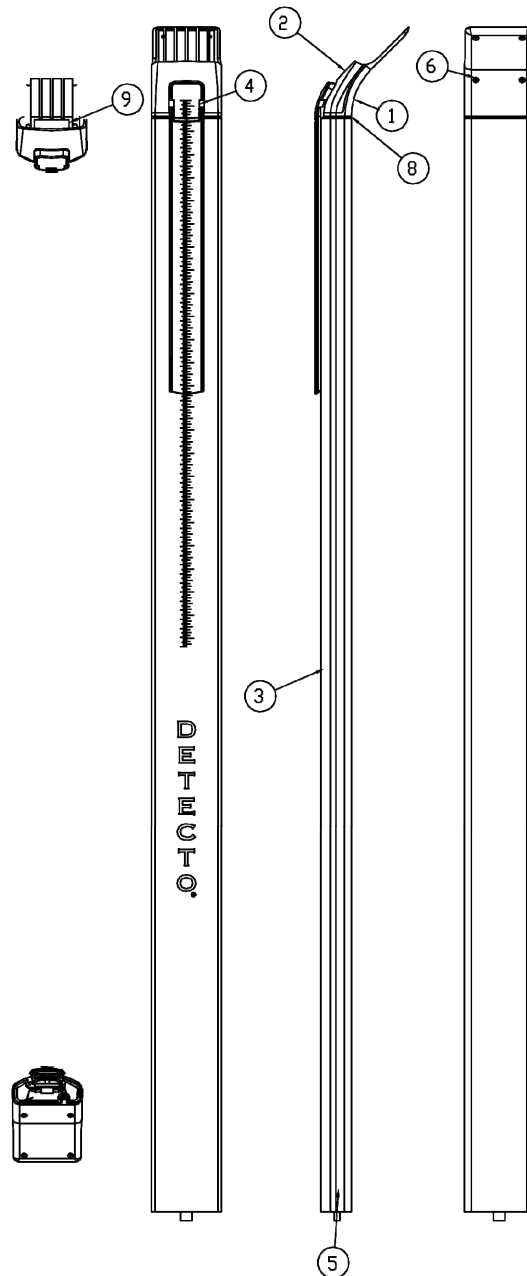

Item	Qty.	Part Number	Description
1	1	3300-0067-08	THROAT REAR
2	1	3300-0069-08	THROAT FRONT, MHR
3	1	3300-0087-18	COLUMN, DRILLED
4	1	3300-0146-0A	SUB-ASSY, MHR
5	1	3300-0278-0A	APEX COLUMN CABLE MHR
6	2	6021-1293	SCW FLAT-HEAD THREAD CUTTING TYPE 25, #4-24 X 1/4, PHIL. DR. Z-PLATE
7	1	6021-1509	SCW PAN-HEAD, SHEET METAL #8X.75
8	1	6650-1114	O-RING 2 ID X 2-3/16 OD X 3/32 THK
9	1	8530-B159-08	SEALING TAB

**PARTS IDENTIFICATION**  
**APEX-SH (with sonar height rod)**  
**FINAL ASSEMBLY**

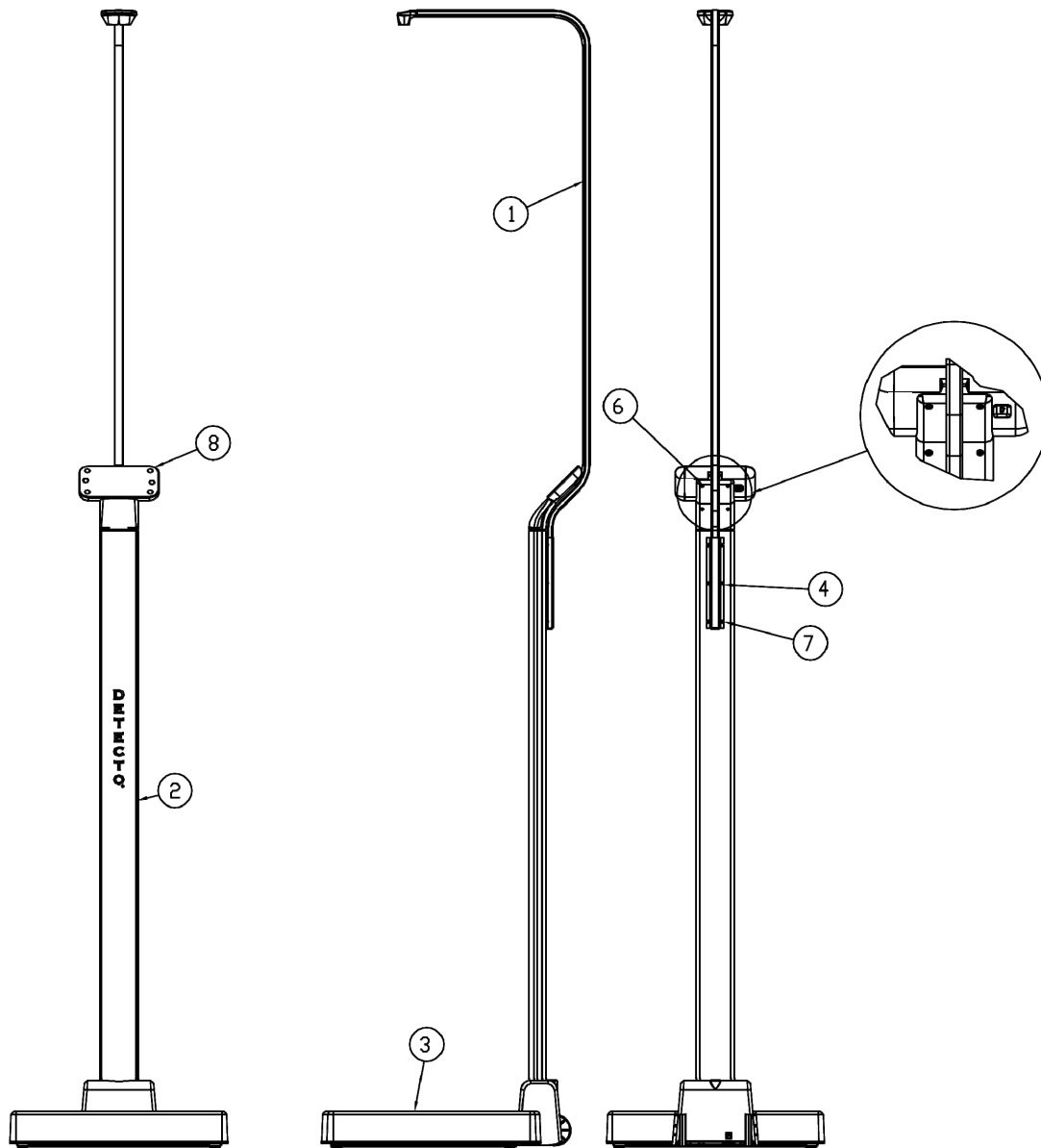

Item	Qty.	Part Number	Description
1	1	3300-0140-0A	SUB-ASSY, SONAR HR
2	1	3300-0143-0A	SUB-ASSY, APEX COLUMN, SONAR
3	1	3300-0145-0A	SUB-ASSY, APEX BASE
4	1	3300-0265-08	SONAR BRACKET
5	1	6013-0049	NUT 1/4-20 HEX JAM
6	2	6021-1293	SCW FLAT-HEAD THREAD CUTTING TYPE 25, #4-24 X 1/4, PHIL. DR. Z-PLATE
7	6	6021-6017	SCW ROUND-HEAD BLUNT SS. SHEET METAL #6 X .25
8	1	3300-0152-0A	SUB-ASSY, DISPLAY, APEX-SH
*	1	6800-1045	OPTIONAL AC ADAPTER 100-240VAC/12VDC @ 1 AMP

\* NOT SHOWN



**PARTS IDENTIFICATION**  
**APEX-SH (with sonar height rod)**  
**COLUMN SUB-ASSEMBLY**

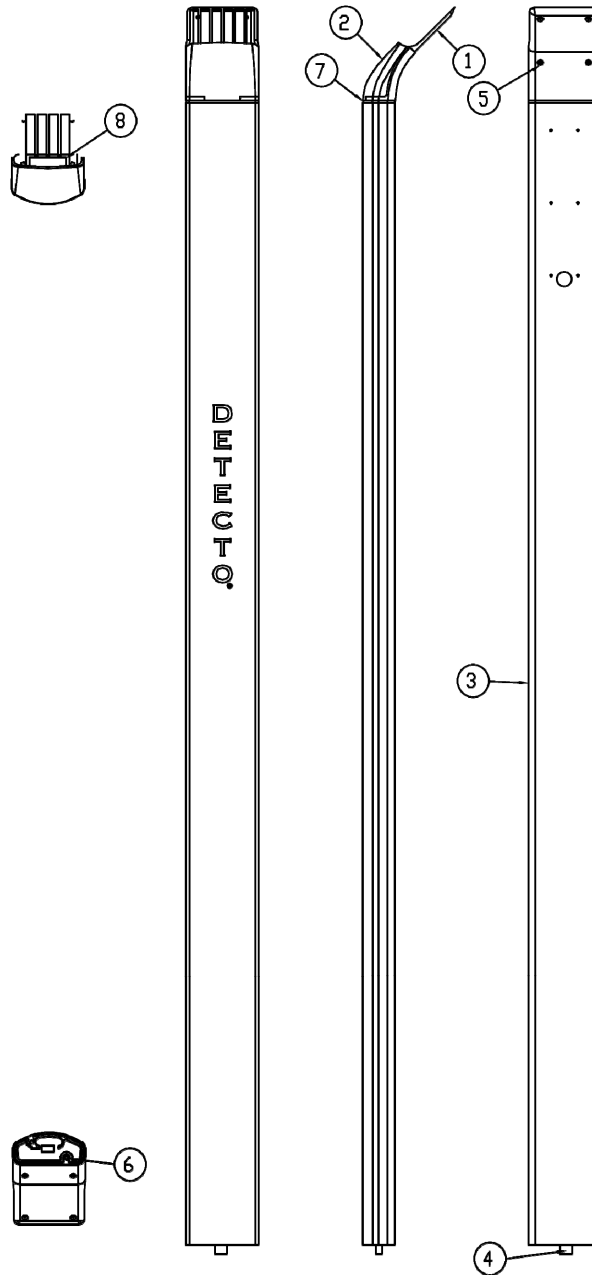

Item	Qty.	Part Number	Description
1	1	3300-0067-08	THROAT REAR
2	1	3300-0068-08	THROAT FRONT
3	1	3300-0087-08	COLUMN, DRILLED & SONAR
4	1	3300-0278-1A	CABLE, APEX COLUMN, SONAR
5	2	6021-1293	SCW FLAT-HEAD THREAD CUTTING TYPE 25, #4-24 X 1/4, PHIL. DR. Z-PLATE
6	1	6021-1509	SCW PAN-HEAD, SHEET METAL #8X.75
7	1	6650-1114	O-RING 2 ID X 2-3/16 OD X 3/32 THK
8	1	8530-B159-08	SEALING TAB

# PARTS IDENTIFICATION

## SONAR HEIGHT ROD SUB-ASSEMBLY

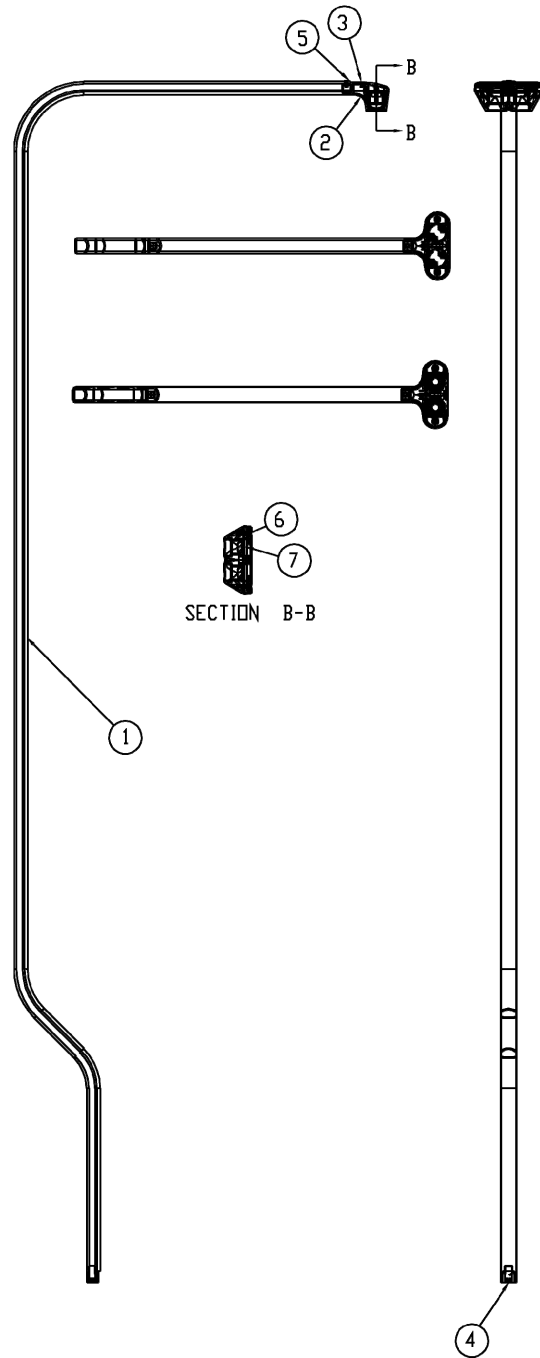

Item	Qty.	Part Number	Description
1	1	3300-0022-08	HEIGHT SENSOR TUBE
2	1	3300-0060-08	SONAR FRONT ENCLOSURE
3	1	3300-0061-08	SONAR REAR ENCLOSURE
4	1	3300-0135-0A	CABLE, ICON/APEX SONAR
5	1	6021-1293	SCW FLAT-HEAD THREAD CUTTING TYPE 25, #4-24 X 1/4, PHIL. DR. Z-PLATE
6	2	6021-2078	SCW PAN HEAD PHILIPS #1-32X3/8" THREAD FORMING, 18-8 SS
7	1	3300-0039-2A	ULTRASONIC RANGING MODULE

## PARTS IDENTIFICATION DISPLAY SUB-ASSEMBLY

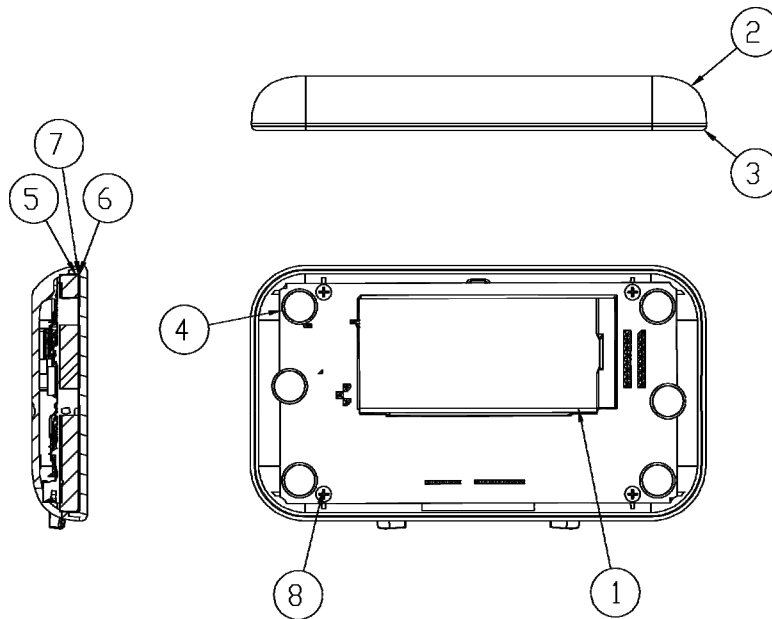

VIEW WITH FRONT DISPLAY AND UNDERLAYS REMOVED

Item	Qty.	Part Number	Description
1	1	3300-0042-0A	PCB ASS'Y 755 CONTROLLER/DISPLAY
2	1	3300-0050-08	DISPLAY ENCLOSURE
3	1	3300-0052-08	DISPLAY FRONT, APEX
4	6	3300-0072-08	APEX BUTTONS
5	1	3300-0089-08	UNDERLAY FOAM, APEX
6	1	3300-0150-08 3300-0149-08	UNDERLAY, APEX UNDERLAY, APEX-SH
7	1	3300-0154-08	UNDERLAY BACKING, APEX
8	4	6021-1286	SCW PAN-HEAD THREAD CUTTINT TYPE 25, #4X1/4, PHIL. DR. Z-PLATE

**PARTS IDENTIFICATION  
BASE SUB-ASSEMBLY**

Item	Qty.	Part Number	Description
1	1	3300-0053-08	COLUMN CLAMP
2	1	3300-0058-28	SOCKET COVER, APEX
3	2	3300-0059-08	WHEELS
4	2	3300-0082-08	LOAD CELL SPACER
5	1	3300-0086-0A	APEX WEIGHBRIDGE
6	1	3300-0094-0A	APEX BASE WELDMENT
7	1	3300-0136-1A	CABLE, APEX BATTERY
8	1	3300-0138-1A	CABLE, APEX LOAD CELL
9	1	3300-0147-0A	SUB-ASSY, PLATFORM COVER, APEX
10	4	6013-0049	NUT 1/4-20 HEX JAM
11	2	6013-2006	PUSH NUT, 1/4"
12	4	6013-2008	NUT 1/4-20 CAGE Z/P
13	4	6021-0654	SCW PAN-HEAD, MACHINE-SCW 06-32X.250
14	4	6021-1417	SCW SOCKET-HD. CAP-SCREW,,.25-20X2.0
15	8	6021-1550	SCW FLAT-HEA, CAP-SCREW M8X1.25X30MM
16	4	6540-1122	FOOT, RUBBER, N .81 DIAMETER, ADHESIVE
17	A/R	6560-1061	ADHESIVE LOCTITE 262-21 THREADBLOCKER, HS
18	1	6690-0001	LEVEL, "BULLSEYE" TYPE
19	1	593GR986	SERIAL TAG ASSY

# PARTS IDENTIFICATION

## BASE SUB-ASSEMBLY

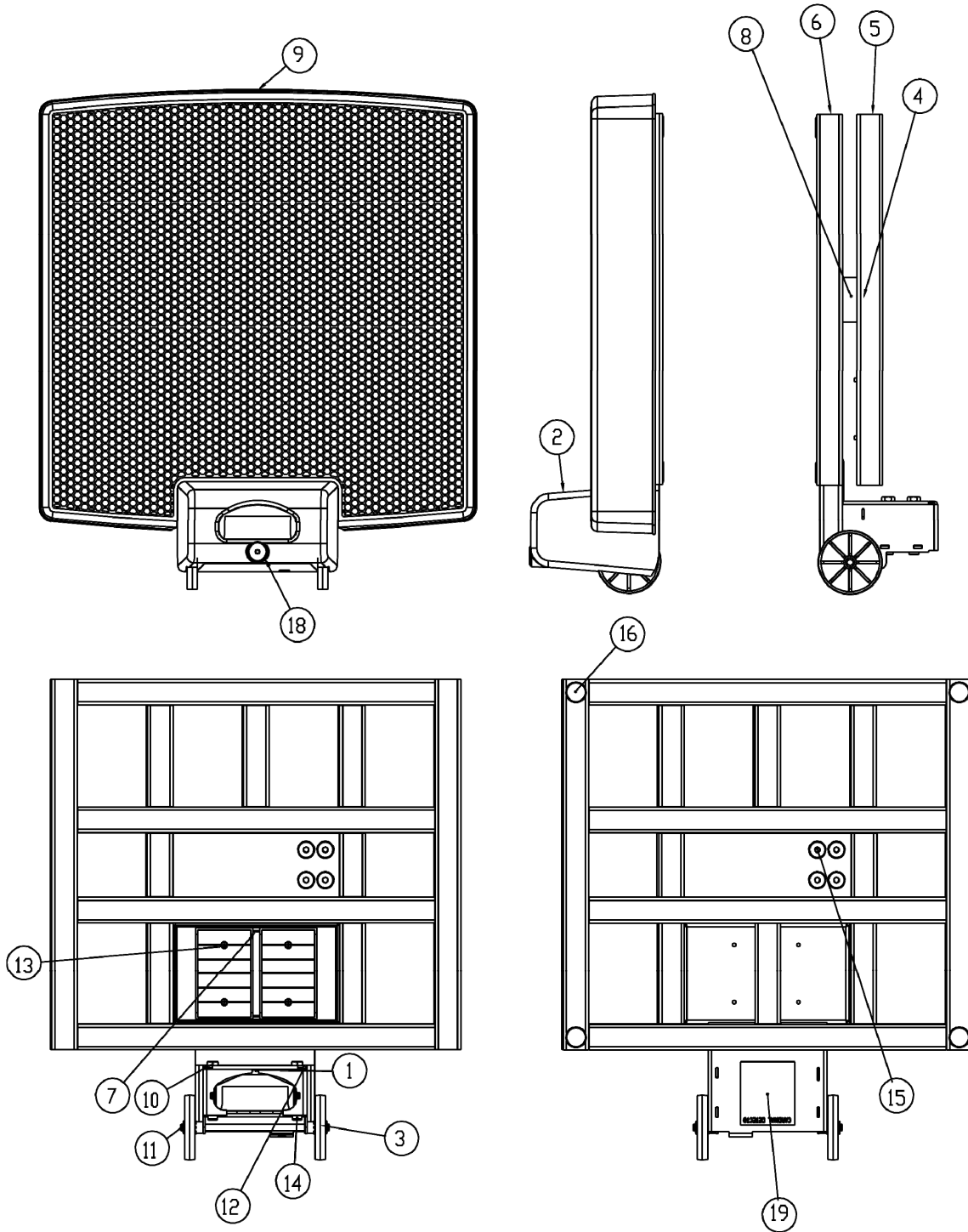

## STATEMENT OF LIMITED WARRANTY

Detecto Scale warrants its equipment to be free from defects in material and workmanship as follows: Detecto warrants to the original purchaser only that it will repair or replace any part of equipment, which is defective in material or workmanship for a period of two **(2) years from date of shipment**. Detecto shall be the sole judge of what constitutes a defect.

During the **first ninety (90) days**, Detecto may choose to replace the product at no charge to the buyer upon inspection of the returned item.

**After the first ninety (90) days**, upon inspection of the returned item, Detecto will repair or replace it with a remanufactured product. The customer is responsible for paying for the freight both ways.

This warranty does not apply to peripheral equipment not manufactured by Detecto; this equipment will be covered by certain manufacturer's warranty only.

This warranty does not include replacement of expendable or consumable parts. This does not apply to any item, which has deteriorated or damaged due to wear, accident, misuse, abuse, improper line voltage, overloading, theft, lightning, fire, water, or acts of God, or due to extended storage or exposure while in purchaser's possession. This warranty does not apply to maintenance service. Purchased parts will have a ninety (90) day repair or replacement warranty only.

Detecto may require the suspect product to be returned to the factory; item(s) must be properly packed and shipping charges prepaid. A return authorization number must be obtained for all returns and marked on the outside of all returned packages. Detecto accepts no responsibility for loss or damage in transit.

# STATEMENT OF LIMITED WARRANTY

## Conditions Which Void Limited Warranty

This warranty shall not apply to equipment which:

- A.) Has been tampered with, defaced, mishandled or has had repairs and modifications not authorized by Detecto.
- B.) Has had serial number altered, defaced, or removed.
- C.) Has not been grounded according to Detecto's recommended procedure.

## Freight Carrier Damage

Claims for equipment damaged in transit must be referred to the freight carrier in accordance with freight carrier regulations.

This warranty sets forth the extent of our liability for breach of any warranty or deficiency in connection with the sale or use of the product. Detecto will not be liable for consequential damages of any nature, including but not limited to, loss of profit, delays, or expenses, whether based on tort or contract. Detecto reserves the right to incorporate improvements in material and design without notice and is not obligated to incorporate improvements in equipment previously manufactured.

The foregoing is in lieu of all other warranties, express or implied including any warranty that extends beyond the description of the product including any warranty of merchantability or fitness for a particular purpose. This warranty covers only those Detecto products installed in the forty-eight (48) contiguous continental United States.



Ph. (800) 641-2008  
E-mail: [detecto@cardet.com](mailto:detecto@cardet.com)  
203 E. Daugherty  
Webb City, MO 64870

08/27/2014  
Printed in USA  
D268-WARRANTY-DET-A



Printed in USA

3300-0188-0M Rev K 04/19



Cardinal Scale Manufacturing Co.  
102 E. Daugherty, Webb City, MO 64870 USA  
Ph: 417-673-4631 or 1-800-641-2008  
Fax: 417-673-2153

Technical Support: 1-866-254-8261  
E-mail: [tech@cardet.com](mailto:tech@cardet.com)