



SOLO®
DIGITAL CLINICAL SCALES



Models
SOLO-RI
PD100

solo Series

Digital Clinical Scale

Owner's Manual

TABLE OF CONTENTS

INTRODUCTION	1
SPECIFICATIONS	1
FEATURES	2
solo EYE-LEVEL PHYSICIAN SCALE	3
Unpacking	3
Scale Assembly	4
solo-RI REMOTE INDICATOR SCALE	7
Unpacking	7
Scale Assembly	7
Wall Mounting the solo-RI Display	7
Desk or Table Mounting the solo-RI Display	9
CARPET FEET INSTALLATION	10
WEIGHING UNIT SELECTION	11
Scale Initialization	11
BATTERY OPERATION	12
Battery Installation or Replacement	12
Low Battery	13
Automatic Shutoff	13
OPTIONAL AC POWER ADAPTER	14
KEYPAD FUNCTIONS	15
ANNUNCIATORS	17
OPERATION	18
Weighing Mode.....	18
solo Height Rod Operation	19
Height and/or BMI Measure Mode (using solo Height Rod or Previously Measured Height)	20
Optional BMI Mode	20
MOTHER/BABY WEIGHING	21
SCALE SETUP	22
CALIBRATION	25
Changing the Weighing Unit	25
DATA TRANSMISSION FORMAT	27
Data Transmission via USB	27
Output Format	27
Remote Print Command	27
DISPLAY MESSAGES	28
TROUBLESHOOTING	28
CARE AND CLEANING	29
PARTS IDENTIFICATION	30
Display and Column Sub-Assembly	31
Base Sub-Assembly	32
Height Rod Sub-Assembly	33

Proper Disposal

When this device reaches the end of its useful life, it must be properly disposed of. It must not be disposed of as unsorted municipal waste. Within the European Union, this device should be returned to the distributor from where it was purchased for proper disposal. This is in accordance with EU Directive 2002/96/EC. Within North America, the device should be disposed of in accordance with the local laws regarding the disposal of waste electrical and electronic equipment.

It is everyone's responsibility to help maintain the environment and to reduce the effects of hazardous substances contained in electrical and electronic equipment on human health. Please do your part by making certain that the device is properly disposed of. The symbol shown to the right indicates that this device must not be disposed of in unsorted municipal waste programs.



FCC Compliance Statement

This equipment generates, uses, and can radiate radio frequency and if not installed and used in accordance with the instruction manual, may cause interference to radio communications. It has been designed within the limits for a Class A computing device pursuant to Subpart J of Part 15 of FCC rules to provide reasonable protection against such interference when operated in a commercial environment. Operation of this equipment in a residential area may cause interference in which case the user will be responsible to take whatever measures necessary to correct the interference.

You may find the booklet "How to Identify and Resolve Radio-TV Interference Problems" prepared by the Federal Communications Commission helpful. It is available from the U.S. Government Printing Office, Washington, D.C. 20402. Request stock No. 001-000-00315-4.

Copyright



All rights reserved. Reproduction or use, without expressed written permission, of editorial or pictorial content, in any manner, is prohibited. No patent liability is assumed with respect to the use of the information contained herein.

Disclaimer

While every precaution has been taken in the preparation of this manual, the Seller assumes no responsibility for errors or omissions. Neither is any liability assumed for damages resulting from the use of the information contained herein. All instructions and diagrams have been checked for accuracy and ease of application; however, success and safety in working with tools depend to a great extent upon the individual's accuracy, skill, and caution. For this reason, the Seller is not able to guarantee the result of any procedure contained herein. Nor can they assume responsibility for any damage to property or injury to persons occasioned from the procedures. Persons engaging in the procedures do so entirely at their own risk.

Serial Number _____
Date of Purchase _____
Purchased From _____

RETAIN THIS INFORMATION FOR FUTURE USE

PRECAUTIONS	
Before using this scale, read this manual and pay special attention to all "NOTIFICATION" symbols:	
	
IMPORTANT	ELECTRICAL WARNING

INTRODUCTION

Thank you for purchasing our Detecto solo Series Digital Clinical Scale. Your scale has been designed for simple and straightforward use and to assure accuracy and dependability for years to come.

This manual is provided to guide you through the assembly and operation of your scale. Please read it thoroughly before attempting to assemble or operate your scale and keep it available for future reference.

This manual is for use with the following solo Series Digital Clinical Scales:

solo, solo-AC, solo-ACEU, solo-ACUK, and solo-RI

SPECIFICATIONS

Capacity:	550 lb x 0.2 lb (250 kg x 0.1 kg)
Minimum Weighing:	11 lb (5 kg)
Weight Units:	Pounds or Kilograms (selectable)
Power Requirements:	Six (6) AA-size Alkaline batteries (included) OR an optional medical device 9V AC/DC wall plug-in adapter (Detecto part number PD-ACKIT, includes UK plug, EU plug and USA plug).
Display:	Five-digit, seven-segment, 1.0-inch (25 mm) high LCD
Operation Temperature:	50 to 104 °F (+10 to +40 °C)
Function Keys:	On/Off, Zero, BMI Height, Enter, Lock/Release, Print, Up Arrow/Mother and Baby, and Down Arrow
Annunciators:	ZERO, LOCK, STA, HOLD, LB, KG, CM, FT/IN, HEIGHT, WEIGHT, BMI, AM, PM
Interface:	USB (ASCII Protocol)
Dimensions: Eye-Level Physician	14.2 in W x 19.4 in D x 52.1 in H (36.0 cm W x 49.3 cm D x 132.4 cm H)
Height Rod Units:	Inch or cm
Height Rod Range:	30 to 84.5 inches (76 to 214.5 cm)
Dimensions: solo-RI Base	14.2 in W x 15.8 in D x 2.4 in H (36.0 cm W x 40.2 cm D x 6.1 cm H)
Remote Display	7.8 in W x 5.1 in D x 3.0 in H (with mounting bracket) (19.8 cm W x 12.9 cm D x 7.7 cm H)
Weight: Eye-Level Physician	18.9 lb (8.6 kg)
solo-RI	11.1 lb (5.0 kg)

FEATURES

- Low-Profile platform (only 2.4 in / 6.1 cm high)
- Body Mass Index (BMI) calculation
- Mother and Baby Weighing mode
- OneWeigh weighing units locking into Pounds or Kilograms¹
- Manual input height 2 ft 0.0 in to 7 ft 10.5 in by 0.5 in (60.0 cm to 240.0 cm by 1cm)
- Audible beep confirmation (A short beep when a key is pressed, and a long beep for when weight is stable and locked.)
- Selectable Auto Shut-Off feature (up to 9 minutes)
- Auto Weight Lock feature on stable weight
- Power-Up Zero
- USB output function (ASCII protocol)
- Integral wheels on Eye-Level Physician scale
- Inline mechanical height rod on Eye-Level Physician scale
- Included wall or desk mount brackets for solo-RI display
- 7.25 ft (2.2 m) cable from scale base to solo-RI display to allow placing the display wherever it is easiest to read

¹ *The weighing units are selected at Scale Initialization (when the scale is powered on for the first time).*

solo EYE-LEVEL PHYSICIAN SCALE

Unpacking

Remove the Display with Upper Outside and Inside Column (already assembled), Lower Inside Column, Lower Outside Column, Scale Platform, and Hardware Pack from the shipping carton. After removing from the carton, check for any damage that may have taken place during shipment. *Keep and use the original carton and packing material for return shipment if it should become necessary.* The purchaser is responsible for filing all claims for any damages or loss incurred during transit. Remove all plastic wrapping, foam fillers, and cardboard material from the scale platform, display, and other components. You should have the following components:

- ① Display with Upper Outside and Inside Column (pre-assembled)
- ② Lower Inside Column
- ③ Lower Outside Column
- ④ Scale Platform (with Column Housing Cover)
- ⑤ Carpet Feet (Qty. 4)
- ⑥ Hardware Pack, containing:
 - (4) M5 x 15 Machine Screws
 - (4) Lock Washers
 - (2) M3 x 12 Screws

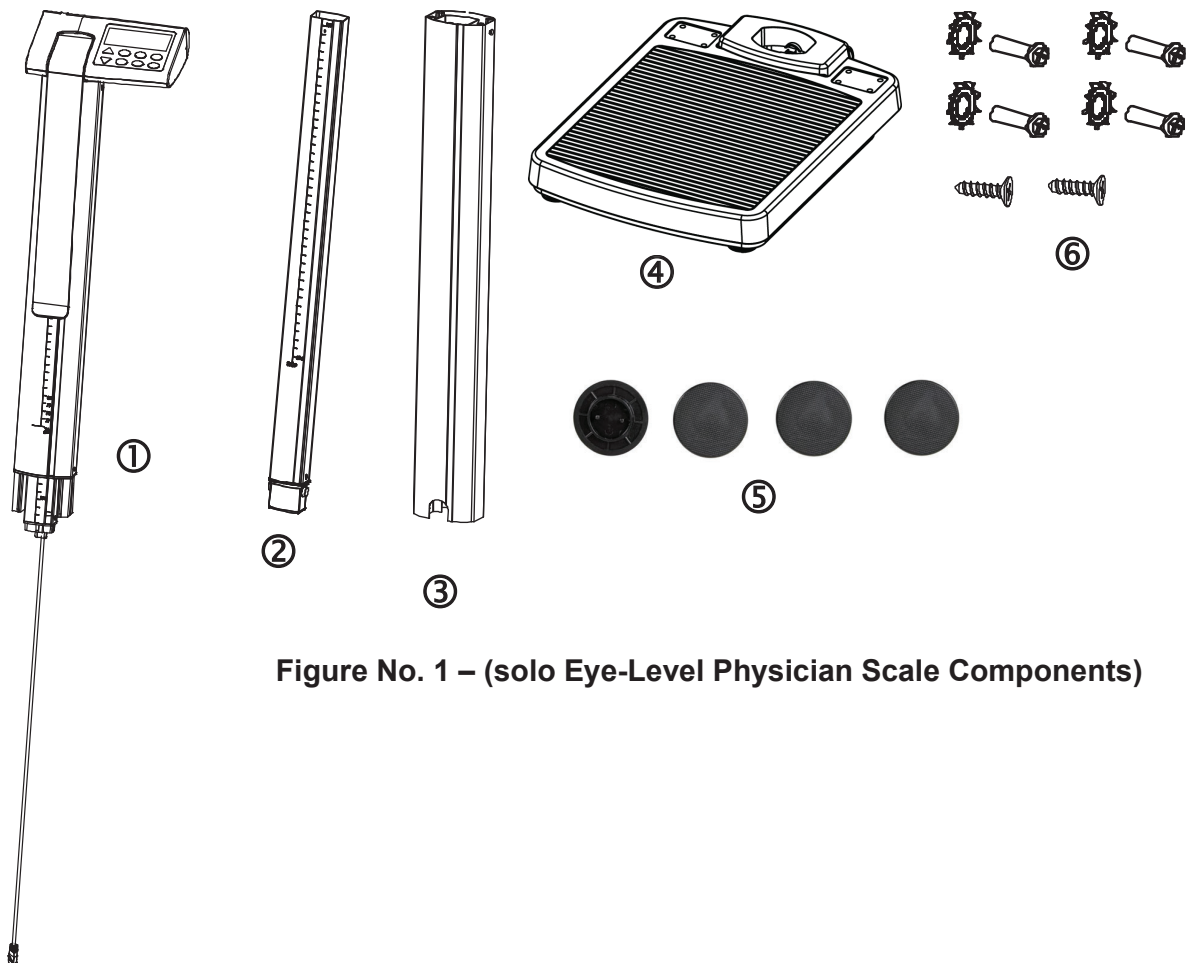

Figure No. 1 – (solo Eye-Level Physician Scale Components)

Scale Assembly

Step 1

1. Align Part 2 (lower inside column) with Part 1 (pre-assembled display upper outside and inside column).
2. Press the parts together until the locking tab snaps in place.
3. Ensure that the locking tab is locked securely.

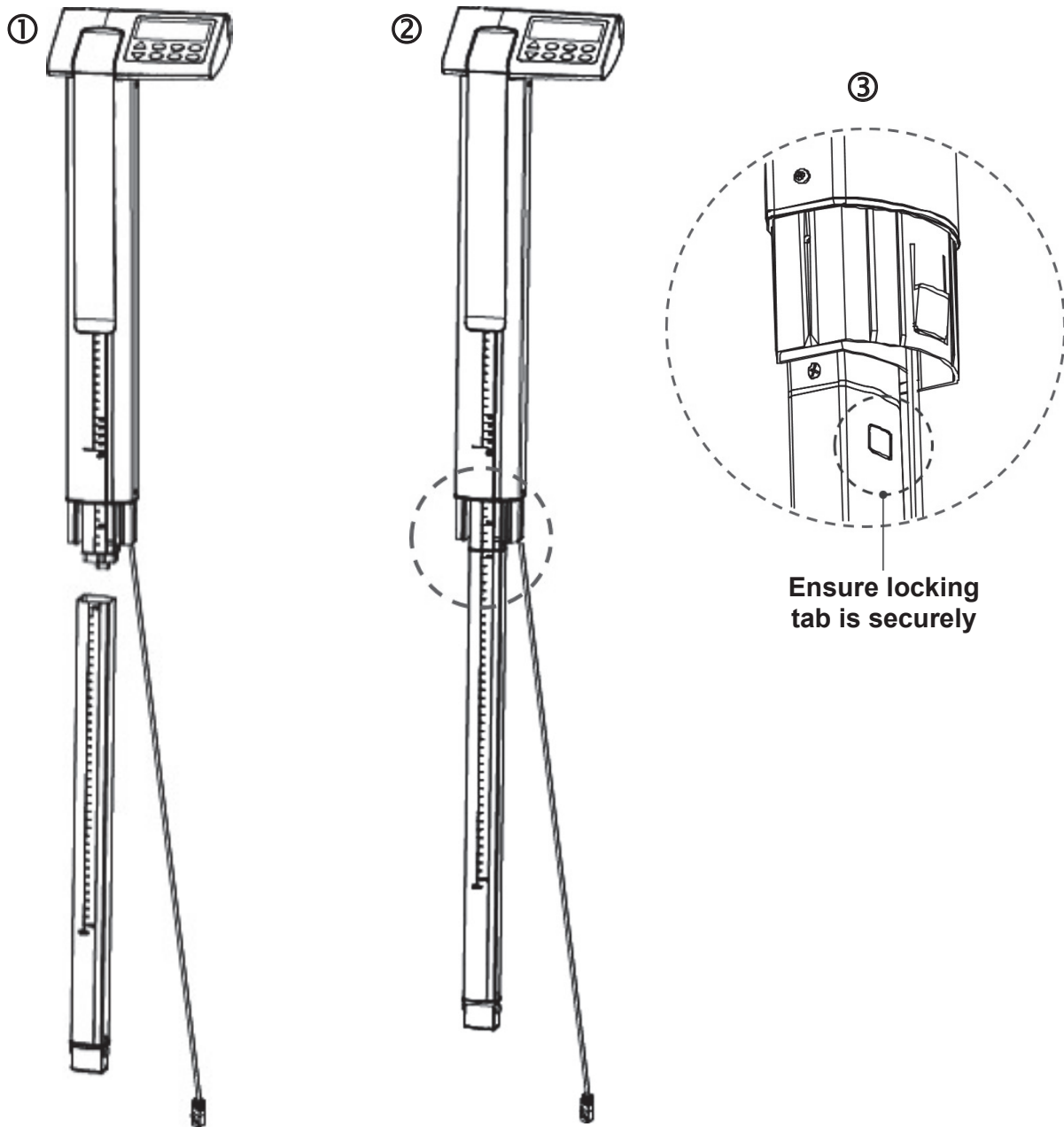

Figure No. 2
(Scale Assembly, Step 1)

Scale Assembly, Cont.

Step 2

1. Align Part 3 (lower outside column) with assembled Part 1 and 2 (display upper outside and inside column, and lower inside column).
2. Press the locking tab (on Part 2, lower inside column) inward and then insert it into Part 3 (lower outside column).
3. Slide the cable connector through Part 3 (lower outside column).
4. Press Part 3 and Part (1 and 2) together until the locking tab snaps in place.
5. Ensure that the locking tab is locked securely.
6. Install the (2) M3 x 12 machine screws (one on each side of Part 3) to secure Part 1 and 2 together with Part 3.

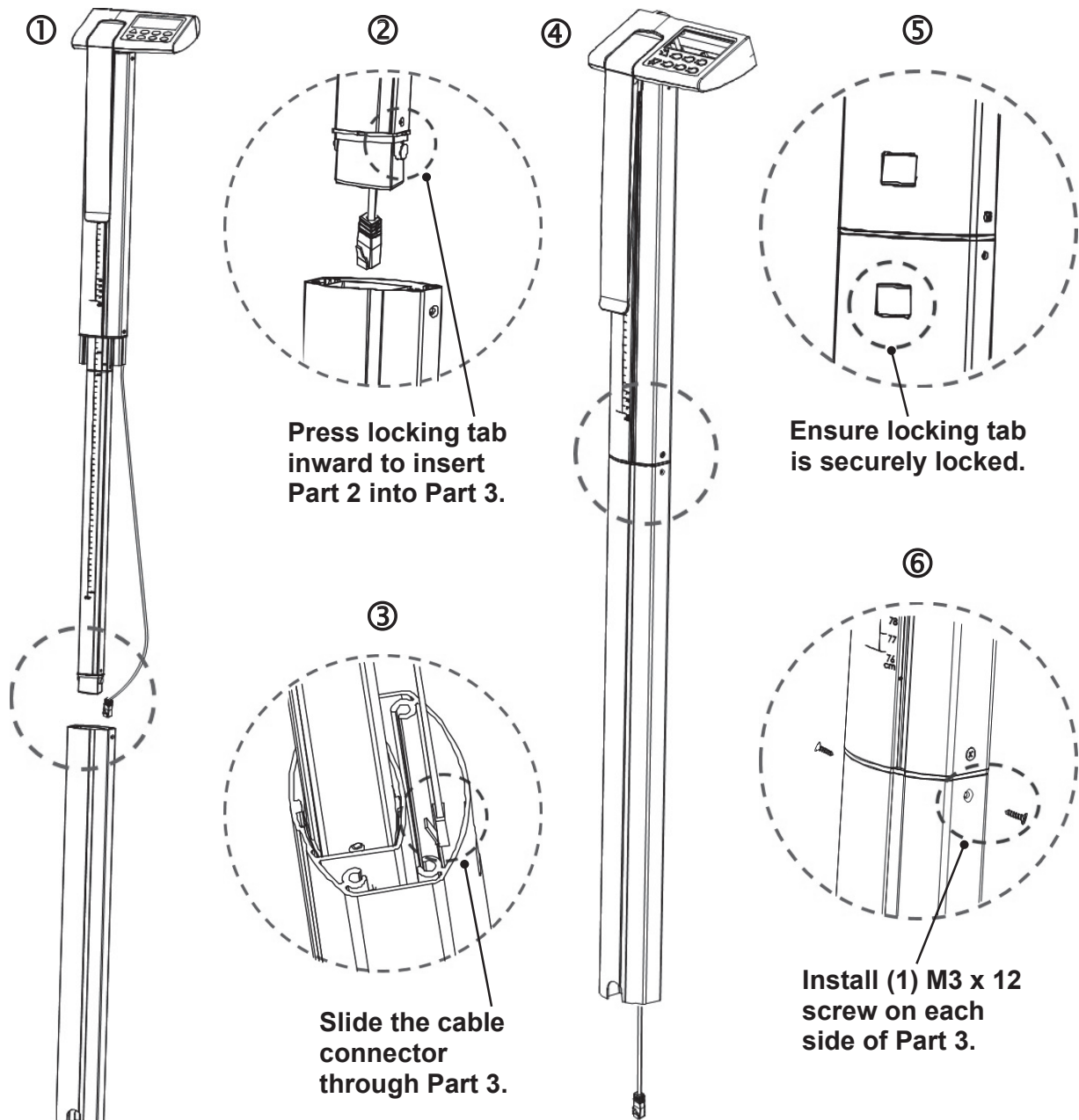

Figure No. 3
(Scale Assembly, Step 2)

Scale Assembly, Cont.

Step 3

1. Plug the cable connector into the RJ jack located on Part 4 (scale platform).
2. Align the display and assembled column with Part 4 (scale platform) and insert the column into the opening of the scale platform. **CAUTION!** To avoid pinching or cutting the cable, make sure the cable is not between the base and column when inserting the column into the base.
3. While holding the column in place, carefully lay the scale down with the column horizontal to the floor.
4. Attach the column to the scale platform by inserting the (4) M5 x 15 machine screws and lock washers through the holes in the scale platform into the threaded holes of the column. Tighten the screws to secure the column to the scale platform.

The scale should be placed on a flat, level hard-surfaced floor or low-cut, unpadded carpet, away from any rapidly moving air source (heating and cooling vents).

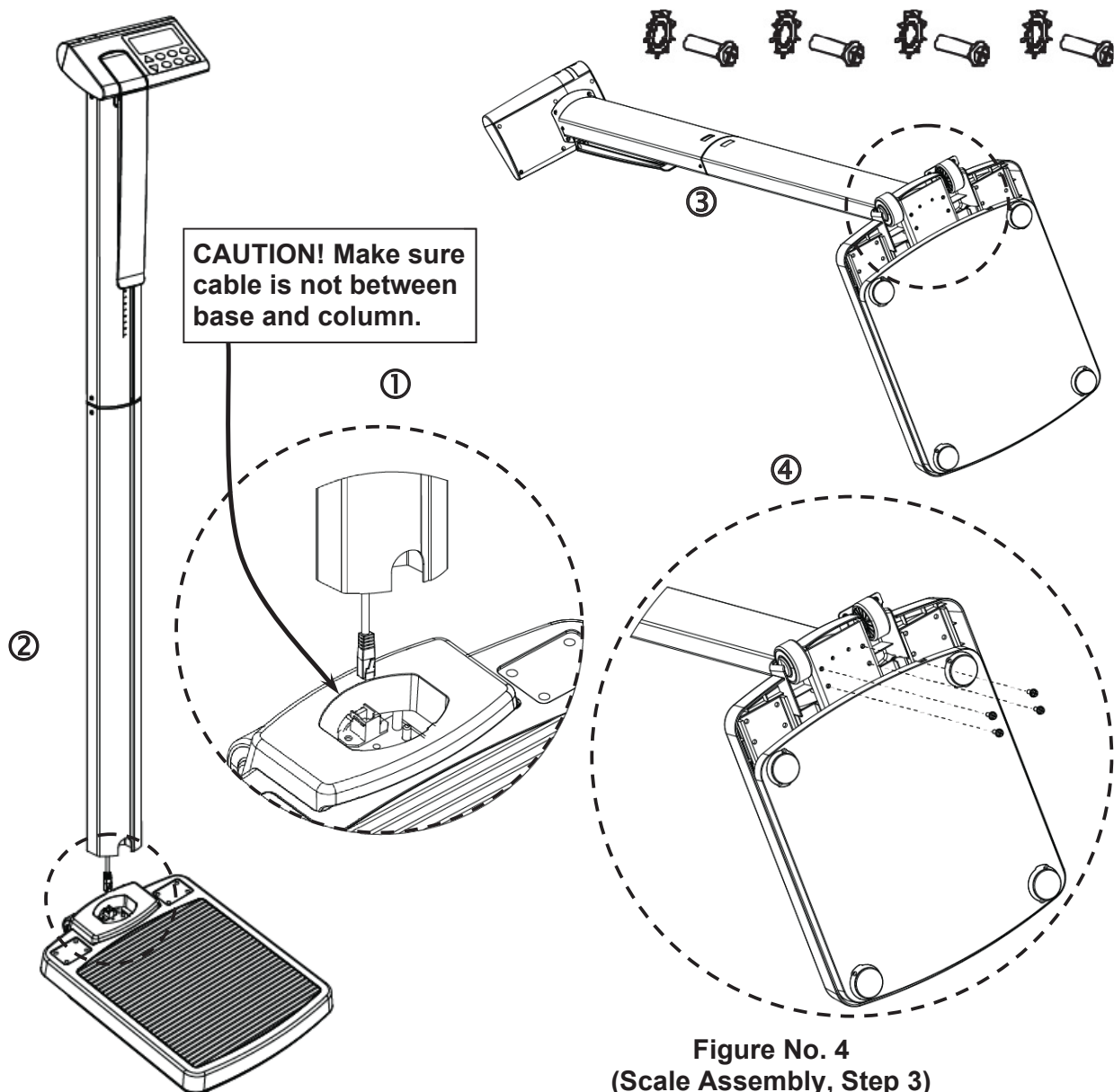

Figure No. 4
(Scale Assembly, Step 3)

solo-RI REMOTE INDICATOR SCALE

Unpacking

Remove the scale base, display, hardware pack, and other components from the shipping carton. After removing from the carton, check for any damage that may have taken place during shipment. *Keep and use the original carton and packing material for return shipment if it should become necessary.* The purchaser is responsible for filing all claims for any damages or loss incurred during transit. Remove all plastic wrapping, foam fillers, and cardboard material from the scale base, display, and other components. You should have the following components:

- (1) Scale Base with attached Display
- (1) Wall Bracket "A" (includes four (4) feet for desk or table mounting)
- (1) Wall Bracket "B"
- (1) Hardware Pack, containing:
 - (2) M3.0x25 Screws and plastic wall anchors

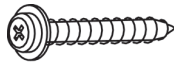
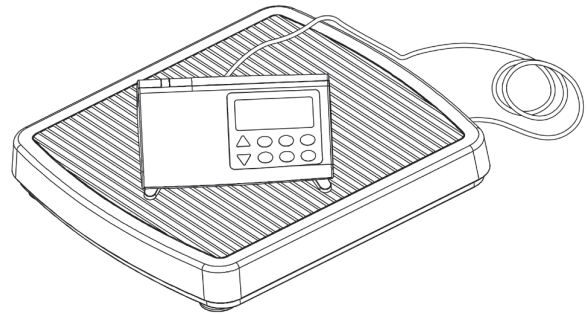

M3.0x25 Screw

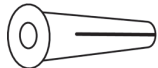

Plastic Wall Anchor

- (4) Carpet Feet



Scale Assembly

The solo-RI does not require any assembly. After installing batteries, the scale is ready for operation.

Wall Mounting the solo-RI Display

The solo-RI display has a 7.25 ft (2.2 m) cable to allow it to be placed at a convenient position away from the scale base. A bracket is included to mount the display on a wall, or the bracket (and included feet) can be used to place it on a desk or table for easy viewing.

1. Choose the location to mount the display on the wall. The location should be free of temperature extremes and water. It should be where the display can be easily viewed, not subject to direct sunlight, and where the keypad is within easy reach of the operator.
2. Make certain the structure and mounting hardware are of sufficient strength to support the display. The mounting bracket should be securely fastened to the wall so that it cannot break loose from the mounting surface.
3. Referring to Figure No. 5 and using Wall Bracket "B" for a template, place the bracket against the wall (the notch (*arrow*) pointing up) and mark the holes to use to mount it. Remove the bracket and drill two (2) 13/64 in (5 mm) holes in the wall for the mounting wall anchors.
4. Insert the wall anchors in the wall until they are flush with the wall.

Wall Mounting the solo-RI Display, Cont.

5. With the notch (*arrow*) pointing up on Wall Bracket "B", insert the two (2) M3.0x25 screws through the bracket and into the wall anchors.
6. Tighten the screws to secure the bracket to the wall.

Figure No. 5
(Installing Wall Bracket "B")

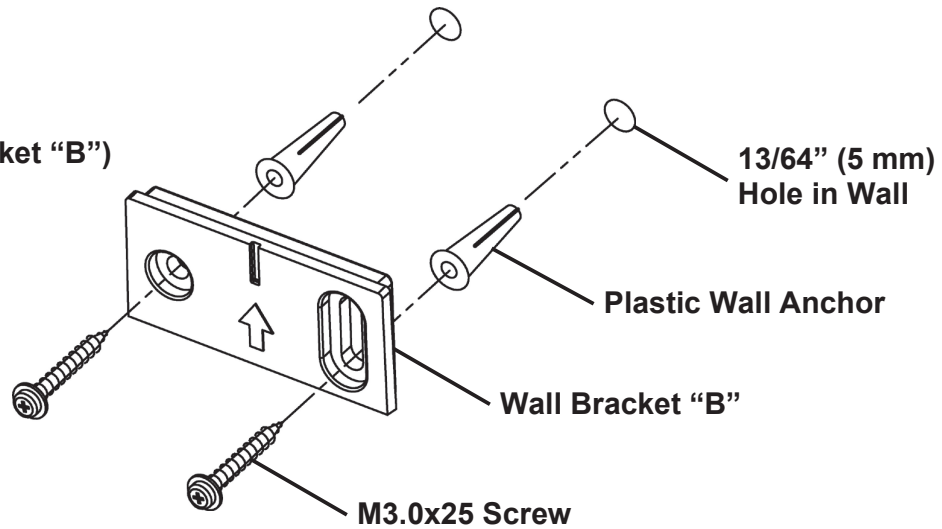

7. Referring to Figure No. 6, make sure the four (4) feet of Wall Bracket "A" are placed in the bracket.

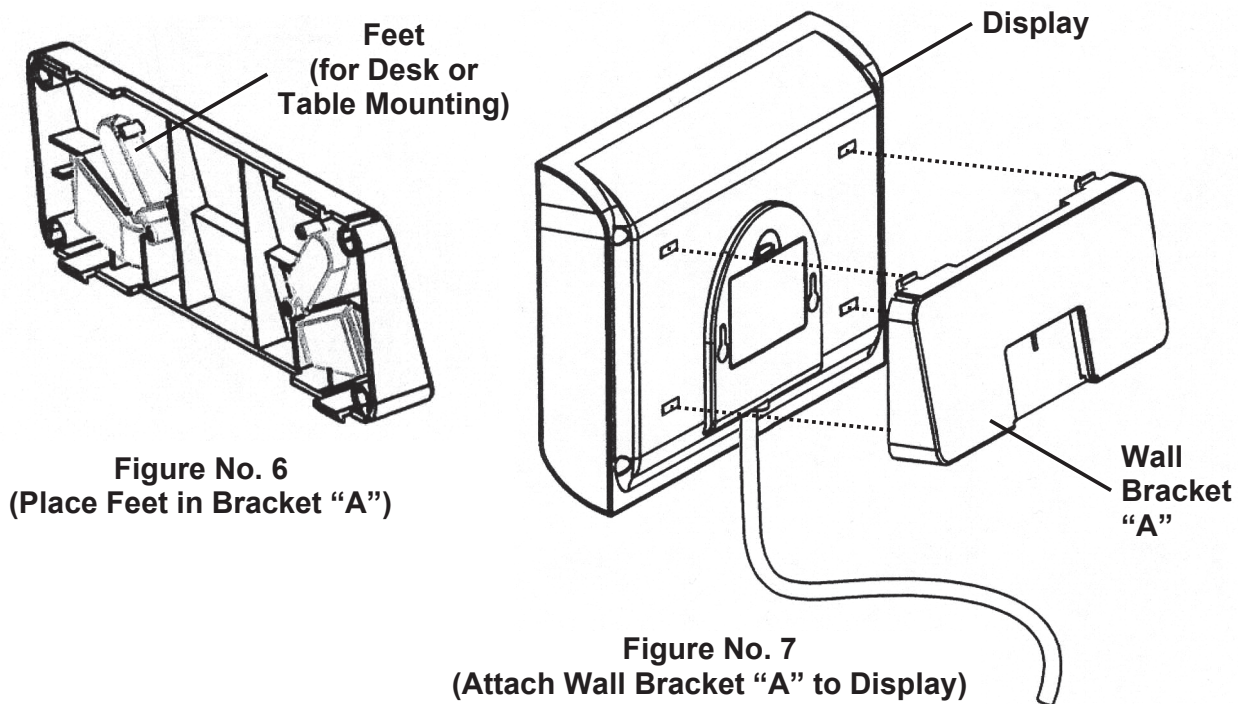

8. Next, locate the four (4) slots on the back of the display and align them with the four (4) tabs on the Wall Bracket "A". Refer to Figure No. 7.
9. Insert the tabs into the slots and press together until the bracket locks to the back of the display.

Wall Mounting the solo-RI Display, Cont.

10. Referring to Figure No. 8, align the cutout in Wall Bracket "A" with Wall Bracket "B" and gently pull it down to secure the display to the wall.

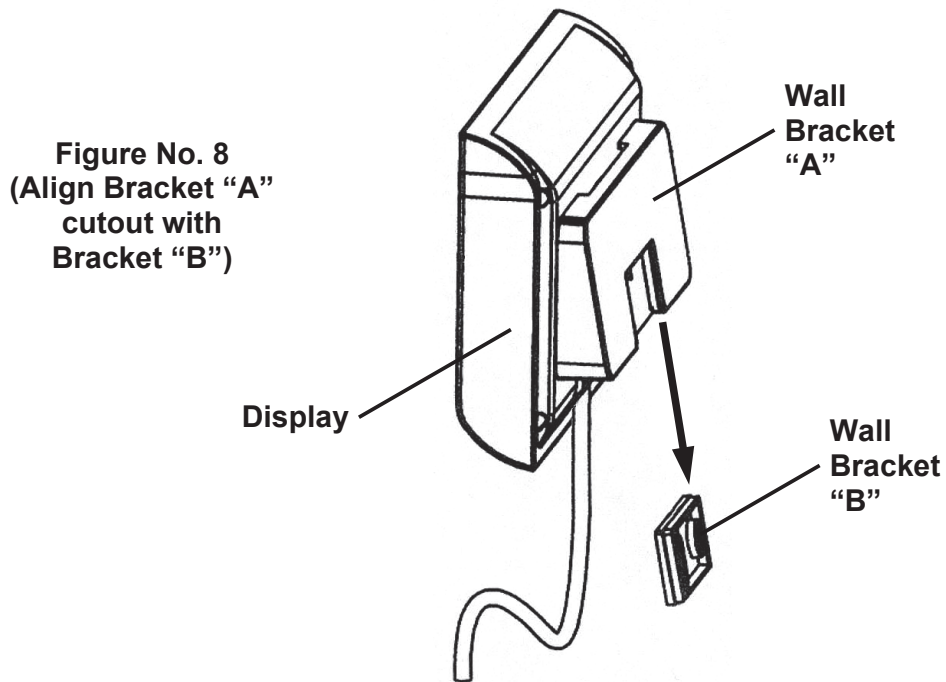

Desk or Table Mounting the solo-RI Display

1. The location chosen should be a stable, level surface (either a desk or solid table), free of temperature extremes and water. The display should be where it can be easily viewed, not subject to direct sunlight, and where the keypad is within easy reach of the operator.
2. Referring to Figure No. 9, remove the four (4) feet from inside Wall Bracket "A" and install them in each corner of the bracket as shown in Figure No. 10.

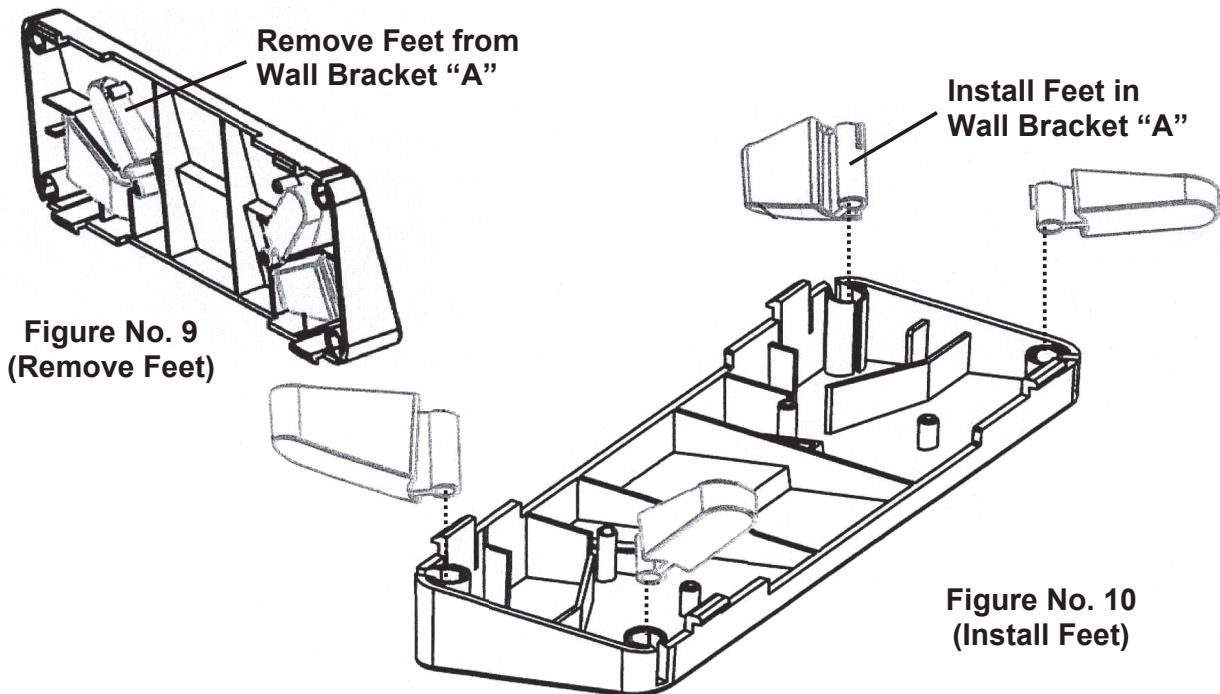

Desk or Table Mounting the solo-RI Display, Cont.

3. Next, locate the four (4) slots in the back of the display. Refer to Figure No. 11.
4. Referring to Figure No. 12, align and insert the tabs on the bracket with the slots in the display back and press together until the bracket locks to the back of the display.

Figure No. 11
(Locate Slots in
Display back)

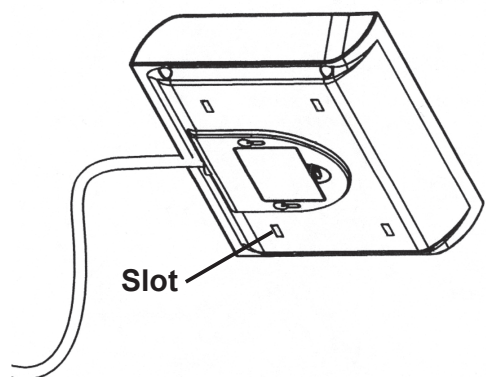
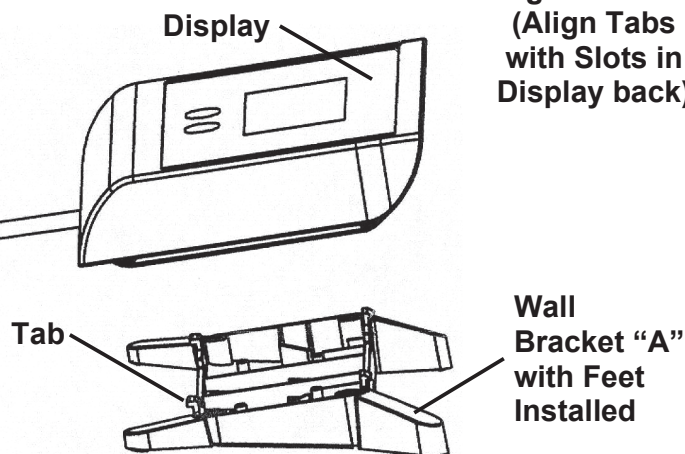

Figure No. 12
(Align Tabs
with Slots in
Display back)



CARPET FEET INSTALLATION

If you are using your solo Series Digital Clinical Scale on a carpet, we recommend that you use the included carpet feet. To install the carpet feet, perform the following steps:

1. Remove the four (4) carpet feet from the packaging.
2. Align the prongs of one carpet foot with the holes in one of the scale's existing feet.
3. Insert the carpet foot prongs into the holes, making sure the prongs align straight up and down with the holes of the scale foot.
4. Being careful not to twist the carpet foot, with even pressure, gently push straight down on the carpet foot to seat it into the scale foot.
5. Repeat steps 2 through 4 for the other three (3) scale feet.



WEIGHING UNIT SELECTION





NOTE: The following instructions apply to all models of the solo® Digital Clinical Scale, the Eye-Level Physician scale, and the solo-RI Remote Indicator scale.

Scale Initialization

When the scale is powered on for the *first* time, it will display a prompt to select the weighing unit to use for your operation, lb (pounds) or kg (kilograms). Make sure you select the correct weighing unit before proceeding.

1. Press the  key to turn the scale on.
2. The display will show all digits on the display, change to show the software version for a few seconds, and then show the current unit setting. Note that the default is **lb** (pounds).



3. If weighing in **lb** (pounds) is acceptable, press the  key. Otherwise, use the  or  keys to change the weighing unit to **kg** (kilograms) and then press the  key.



4. Once the unit is selected, it will be kept even after the batteries are replaced.
5. The scale is now ready for operation.

BATTERY OPERATION

To operate the solo Series Digital Clinical Scale from batteries, you must first install the included six (6) "AA" size alkaline batteries. Batteries are contained in a battery holder inside the display. Access is via a removable cover on the back of the display.

Battery Installation or Replacement

To install or remove the batteries, the following steps should be followed:

1. Remove the battery cover by pushing in on the arrow and sliding the cover approximately 3/4 in (20 mm) to the left, and then lifting it away from the display.

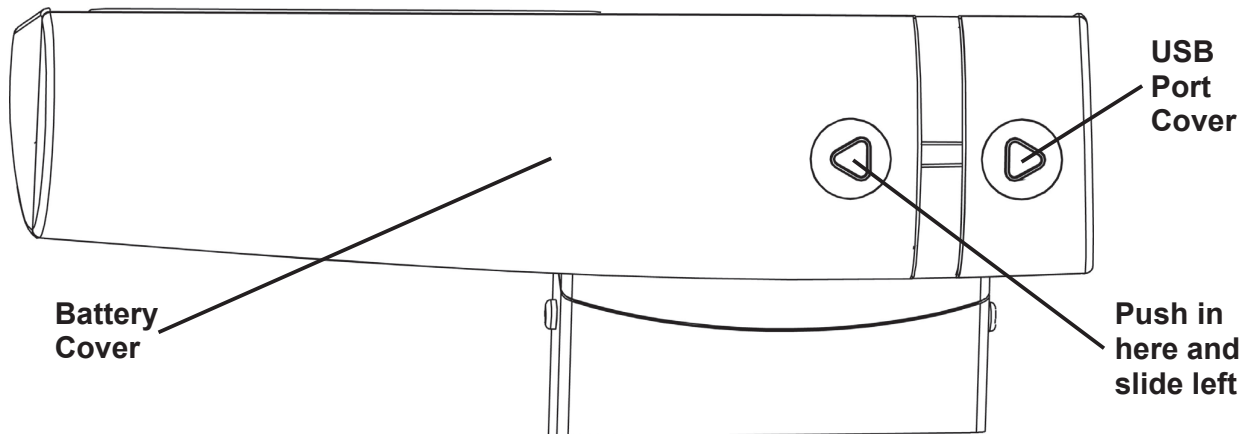

2. If installing new batteries, proceed to step 4. If replacing the batteries, remove all six (6) batteries from the battery holder, then proceed to step 4.
3. Install the six (6) new "AA" size batteries in the battery holder, noting the polarity markings located in the battery holder.

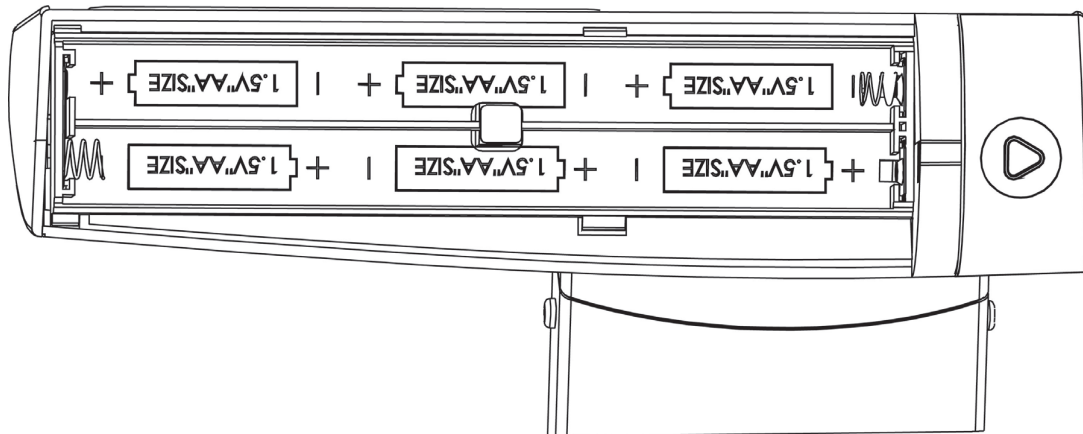

4. Replace the battery cover on the back of the display approximately 3/4 in (20 mm) from the right side of the display and then slide it to the right until it locks in place (it will click when locked in place).
5. The display should turn on, show the software version for a few seconds, followed by a small □ moving across the display, and then show 0.0 on the display.
6. The scale is now ready for operation.

NOTE: If the display did not turn on, remove the battery cover, and check for one or more improperly positioned batteries.

BATTERY OPERATION, CONT.

Low Battery

When the batteries are near the point they need to be replaced, *LoBAt* will be shown on the display. If the battery voltage drops too low for accurate weighing, the scale will shut off and you will be unable to turn it back on. When the *LoBAt* message is displayed, the operator should replace the batteries, or remove the batteries and plug in the 9V AC/DC adapter.

Automatic Shutoff

The Automatic Shutoff feature will turn the scale off after a period of inactivity (no motion or weight on the scale) to prolong battery life. The period of inactivity for the automatic shutoff is selected during the setup process of the scale and can be set for up to nine (9) minutes. To turn the scale back on, you simply press the  key.

OPTIONAL AC POWER ADAPTER

To power, the solo Series Digital Clinical Scale using the optional Medical device 9V AC/DC wall plug-in adapter, connect the plug from the adapter into the power jack on the back of the scale base and then plug the power adapter into the proper electrical outlet. On models requiring 220 to 240V AC, it is the customer's responsibility to obtain the correct power adapter plug.

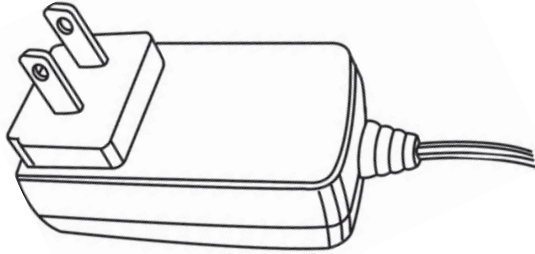

Optional PD-AC
(Medical device 9V AC/DC
Adapter, includes USA Plug)

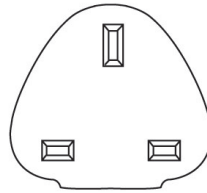

**Optional
PD-UKPLUG**
(UK Plug)

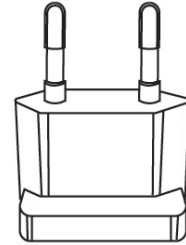

**Optional
PD-EUPLUG**
(EU Plug)

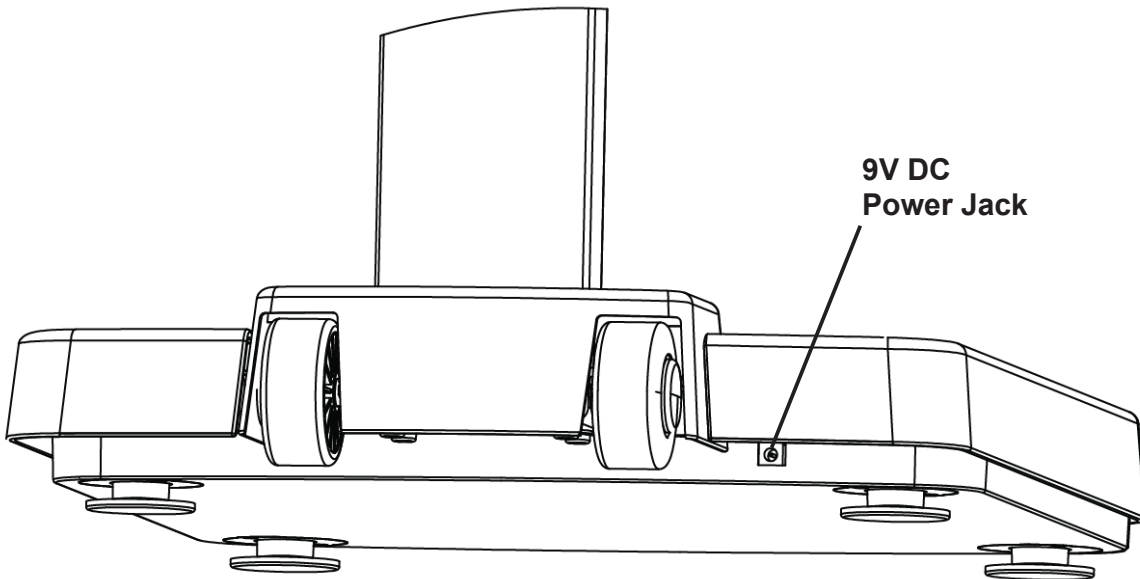

NOTE: Rear view of solo Eye-Level Physician scale shown. The power jack on the solo-RI is located in a similar position on the remote scale base.

KEYPAD FUNCTIONS



DO NOT operate the keypad with pointed objects (pencils, pens, etc.). Damage to the keypad resulting from this practice is **NOT** covered under warranty.





This is the **ON/OFF** key. Press this key to apply power to the scale and turn it on.

If the scale is already on, pressing this key will turn the scale off.



This is the **PRINT** key. It is used to send weight and associated data to a computer or other device connected to the USB port.



This is the **ENTER** key. It serves two purposes. First, when reviewing setup parameters, pressing the  key will accept the currently displayed setting of the parameter. Second, the  key is used to signal completion of the entry of data (in both setup and operation) and causes the scale to process the data entered.



This is the **ZERO** key. It is used to reset the display to zero. Note that if the zero” key is pressed with weight on the scale platform, the display will zero (tare) the weight and change to 0.0. When the weight is removed, the display will show a negative weight value and then change to 0.0.

KEYPAD FUNCTIONS, CONT.





This is the **LOCK/RELEASE** key. It is used to lock and unlock the display. Pressing this key will cause the display to lock onto the weight and remain displayed after the patient steps off the scale. Pressing the key again will unlock the display and return it to zero.

NOTE: The scale will not respond to pressing the  key unless the weight is stable, and the STA annunciator is on.



This is the **BMI** key. It is used to first input the patient's height, and then to perform the Body Mass Index (BMI) calculation. Note that the scale will not respond to pressing the key unless the weight is stable.

When using the solo height rod (or no height rod), pressing the key once allows the operator to enter the height of the patient using the  or  keys to increment or decrement to the correct height. After entering the patient's height, pressing it again will display the Body Mass Index (BMI) calculation. Pressing it a third time will return the display to the patient's weight.

NOTE: While the patient is still standing on the scale, pressing the  key will toggle between the BMI and weight display. Also, note that once the patient steps off the scale, the display automatically returns to the weight only mode.



This is the **UP ARROW** and **MOTHER/BABY** key. It is used for two purposes. When performing the Body Mass Index (BMI) calculation, it is used to increase the value for the patient's height.

When using the Mother/Baby Weighing feature, this key is used to determine the weight of infants and toddlers held by an adult. This feature allows the adult to be weighed first, and then the adult and infant/child weighed with only the weight of the infant/child displayed.



This is the **DOWN ARROW** key. It is used when performing the Body Mass Index (BMI) calculation to decrease the value for the patient's height.



NOTE: During setup and calibration, the arrow keys are used to select setup and calibration values.

ANNUNCIATORS

The annunciators are turned on to indicate that the scale display is in the mode corresponding to the annunciator label or that the status indicated by the label is active.

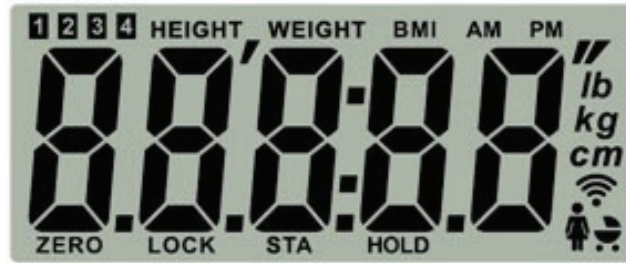



- ZERO** This annunciator is turned on to indicate the weight displayed is within +/- 1/4 division of the center of zero.
- LOCK** This annunciator is turned on to show that the scale is locked onto the displayed weight.
- STA** This annunciator is turned on when the weight on the scale is stable.
- HOLD** This annunciator is turned on to show that the display is locked onto the last stable weight.
- lb** This annunciator is turned on to indicate the displayed weight is in pounds.
- kg** This annunciator is turned on to indicate the displayed weight is in kilograms.
- cm** This annunciator is turned on when the displayed height measurement is in centimeters.
- ' "** These annunciators are turned on when the displayed height measurement is in feet and inches.
- HEIGHT** This annunciator is turned on when the scale is in the height measurement mode.
- WEIGHT** This annunciator is turned on when the scale is in the weight only mode.
- BMI** This annunciator is turned on when displaying the calculated Body Mass Index.
-  This annunciator is turned on when the scale is in the Mother/Baby Weighing mode.

OPERATION



ALWAYS assist the patient when stepping on and off the scale platform to ensure they do not fall. **NEVER** leave a patient unattended while they are on the scale platform. Failure to maintain control of the patient at all times can result in serious injury to the patient and/or you.

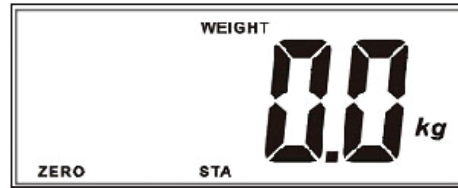
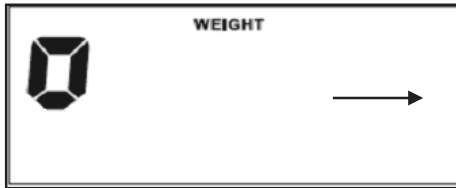

Weighing Mode

1. Press the  key. The scale will turn on, display the software version for a few seconds, and then a small  will move across the display until a stable zero is established.
2. After establishing zero, the scale will show 0.0 on display. Note that if the scale cannot establish zero, the display will show *Err0* for a few seconds and then turn the scale off.



3. Assist the patient on to the scale.
4. When the weight is stable, the weight reading will flash one time, a long beep will sound, the reading will automatically lock, and the LOCK annunciator will turn on. Note that the lock will be released once the patient steps off the scale.

NOTE: If the weight increases or decreases more than 4.4 lbs (2 kg) while the weight reading is locked, the locked weight will automatically be released, and the new weight will be locked when it is stable.

5. Press the  key to hold the current weight reading. It will remain on the display after the patient steps off the scale. Press the  key again to release the current weight reading.

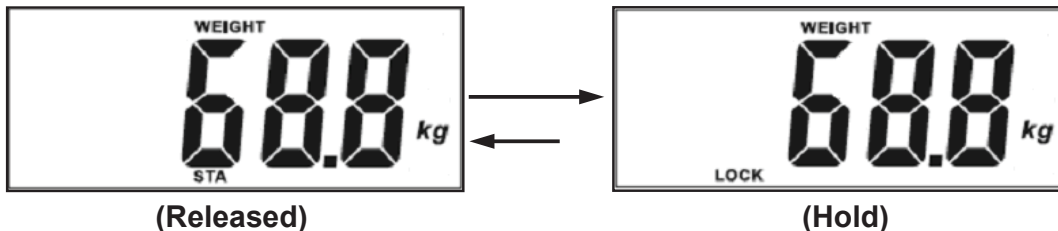

6. Assist the patient off the scale.
7. To turn the scale off, press the  key.

NOTE: If the Automatic Shutdown feature has been enabled, the scale will turn off after a pre-defined time of inactivity (no motion or weight on the scale).

OPERATION, CONT.

solo Height Rod Operation

1. Lift the headpiece on the height rod to the horizontal position.
2. Referring to the illustration to the right, lift from the end of the headpiece near the display, and raise it well above the estimated height of the patient's head.
3. Assist the patient on to the scale.
4. Carefully lower the inner height rod (press down against the height rod display cover while keeping the headpiece horizontal) until it rests on top of the patient's head.
5. If the patient is shorter than 47 in (120 cm), push the height rod display cover down flush with the display and then push the headpiece down until it rests on top of the patient's head.
6. Read the height of the patient as follows:

If the patient is shorter than 47 in (120 cm), the correct height is read at the red edge on the bottom of the headpiece.

If the patient is 47 in (120 cm) or taller, the correct height is read at the red edge on the outer column.

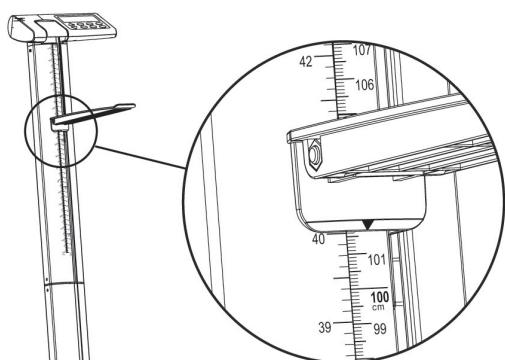
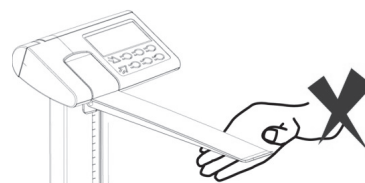
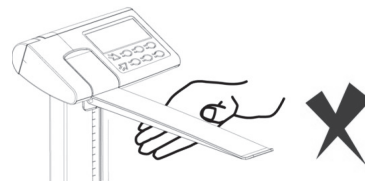
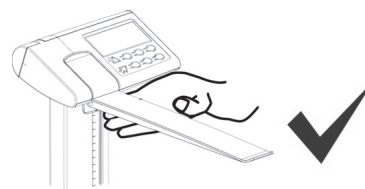

Read height at red edge on bottom of headpiece if shorter than 47" (120 cm).

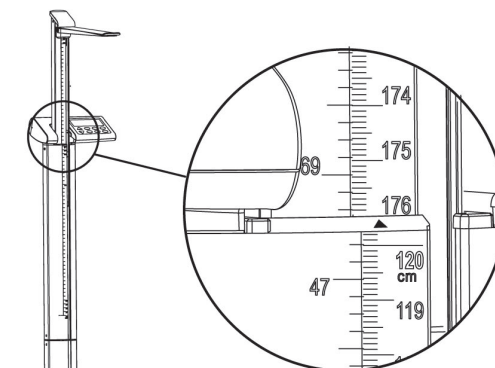





If taller than 47" (120 cm), read height at red edge on outer column.

7. Referring to the upper right illustration, lift from the end of the headpiece near the display, and raise it well above the estimated height of the patient's head.
8. Assist the patient off the scale.
9. Lower the headpiece back to the vertical position and return the height rod to the "stored" position (the headpiece should be vertical against the outer column and the height rod display cover should be flush with the display).

OPERATION, CONT.

Height and/or BMI Measure Mode

(using solo Height Rod or Previously Measured Height)







1. Assist the patient on to the scale.
2. The display will show the patient's weight.
3. Read and record the weight displayed.
4. Press the  key to enter the Height mode.
5. The scale display will show *5'00.0"* if units is pounds or *160.0 cm* if units is kilograms.
6. Press the  or  keys to increment or decrement to the correct height.
7. Press the  key. The display will change to show the BMI (Body Mass Index).
8. Read and record the patient's BMI.
9. Press the  key once more and the display will return to the patient's weight.

NOTE: While the patient is still standing on the scale, pressing the  key will toggle between the BMI and weight display.

10. Assist the patient off the scale.
11. Once the patient steps off the scale, the display will return to the weight only mode.
12. To turn the scale off, press the  key.

NOTE: If the Automatic Shutdown feature has been enabled, the scale will turn off after a pre-defined time of inactivity (no motion or weight on the scale).

Optional BMI Mode

1. Press the  key.
2. The scale will show *0.0* on display.
3. Press the  key. The display will go blank, and the BMI annunciator will turn on.
4. Assist the patient on to the scale. The patient's weight will be displayed.
5. When weight is stable and locked, the scale automatically changes to the Height mode.
6. The scale display will show *5'00.0"* if units is pounds or *160.0 cm* if units is kilograms.
7. Press the  or  keys to increment or decrement to the correct height.
8. Press the  key. The display will change to show the BMI (Body Mass Index).
9. Read and record the patient's BMI.
10. Press the  key once more and the display will return to the patient's weight.

NOTE: While the patient is still standing on the scale, pressing the  key will toggle between the BMI and weight display.

11. Assist the patient off the scale
12. Once the patient steps off the scale, the display will return to the weight only mode.
13. To turn the scale off, press the  key.

NOTE: If the Automatic Shutdown feature has been enabled, the scale will turn off after a pre-defined time of inactivity (no motion or weight on the scale).

MOTHER/BABY WEIGHING











The Mother/Baby Weighing mode can be used to determine the weight of infants and toddlers held by an adult. Note that for accurate weighing, the child should always be weighed with the same adult whose initial weight was determined. Also, the adult's weight should not change, for example, by removing or adding an item of clothing.







ALWAYS assist the mother alone, and when holding the baby in stepping on and off the scale platform to ensure they do not fall.

NEVER leave the mother or mother holding the baby unattended while they are on the scale platform. Failure to maintain control of the mother or mother holding the baby/child at all times can result in serious injury to the mother or mother holding the baby and/or you.



The Mother/Baby Weighing procedure is as follows:

1. Press the  key. The scale will turn on, display the software version for a few seconds, and then a small  will move across the display until a stable zero is established.
2. After establishing zero, the scale will show  on display.
3. Press the  key to enter the Mother/Baby weighing mode. The scale will beep, and the  annunciator will turn on.
4. Assist the mother on to the scale.
5. The display will flash the  icon several times, sound a long beep, and then lock onto the mother's weight with the LOCK annunciator on and the  icon on solid.
6. Assist the mother off the scale.
7. When the mother steps off the scale, the display will change to show " lb" with the  icon flashing which means the scale is ready to weigh the baby.
8. After the mother is holding the baby, assist them both back onto the scale.
9. The display will flash the  icon several times, sound a long beep, and then lock onto the baby's weight with the LOCK annunciator on and the  icon on solid.

NOTE: If the baby's weight is lower than 2.2 lb (1kg), the scale will display "- - -".

10. Assist the mother holding the baby off the scale.
11. The display will change to show " lb" with the  icon on.
12. To weigh another baby, repeat steps 4 through 10.
13. To turn off the Mother/Baby Weighing mode, press the  key or press the  key to turn the scale off.



NOTE: If more time is needed to read the locked weight before the patient steps off the scale, press the  key to hold the weight on the display. To release the locked weight and resume operations, press the  key again.

SCALE SETUP

Your solo Series Digital Clinical Scale has been pre-configured at the factory and should not require changes for use in most applications. However, if the factory settings do not meet the requirements of your operation, the following describes the setup process for your scale.

To Enter Setup

1. With the scale off, press and hold the $\Rightarrow 0 \Leftarrow$ key, and then press the ON key.

NOTE: If OneWeigh is enabled ($\text{ONE} = 1$), the prompt for the UNIT setting will be bypassed and the display will show the prompt for the MIN (minutes) setting. Otherwise, the display will show the prompt for the UNIT setting.

2. Release the $\Rightarrow 0 \Leftarrow$ key.
3. The scale is now ready for setup.



NOTE: When a prompt and value displayed are acceptable, press the \Leftarrow key to save the setting and proceed to the next prompt. To change a setting, press the \uparrow or \downarrow keys to adjust the setting (or select a new value) and then press the \Leftarrow key to save the new setting and advance to the next prompt.

UNIT (Weighing Unit)

The display will show UNIT and flash the annunciator (kg) or (lb) for the current unit setting. If the displayed setting is acceptable, press the \Leftarrow key to save it and proceed to the next prompt.

Otherwise, use the \uparrow or \downarrow keys to change the weighing unit and then press the \Leftarrow key to save it and proceed to the next prompt.

NOTE: Once the unit is selected, it will be kept even after the batteries are replaced.

$\text{ONE} =$ (OneWeigh)

The display will show $\text{ONE} = 0$ with the 0 blinking to indicate the OneWeigh setting is disabled. If it is desired to keep the ability to change the unit setting available, press the \Leftarrow key to save it, and proceed to the next prompt.

Otherwise, if it is desired to lock the selected unit setting permanently, press the \uparrow or \downarrow keys to select $\text{ONE} = 1$ (with the 1 blinking to indicate the OneWeigh setting is enabled), and then press the \Leftarrow key to save it and proceed to the next prompt.



OneWeigh Feature is Disabled



OneWeigh Feature is Enabled





IMPORTANT! Once the OneWeigh feature is enabled, the UNIT setting prompt will be bypassed, and setup will proceed to the next prompt, MIN : (**Minutes**).

SCALE SETUP, CONT.

mm: (Minutes)



The display will show *mm*: 00, the current Minutes setting. If the value displayed is acceptable, press the  key to save it and proceed to the next prompt.

Otherwise, press the  or  keys to select a new value from 00 to 59, and then press the  key to save it and proceed to the next prompt.

NOTE: The default minute setting is 00.

hh: (Hours)

The display will show *hh*: 00, the current Hours setting. If the value displayed is acceptable, press the  key to save it and proceed to the next prompt.



Otherwise, press the  or  keys to select a new value from 00 to 23, and then press the  key to save it and proceed to the next prompt.

IMPORTANT! Time is entered in a 24-hour format. When entering times after 12:00 PM (noon), you must add 12 to the time. For example, 3:00 PM would be entered as 15.

NOTE: The default hour setting is 00 (midnight).

yy: (Years)



The display will show *yy*: 00, the current Years setting. If the value displayed is acceptable, press the  key to save it and proceed to the next prompt.

Otherwise, press the  or  keys to select a new value from 00 to 99, and then press the  key to save it and proceed to the next prompt. Note that 00 represents the year 2000, 01 represents 2001, and so on.

NOTE: The default year setting is 00 (2000).

mm: (Months)



The display will show *mm*: 01, the current Months setting. If the value displayed is acceptable, press the  key to save it and proceed to the next prompt.

Otherwise, press the  or  keys to select a new value from 01 to 12, and then press the  key to save it and proceed to the next prompt. Note that 01 represents January, 02 represents February, and so on.

NOTE: The default month setting is 01 (January).

dd: (Day)

The display will show *dd*: 01, the current Day setting. If the value displayed is acceptable, press the  key to save it and proceed to the next prompt.



Otherwise, press the  or  keys to select a new value from 01 to 31, and then press the  key to save it and proceed to the next prompt.

NOTE: The default day setting is 01 (first day of the month).

SCALE SETUP, CONT.

ASH (Automatic Shutoff)

The display will show *ASH* _ _ , the current Automatic Shutoff setting. If the value displayed is acceptable, press the  key to save it and proceed to the next prompt.



Otherwise, press the  or  keys to select a new value, and then press the  key to save it and proceed to the next prompt.



Allowable values are 00 to 09 minutes in 1-minute increments. Note that selecting 00 disables the automatic shutoff feature. The default Automatic Shutoff setting is *ASH03* (3 minutes).

NOTE: The Automatic Shutoff function will not be active when in the calibration mode.

bu (Buzzer Setting)

During operation, if an incorrect key is pressed, the scale will sound two beeps as a warning and the operation will not be processed.

The display will show *bu*   , the current Buzzer setting. If the value displayed is acceptable, press the  key to save it. All scale setup settings (current or new values) will be saved, and the scale will automatically turn off.

Otherwise, press the  or  keys to select a new value, and then press the  key to save it. All scale setup settings (current or new values) will be saved, and the scale will automatically turn off.

Allowable values are 0 (disable) or 1 (enable).

NOTE: The default Buzzer setting is 1 (enable).

CALIBRATION

Your solo Series Digital Clinical Scale was calibrated at the factory and should not require adjustment. If the scale should need re-calibration, the following describes the calibration procedure. To maintain the instrument's high degree of accuracy, a qualified technician should perform this function.

To perform calibration, you will need either 400 pounds or 200 kilograms of certified test weights, depending on the weighing unit (kilograms or pounds) of your scale. It is recommended to use eight (8) single 50-pound or 25-kilogram test weights for calibration.



NOTE: Before starting calibration, verify that the test weights match the weighing units of the scale. If they do not match, the weighing unit setting on the scale must be changed.

Changing the Weighing Unit



IMPORTANT! If the OneWeigh feature has been enabled, the *Unit* setting cannot be accessed until the OneWeigh feature has been reset. To reset (disable) the OneWeigh feature, contact Deteco Technical Support (e-mail tech@cardet.com or call 1-866-254-8261) for the procedure to reset it.

1. To change the weighing unit, ensure OneWeigh is disabled, and then turn the scale off.
2. Press and hold the **→0←** key and then press the **⏻** key to turn the scale on.
3. The scale will enter setup mode with the display showing *Unit* and flash the **lb** or **kg** annunciator for the current setting.
4. Release all the keys.
5. Use the **↑** or **↓** keys to change the weighing unit to **lb** or **kg**, (to match your test weights) and then press the **↵** key.
6. Press the **↵** key repeatedly until the scale automatically turns off.
7. The scale is now ready to enter calibration.

To Enter Calibration

1. With the scale off, press and hold the **↵** and **→0←** keys, and then press the **⏻** key.
2. The scale will beep twice, and then the display will turn on showing *SEtCC*.
3. Release all the keys.
4. The scale is now ready to begin calibration.







NOTE: When a prompt and value displayed are acceptable, press the **↵** key to save the setting and proceed to the next prompt. To change a setting, press the **↑** or **↓** keys to adjust the setting (or select a new value) and then press the **↵** key to save the new setting and advance to the next prompt.

CALIBRATION, CONT.

SEEGC (Set Calibrated Gravity Constant)

This setting (e.g., *9787*) is the acceleration of gravity constant value for the location where the scale was calibrated.



With the display showing *SEEGC*, press the  key to show the current setting. If the value displayed is acceptable, press the  key and proceed to the next prompt.



Otherwise, press the  or  keys to adjust the setting then press the  key to save it and proceed to the next prompt.

Allowable values are 9.700 through 9.900.

EARGC (SET OPERATED GRAVITY CONSTANT)

This setting (e.g., *9813*) is the acceleration of gravity constant value for the location where the scale will be operated.

With the display showing *EARGC*, press the  key to show the current setting. If the value displayed is acceptable, press the  key and proceed to the next prompt.



Otherwise, press the  or  keys to adjust the setting then press the  key to save it and proceed to the next prompt.

Allowable values are 9.700 through 9.900.

EARn (Calibrate Scale)

Step 1. The display will change to show *EARn*.

Step 2. To skip calibration and save the previous settings, press the  key to exit the calibration mode. The scale will turn off automatically.

Step 3. Otherwise, press the  or  keys to select *Y* (Y = start calibration). Note that you can still select *n* (n = exit calibration), skip calibration, and turn the scale off.

Step 4. Press the  key to confirm.

Step 5. Make certain the scale platform is empty and free of debris.

Step 6. The display will change to show the internal count.

Step 7. Press the  key to save the zero-reference point.

Step 8. The display will change to show the first calibration point *100 kg* or *200 lb*.

Step 9. While safely applying motion to the scale platform, load the first set of test weights (equal to *100 kg* or *200 lb*) on the scale platform. When all the test weights are on the scale, stop applying motion to the scale.

Step 10. Once motion has stopped and the weight is stable (STA annunciator will turn on), the first weight reading will be saved, and the display will change to show the second calibration point *200 kg* or *400 lb*.

Step 11. Again, while safely applying motion to the scale platform, load the remaining test weights (add the remaining *100 kg* or *200 lb*) on the scale platform. When all the test weights are on the scale, stop applying motion to the scale.

Step 12. Once motion has stopped and the weight is stable (STA annunciator will turn on), the second weight reading will be saved, the display will change to show *PASS*, and the scale will automatically turn off.

DATA TRANSMISSION FORMAT

Data Transmission via USB

The USB port on the solo Series Digital Clinical Scale is a bi-directional port that can receive and transmit data. It can be used to communicate to a computer by pressing the  key, or by transmitting a command from the computer to the scale.

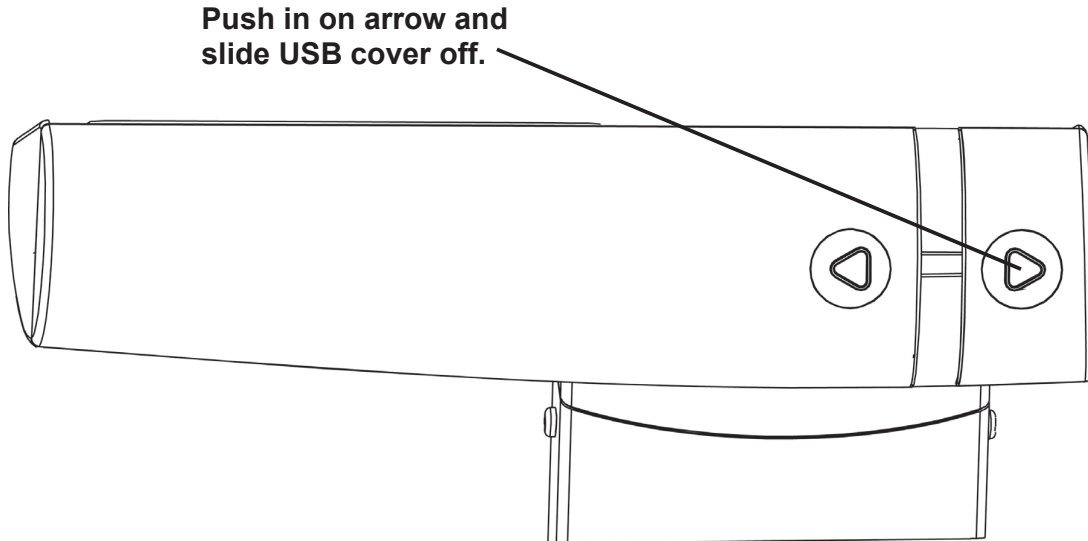

To connect to a computer or other USB device, you will need a USB Type B cable to plug into the USB port located under the small cover on the back of the display.

Output Format

The format below represents the output directly to a computer for processing of data and includes commas between each field, and a carriage return to terminate the record.

Time, Date, Mother BMI, Height, Mother Weight, Baby Weight <CR>
12:00,12/01/20,21.5,5'03.0",132.3lb,12.5lb

Remote Print Command

The host device (computer) can send the following command to get data from the scale.

<LF> P <CR>

This command is equivalent to pressing the  key. The scale will respond by sending the Output Format data (described above) to the computer.

DISPLAY MESSAGES

The solo Series Digital Clinical Scales are equipped with software that tests various portions of the scale's circuitry and verifies proper operation. Should a problem be detected, a message will be displayed alerting the operator to that condition. The following lists the messages displayed and their meaning:

DISPLAY	MEANING
<i>Err0</i>	This will be displayed for a few seconds when the scale cannot establish zero, and then turn the scale off. Refer to the TROUBLESHOOTING section.
<i>LoBAt</i>	Displayed when the batteries are near the point they need to be replaced.
<i>OCAP</i>	Weight on scale exceeds 570 lb (260 kg).

TROUBLESHOOTING

Your scale has been designed to provide you with years of trouble-free operation. Despite this, troubles sometimes happen. Before calling for service assistance you should make some initial checks to verify that a problem does exist. The following describes several types of symptoms along with suggested remedies.

PROBLEM	POSSIBLE SOLUTIONS
The display does not turn on	<p>Battery Operation:</p> <ul style="list-style-type: none"> • Check if the batteries are installed and correctly. • Are the batteries discharged? Remove the old batteries and replace them with new ones. <p>AC Operation:</p> <ul style="list-style-type: none"> • Is the 9V AC/DC power adapter fully inserted into the wall receptacle? • Check the wall receptacle for proper AC power. Try another electrical appliance in the same receptacle. Does it work? • Check the circuit breaker. • Has there been a power failure?
Incorrect weight displayed	<p>Make sure the scale platform is not touching an adjacent object.</p> <p>Have proper operation procedures been followed?</p>
The display shows <i>Err0</i> and shuts off	If the platform is not empty (the patient is on the scale) when powering up, the display will show <i>Err0</i> and turn off. Remove any weight from the platform (have the patient step off the scale) and power up the scale again. If the scale continues to show <i>Err0</i> and turns off, consult your scale service representative.
The display shows a moving small \square	<p>If the display shows a moving small \square when powering up, make sure the scale is stable and wait for a moment until the display shows $\square.\square$.</p> <p>If the scale continues to show a moving small \square, please consult your scale service representative.</p>

CARE AND CLEANING

- **DO NOT** submerge scale in water, pour or spray water directly on the display.
- **DO NOT** use acetone, thinner, or other volatile solvents for cleaning.
- **DO NOT** expose scale to temperature extremes.
- **DO NOT** place the scale in front of heating/cooling vents.
- **DO** clean the scale and display with a damp soft cloth and mild non-abrasive detergent.
- **DO** remove power before cleaning with a damp cloth.
- **DO** provide clean AC power and adequate protection against lightning damage.
- **DO** keep the surroundings clear to provide clean and adequate air circulation.

PARTS IDENTIFICATION

Scale Assembly

Item	Qty.	Part Number	Description
1	1	7100-0218	CARPET FOOT
2	1	7100-0219	FOOT
3	2	7100-0227	LEFT COVER FOR LOAD CELL
4	2	7100-0228	RIGHT COVER FOR LOAD CELL
5	1	7100-0222	COLUMN BASE COVER
6	1	7100-0221	FRICTION SLIDER
7	1	7100-0224	SLIDER ASSEMBLY FOR SPOON
8	1	7100-0223	SPOON
9	1	7100-0225	HEIGHT ROD TOP COVER
10	1	7100-0226	COLLAR FOR HEIGHT ROD
11	1	7100-0213	COVER FOR USB PORT
12	1	7100-0214	COVER FOR BATTERIES
13	1	7100-0215	BLACK MAT WITH ADHESIVE BACKING
14	1	7100-0216	PLATFORM TOP ENCLOSURE
2, 3, 15, 16, 17, 18, 19, 20, 21, 22, 35, 36	1	7100-0217	SCALE BASE BOTTOM ENCLOSURE ASSEMBLY
23	1	7100-0211	DIGITAL INDICATOR
24	1	7100-0210	KEYPAD OVERLAY
25	1	7100-0212	CABLE TO INDICATOR
26, 27, 28, 29	1	7100-0220	WHEEL KIT
30	1	7100-0229	INDICATOR MOUNTING BRACKET
31	1	7100-0254	COLUMN, UPPER SECTION
32	1	7100-0256	COLUMN, CONNECTOR
33	1	7100-0255	COLUMN, LOWER SECTION
34	2	7100-0272	PLASTIC COVER

PARTS IDENTIFICATION, CONT.

Display and Column Sub-Assembly

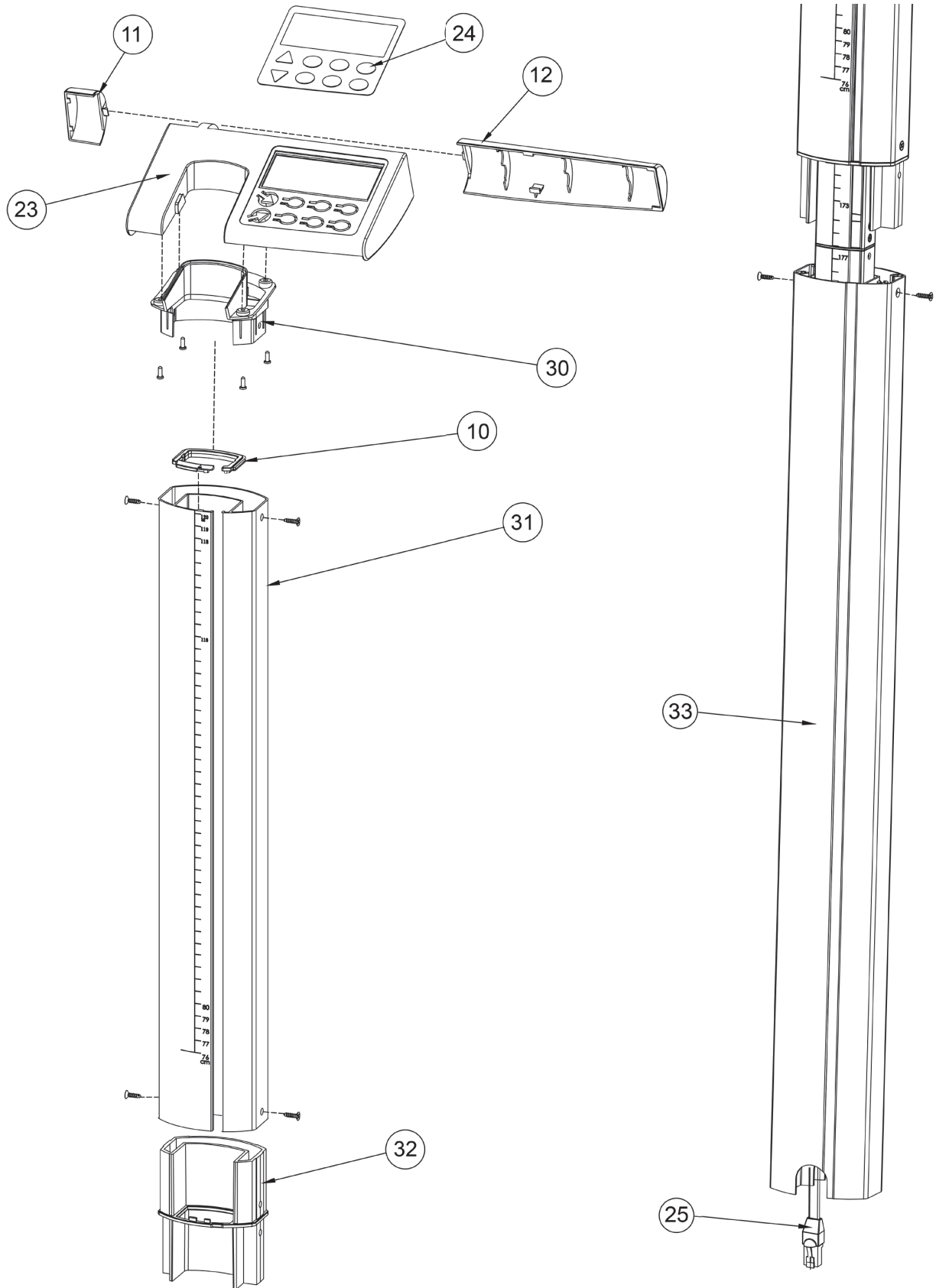

PARTS IDENTIFICATION, CONT.

Base Sub-Assembly

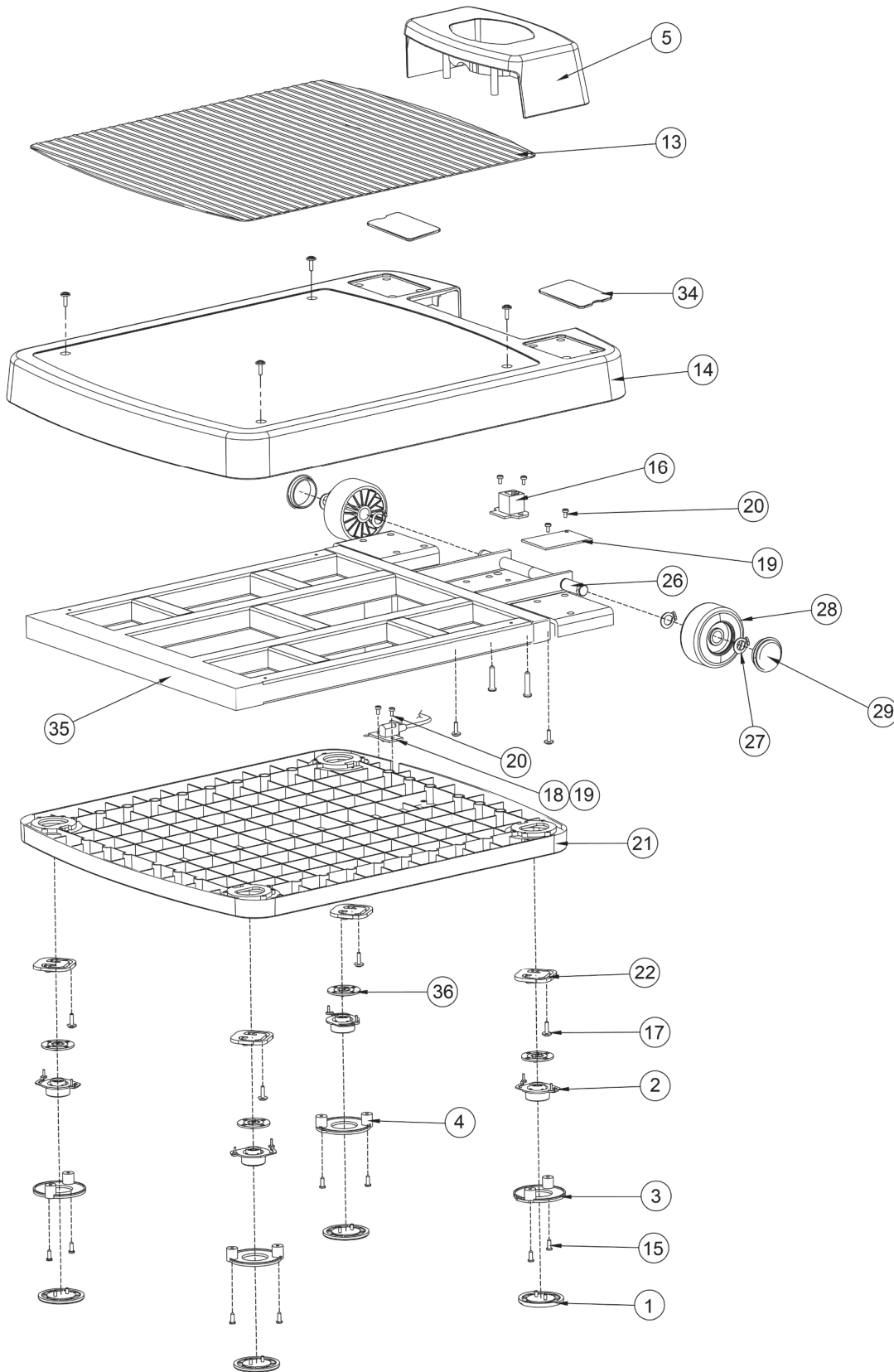

PARTS IDENTIFICATION, CONT.

Height Rod Sub-Assembly

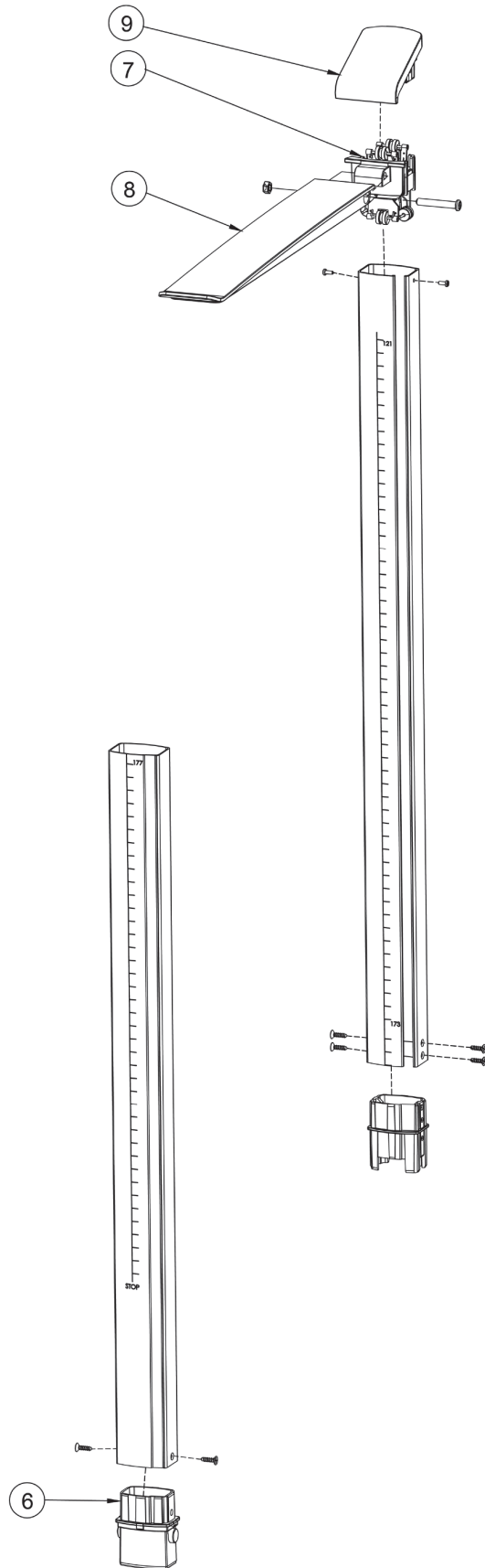

STATEMENT OF LIMITED WARRANTY

Detecto Scale warrants its equipment to be free from defects in material and workmanship as follows: Detecto warrants to the original purchaser only that it will repair or replace any part of equipment which is defective in material or workmanship for a period of two **(2) years from date of shipment**. Detecto shall be the sole judge of what constitutes a defect.

During the **first ninety (90) days** Detecto may choose to replace the product at no charge to the buyer upon inspection of the returned item.

After the first ninety (90) days, upon inspection of the returned item, Detecto will repair or replace it with a remanufactured product. The customer is responsible for paying for the freight both ways.

This warranty does not apply to peripheral equipment not manufactured by Detecto; this equipment will be covered by certain manufacturer's warranty only.

This warranty does not include replacement of expendable or consumable parts. This does not apply to any item which has deteriorated or damaged due to wear, accident, misuse, abuse, improper line voltage, overloading, theft, lightning, fire, water or acts of God, or due to extended storage or exposure while in purchaser's possession. This warranty does not apply to maintenance service. Purchased parts will have a ninety (90) day repair or replacement warranty only.

Detecto may require the suspect product to be returned to the factory; item(s) must be properly packed and shipping charges prepaid. A return authorization number must be obtained for all returns and marked on the outside of all returned packages. Detecto accepts no responsibility for loss or damage in transit.

STATEMENT OF LIMITED WARRANTY

Conditions Which Void Limited Warranty

This warranty shall not apply to equipment which:

- A.) Has been tampered with, defaced, mishandled or has had repairs and modifications not authorized by Detecto.
- B.) Has had serial number altered, defaced, or removed.
- C.) Has not been grounded according to Detecto's recommended procedure.

Freight Carrier Damage

Claims for equipment damaged in transit must be referred to the freight carrier in accordance with freight carrier regulations.

This warranty sets forth the extent of our liability for breach of any warranty or deficiency in connection with the sale or use of the product. Detecto will not be liable for consequential damages of any nature, including but not limited to, loss of profit, delays, or expenses, whether based on tort or contract. Detecto reserves the right to incorporate improvements in material and design without notice and is not obligated to incorporate improvements in equipment previously manufactured.

The foregoing is in lieu of all other warranties, express or implied including any warranty that extends beyond the description of the product including any warranty of merchantability or fitness for a particular purpose. This warranty covers only those Detecto products installed in the forty-eight (48) contiguous continental United States.



Ph. (800) 641-2008
E-mail: detecto@cardet.com
203 E. Daugherty
Webb City, MO 64870

08/27/2014
Printed in USA
D268-WARRANTY-DET-A



*Cardinal Scale Manufacturing Co.
102 E. Daugherty, Webb City, MO 64870 USA
Ph: 417-673-4631 or 1-800-641-2008
Fax: 417-673-2153*

*Technical Support: 1-866-254-8261
E-mail: tech@cardet.com*