



Science.  
Applied to Life.™

A photograph of three surgeons in an operating room. They are wearing blue scrubs, blue bouffant caps, and white surgical masks. They are focused on a patient lying on a table, which is covered with a green surgical drape. The room is brightly lit by large overhead surgical lamps. In the background, there is a monitor displaying a medical image and various pieces of medical equipment. The overall scene is professional and clinical.

# Surgical Drapes

## Drape Selection Guide

# SSIs create a human and financial cost

Occur in  
**2-5%**  
of all patients  
undergoing  
inpatient surgery<sup>1</sup>

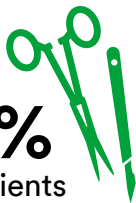

Cost on average  
**\$20,785**

per patient<sup>2</sup>



Result in  
**2-11X**  
increased risk  
of mortality<sup>1</sup>



Increase  
nursing care<sup>3</sup>



Lower  
patient  
satisfaction<sup>3</sup>



SSIs can affect a patient's quality of life and create stress for patients and their families. And they place a huge operational and financial burden on health care systems and providers. Using evidence-based practices to reduce skin microbes – before and during surgery – and creating a barrier to microbial migration can help reduce the risk of an SSI.

Fight SSIs from every angle.

## 3M™ Steri-Drape™ Absorbent Prevention Fabric

- Low-linting, nonwoven, absorbent fabric laminated to a plastic film
- Resistant to fluid strike-through
- Absorbent throughout the entire drape, eliminates the need to define a “critical zone”
- Meets Flammability Class 1 (CFR Title 16 Part 1610)

## 3M™ Ioban™ 2 Antimicrobial Incise Drape

- Designed with continuous broad-spectrum antimicrobial activity in the drape adhesive where it can't be washed away
- Clinically proven to help reduce the risk of wound contamination and immobilize bacteria on the skin<sup>4,5</sup>

## 3M™ Ioban™ 2 Antimicrobial Incise Drape Easy-Delivery (EZ)

- Polyethylene liner is designed to come off smoothly, effortlessly, with no tearing, for easier drape delivery
- Drape and liner feature a full-width handle for control of liner release and drape application

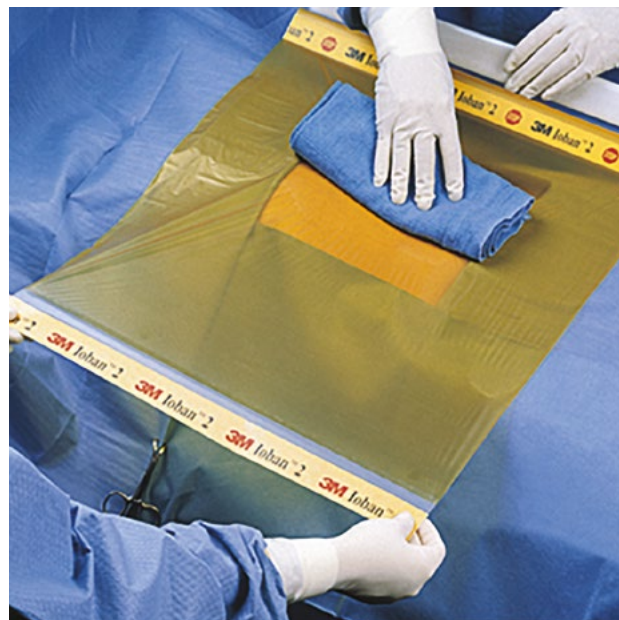

### References

1. Anderson DJ, Podgorny K, Berrios-Torres SI, et al. Strategies to prevent surgical site infections in acute care hospitals: 2014 Update. *Infect Control Hosp Epidemiol.* 2014;35(6):605–27.
2. Zimlichman E, Henderson D, Tamir O, et al. Health care-associated infections: A meta-analysis of costs and financial impact on the U.S. health care system. *JAMA Intern Med.* 2013;173:2039–46.
3. Prevention and treatment of surgical site infection. NICE Web site. <https://www.nice.org.uk/guidance/cg74/evidence/full-guideline-242005933>. Published October 2008. Accessed January 30, 2017.
4. Dewan PA, Van Rij AM, Robinson RG, Skeggs GB, Fergus M. The use of an iodophor-impregnated plastic incise drape in abdominal surgery – a controlled clinical trial. *ANZ J Surg.* 1987;57:859–63.
5. French MLV, Eitzen HE, Ritter MA. The plastic surgical adhesive drape: an evaluation of its efficacy as a microbial barrier. *Ann Surg.* 1976;184:46–50.



# DRAPE SELECTION GUIDE

	Page
Product Index by Catalog Number .....	iii-v
Six Principles of Draping .....	vi
3M™ Ioban™ 2 Antimicrobial Incise and Specialty Fabric Drapes .....	2-5
3M™ Steri-Drape™ 2 Incise Drapes .....	6-7
3M™ Steri-Drape™ Orthopaedic Drapes .....	8-15
3M™ Steri-Drape™ Cardiovascular/Cardiac Catheterization Drapes .....	16-19
3M™ Steri-Drape™ Obstetrics and Gynaecology Drapes .....	20-25
3M™ Steri-Drape™ EENT Drapes .....	26-29
3M™ Steri-Drape™ General Surgery Drapes .....	30-37
3M™ Steri-Drape™ Urology Drapes .....	38-41
3M™ Steri-Drape™ Neurology Drapes.....	42-45
3M™ Steri-Drape™ Surgical Sheets and Accessories.....	46-53
3M™ Steri-Drape™ Fluid Collection Pouches .....	54-55
3M™ Steri-Drape™ Equipment Drapes .....	56

# INDEX BY CATALOG NUMBER

Drape	Description	Page	Drape	Description	Page
1000	Disp Roll Prep Drape	49	1033 1033NS	Medium Drape with Wide Adhesive Aperture	28
1000NSR	Roll Prep Drape	49	1035 1035NS	Incise Drape	7
1000 1000NSD 1000NS	Small Towel Drape	49	1040 1040NS	Incise Drape	7
1003 1003NS	Isolation Bag	36, 52	1050 1050NS	Incise Drape	7
1007	Arthroscopy Fluid Collection Pouch	15	1051 1051NS	Incise Drape	7
1010 91010SD 1010NS	Large Towel Drape	49	1055B 1055NS	Large Ophthalmic Sheet with Incise Film and Pouches	29
1012 1012NS	Fluoroscope Drape	56	1060 1060NS	Medium Drape with Incise Film	28
1013 1013NS	C-arm Drape	56	1061 1061NS	Medium Drape with Incise Film and Pouch	28
1014 1014NS	Patient Isolation Drape	10	1062 1062NS	Ophthalmic Incise Drape with Pouch	29
1015 1015NSD 1015NS	U-drape	14, 44, 46	1064 1064NS	Ophthalmic Sheet with Aperture and Pouches	29
1016 1016NS	Irrigation Pouch	15, 24, 37, 41, 45, 54	1065B 1065NS	Large Ophthalmic Sheet with Aperture and Pouches	29
1017	Isolation Drape with Incise Film and Pouch	11	1067 1067NS	U-pouch	15, 45, 55
1018 1018NS	Instrument Pouch	52	1071 1071NS	Urological Drape	41
1018L 1018LNS	Long Instrument Pouch	52	1072 1072NS	Aperture Pouch Drape	25, 37, 41, 54
1019 1019NS	Long U-drape	14, 45, 46	1073	Wound Edge Protector	36, 52
1020 1020NS	Small Drape with Adhesive Aperture	26, 47	1074	Wound Edge Protector	36, 52
1021 1021NS	Small Drape with Incise Sheet	26, 47	1075	Wound Edge Protector	36, 52
1022 1022NS	Refractive Drape	27	1076	Wound Edge Protector	36, 52
1023 1023NS	Small Drape with Incise Film and Pouch	27	1077	Wound Edge Protector	36, 52
1024 1024NS	Small Drape with Adhesive Aperture and Pouch	27, 54	1080 1080NS	Gynecology Drape	21, 40
1027 1027NS	Irrigation Pouch	54	1081 1081NS	TUR/Urological Drape	40
1030 1030NS	Medium Drape with Adhesive Aperture	28, 47	1083 1083NS	Perineal/Leg Sheet	18
1031 1031NS	Laparoscopic Drape/Supine Position	21, 32, 39	1084 1084NS	Under Buttocks Drape with Pouch	25, 37, 41, 54
1032 1032NS	Laparoscopic Drape/Lithotomy Position	21, 32, 39	1089 1089NS	Utility Sheet (2)	51
			1090 1090NS	Femoral Angiography Drape	17

Drape	Description	Page
1092 1092NS	Small Drape with Adhesive Aperture	48
1094 1094NS	Arthroscopy Sheet with Pouch	13
1095	Arthroscopy Pack	8
1115	Tube Organizer	53
1135	PICC Drape with Adhesive Aperture	47
1191	Femoral Angiography Drape	17
1192	Venous/Arterial Access Drape	17
1194 1194NS	Arthroscopy Sheet with Pouch	13
1195	Arthroscopy Pack	8
2035 2035NS	Incise Drape	6
2037 2037NS	Incise Drape	6
2040 2040NS	Incise Drape	6
2045 2045NS	Incise Drape	6
2050 2050NS	Incise Drape	6
2051 2051NS	Incise Drape	6
2057 2057NS	Incise Pouch	24, 35, 55
2058 2058NS	Aperture Pouch Drape	24, 35, 55
2065 2065NS	Abdominoperineal Incise Drape	21, 32, 39
6617	Isolation Drape with loban 2 Incise Film and Pouch	2, 11
6619	Large Isolation Drape with loban 2 Incise Film and Pouch	2, 11
6635	loban 2 Antimicrobial Incise Drape	2
6640	loban 2 Antimicrobial Incise Drape	2
6640EZ 6640EZSB	loban 2 Antimicrobial Incise Drape	2
6648	loban 2 Antimicrobial Incise Drape	2
6648EZ 6648EZSB	loban 2 Antimicrobial Incise Drape	2
6650	loban 2 Antimicrobial Incise Drape	3
6650EZ 6650EZSB	loban 2 Antimicrobial Incise Drape	3

Drape	Description	Page
6651	loban 2 Antimicrobial Incise Drape	3
6651EZ 6651EZSB	loban 2 Antimicrobial Incise Drape	3
6657	Pouch with loban 2 Incise Film	3, 24, 35, 55
6658	Pouch with loban 2 Incise Film, Large	3, 35, 55
6659	Pouch with loban 2 Incise Film, Extra Large	35, 55
6661EZ 6661EZSB	loban 2 Antimicrobial Incise Drape	3
6665	Abdominal-Perineal Drape with loban 2 Incise Film - Lithotomy Position	4, 22, 32, 39
6677	Cardiovascular Sheet with loban 2 Incise Film	4, 18
6678	Cardiovascular Pack	4, 18
6681	Cardiovascular Drape with loban 2 Incise Film	5, 19
6682	Cardio/Chest Drape with loban 2 Incise Film	5
6687	Craniotomy Drape with loban 2 Incise Pouch	5, 44
6697	Cesarean Section Sheet with loban 2 Incise Pouch	5, 23
6697CA	Cesarean-Section Drape with loban 2 Incise Pouch, Clear Anesthesia Screen	23
7965 7965NS	Cesarean Section Drape with Incise Sheet with Pouch	23
7966 7966NS	Cesarean Section Sheet with Aperture Pouch	23
9000A	Basic Surgical Pack	8, 16, 20, 30, 38, 42
9000LA	Basic Surgical Pack	8, 16, 20, 30, 38, 42
9002	Orthopaedic Pack without Mayo Stand Cover	9
9003	Cystoscopy Pack	20, 30, 38
9007A	ENT Pack	26
9008A	Head and Neck Pack	26
9010	Basic Surgical Pack without Mayo Stand Cover	9, 16, 20, 31, 38, 42
9012A	Orthopaedic Pack without Mayo Stand Cover	9
9012LA	Orthopaedic Pack	10
9014A	Extremity Pack	10
9018A	Surgical Split Sheet Pack	31, 43
9020A	Basic Set Up Pack	20, 26, 31, 38
9021A	Orthopaedic Set Up Pack	10

# INDEX BY CATALOG NUMBER

Drape	Description	Page	Drape	Description	Page
9022A	Cardiovascular Set Up Pack	17	9056 9056NS	Bilateral Foot Drape	12, 34
9026 9026NS	Aperture Drape	48	9062 9062NS	Laparotomy Drape (Transverse)	22, 33, 40
9029 9029NS	Adhesive Aperture Drape	48	9063 9063NS	Laparotomy Drape	22, 33, 40
9030	Adhesive Aperture Drape	48	9069 9069NS	Drape Sheet	51
9030NS	Adhesive Aperture Drape	48	9072 9072NS	Back Table Cover	51
9031	Adhesive Aperture Drape	48	9077 9077NS	Back Table Cover	51
9031NS	Adhesive Aperture Drape	48	9079 9079NS	Back Table Cover	51
9036 9036NS	Mayo Stand Cover	52	9084 9084NS	Adhesive Towel Drape	49
9040 9040NS	Leggings (2)	25, 41, 53	9085 9085NS	Adhesive Towel Drape	49
9041NS	Extremity Cover	15, 53	9086 9086NS	Adhesive Towel Drape	50
9042NS	Extremity Cover	15, 53	9087 9087NS	Adhesive Drape Sheets	50
9043	Adhesive Split Sheet	14, 44, 46	9088 9088NS	Adhesive Drape Sheets	50
9043	Extremity Cover	15, 53	9090 9090NS	Adhesive Drape Sheets	50
9043NS	Adhesive Split Sheet	14, 44, 46	9095	Absorbent Pad	53
9044	Adhesive Split Sheet	14, 15, 44, 46	9097 9097NS	Instrument Pouch (L)	52
9044NS	Adhesive Split Sheet	14, 44, 46	9099 9099NS	Operation Tape	53
9044	Extremity Cover	15, 53	9196, 9196NS	Shoulder Split Sheet with Pouch	13
9045	Adhesive Split Sheet	14, 44, 46			
9045NS	Adhesive Split Sheet	14, 44, 46			
9046 9046NS	Bilateral Adhesive Split Sheet	14, 19			
9047 9047NS	Neuro Split Sheet with Pouch	43			
9048 9048NS	Adhesive Split Sheet	43, 47			
9050 9050NS	Adhesive Aperture Drape	33, 48			
9051 9051NS	Thyroid Drape	34			
9052 9052NS	Hand Drape	11, 34			
9053 9053NS	Extremity Drape	12			
9054 9054NS	Hand and Foot Drape	12, 34			
9055 9055NS	Hip Drape with Pouches	13			

# 3M™ SURGICAL DRAPES

A line of drapes designed with the six principles of draping in mind

Whether a surgery is performed in a traditional operating room, an ambulatory surgery center or a physician's office, you can be sure of one thing: one or more surgical drapes will be used. And every drape used during that procedure will address one or more of the six basic draping objectives or "principles." 3M offers many single-use, disposable surgical drapes to help meet these principles:



## 1. Isolation

Isolating dirty, contaminated areas from clean areas.



## 2. Barrier

Preventing fluid penetration.



## 3. Sterile Field

Creating a sterile operative environment by aseptic application of sterile materials.

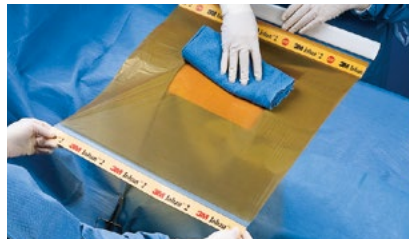

## 4. Sterile Surface

Creating a sterile surface on the skin which acts as a barrier to help prevent skin flora from migrating to the incision site.

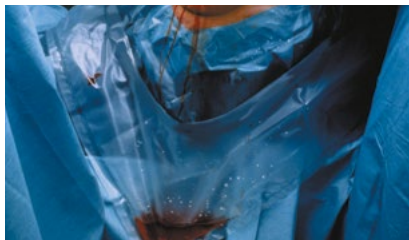

## 5. Fluid Control

Channeling and collecting body and irrigation fluids.



## 6. Equipment Draping

Allowing non-sterile equipment to be brought into the sterile field.

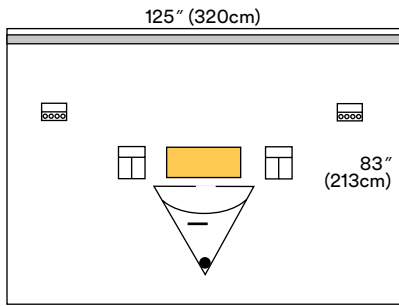

### 6617 Isolation Drape with Ioban™ 2 Incise Film and Pouch

Overall Size	Drapes/Box	Boxes/Case
125" x 83" (320cm x 213cm)	5	4

- Ioban 2 antimicrobial incise area: 19" x 9.37" (50cm x 24cm)
- Fluid collection pouch with screen
- 1 – Exit port
- 2 – Instrument pouches
- 2 – Tube and cord organizers
- Adhesive strip along top

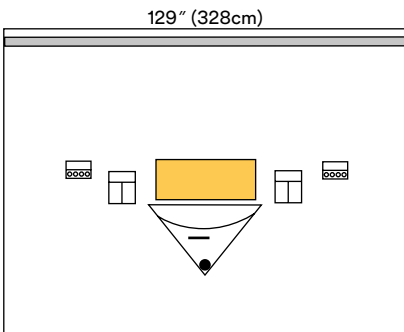

### 6619 Large Isolation Drape with Ioban 2 Incise Film and Pouch

Overall Size	Drapes/Box	Box/Case
129" x 100" (328cm x 254cm)	5	1

- Ioban 2 antimicrobial incise area: 27" x 12" (70cm x 32cm)
- Fluid collection pouch with screen
- 1 – Exit port
- 2 – Instrument pouches
- 2 – Tube and cord organizers

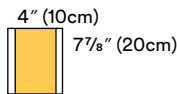

### 6635 Ioban 2 Antimicrobial Incise Drape

Incise Area	Drapes/Box	Boxes/Case
4" x 8" (10cm x 20cm)	10	4

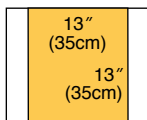

### 6640EZ\* Ioban 2 Antimicrobial Incise Drape

Incise Area	Drapes/Box	Boxes/Case
13" x 13" (35cm x 35cm)	10	4

**6640EZSB** (Sterile Bulk) *Custom Packs Only*

10 ea/cs

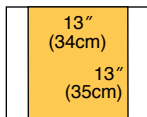

### 6640\*\* Ioban 2 Antimicrobial Incise Drape

Incise Area	Drapes/Box	Boxes/Case
13" x 13" (34cm x 35cm)	10	4

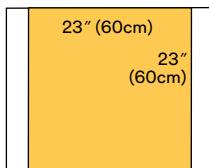

### 6648EZ\* Ioban 2 Antimicrobial Incise Drape

Incise Area	Drapes/Box	Boxes/Case
23" x 23" (60cm x 60cm)	10	4

**6648EZSB** (Sterile Bulk) *Custom Packs Only*

75 ea/cs

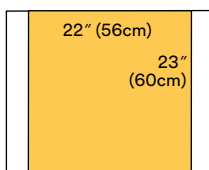

### 6648\*\* Ioban 2 Antimicrobial Incise Drape

Incise Area	Drapes/Box	Boxes/Case
22" x 23" (56cm x 60cm)	10	4



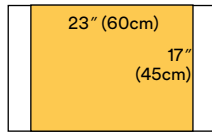

### 6650EZ\* Ioban 2 Antimicrobial Incise Drape

Incise Area	Drapes/Box	Boxes/Case
23" x 17" (60cm x 45cm)	10	4
<b>6650EZSB</b> (Sterile Bulk) <i>Custom Packs Only</i>	10 ea/cs	

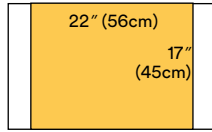

### 6650\*\* Ioban 2 Antimicrobial Incise Drape

Incise Area	Drapes/Box	Boxes/Case
22" x 17" (56cm x 45cm)	10	4

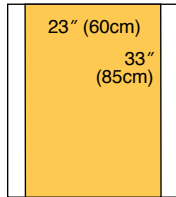

### 6651EZ\* Ioban 2 Antimicrobial Incise Drape

Incise Area	Drapes/Box	Boxes/Case
23" x 33" (60cm x 85cm)	10	4
<b>6651EZSB</b> (Sterile Bulk) <i>Custom Packs Only</i>	50 ea/cs	

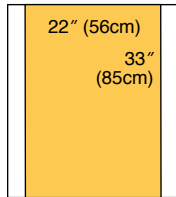

### 6651\*\* Ioban 2 Antimicrobial Incise Drape

Incise Area	Drapes/Box	Boxes/Case
22" x 33" (56cm x 85cm)	10	4

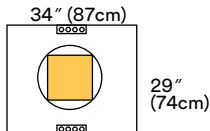

### 6657 Pouch with Ioban 2 Incise Film

Overall Size	Drapes/Box	Boxes/Case
34" x 29" (87cm x 74cm)	10	4
<ul style="list-style-type: none"> <li>Ioban 2 antimicrobial incise area: 11" x 11" (30cm x 30cm)</li> <li>360-degree fluid collection pouch</li> <li>Tube and cord organizers</li> </ul>		

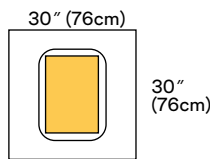

### 6658 Pouch with Ioban 2 Incise Film, Large

Overall Size	Drapes/Box	Boxes/Case
30" x 30" (76cm x 76cm)	5	4
<ul style="list-style-type: none"> <li>Ioban 2 antimicrobial incise area: 13" x 17" (33cm x 43cm)</li> <li>360-degree fluid collection pouch</li> </ul>		

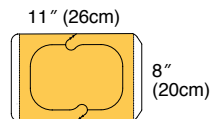

### 6661EZ\* Ioban 2 Antimicrobial Incise Drape

Incise Area	Drapes/Box	Boxes/Case
11" x 8" (26cm x 20cm)	50	4
<b>6661EZSB</b> (Sterile Bulk) <i>Custom Packs Only</i>	400 ea/cs	

\*Denotes Ioban 2 drapes with easy-delivery features. Available in the U.S. and limited markets outside the U.S.

\*\*Available outside the U.S. only

### Easy-delivery (products denoted with EZ) features include:

- Polyethylene liner comes off smoothly, effortlessly, with no tearing, for easier drape delivery
- Drape and liner feature a full-width handle for control of liner release and drape application
- Strip at one end imprinted with stop signs indicates when the end of the drape is near



# ANTIMICROBIAL INCISE AND SPECIALTY FABRIC DRAPES



## 6665 Abdominal-Perineal Drape with Ioban 2 Incise Film – Lithotomy Position

Overall Size	Drapes/Box	Boxes/Case
78" x 107" (200cm x 274cm)	5	1

- Ioban 2 antimicrobial incise area: 13" x 17" (33cm x 45cm)
- Peri/vag. aperture: 4<sup>5</sup>/<sub>8</sub>" x 6" (12cm x 15.5cm)
- Tube and cord organizers (ref.1115)

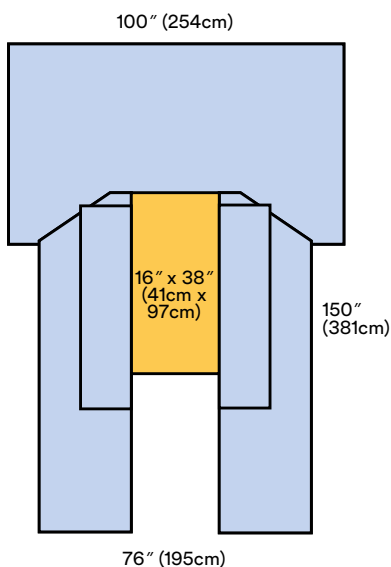

## 6677 Cardiovascular Sheet with Ioban 2 Incise Film

Overall Size	Drapes/Box	Boxes/Case
100" x 150" (254cm x 381cm)	6	1

- Ioban 2 antimicrobial incise area: 16" x 38" (41cm x 97cm)
- Dual side pockets
- Reinforced anesthesia screen

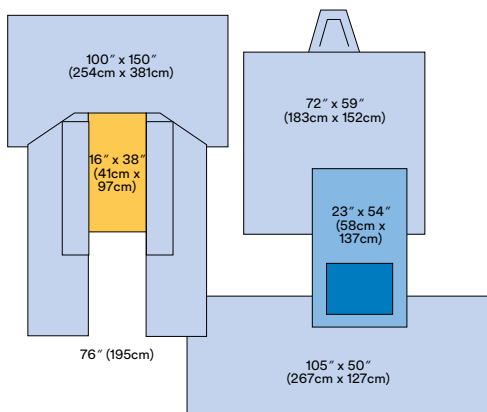

## 6678 Cardiovascular Pack

Name	Quantity	Overall Size	Packs/Box	Boxes/Case
<b>6678 Cardiovascular Pack</b>				
6677 Steri-Drape Cardiovascular Sheet with Ioban 2 Incise Film	1	100" x 150" (254cm x 381cm)	4	1
1083 Perineal/Leg Sheet	1	72" x 59" (183cm x 152cm)		
9036 Mayo Stand Cover	1	23" x 54" (58cm x 137cm)		
Back Table Cover	1	105" x 50" (267cm x 127cm)		

### KEY

Absorbent Prevention Fabric	Standard Blue Fabric (fluid-repellent)	Clear plastic film	3M™ Ioban™ 2 Antimicrobial Incise Film	3M™ Steri-Drape™ 2 Incise Film	Adhesive area

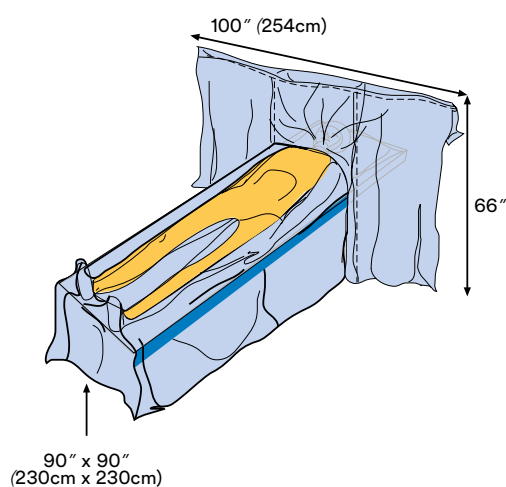

### 6681 Cardiovascular Drape with loban 2 Incise Film

Overall Size	Drapes/Box	Box/Case
100" x 151" (254cm x 384cm)	8	1

- loban 2 antimicrobial incise area: 16" x 61" (41cm x 154cm)
- One-piece design
- Expansion pleat between legs
- Blue anesthesia screen
- loban 2 antimicrobial incise film in both chest and leg areas

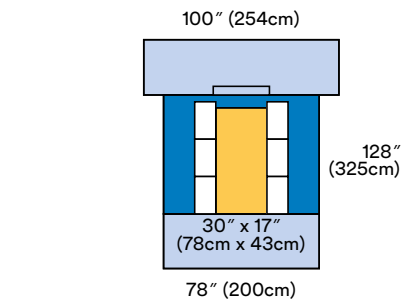

### 6682 Cardio/Chest Drape with loban 2 Incise Film

Overall Size	Drapes/Box	Boxes/Case
78" x 128" (200cm x 325cm)	8	1

- loban 2 antimicrobial incise area: 30" x 17" (78cm x 43cm)
- One-piece design
- Extended width for arm coverage
- Reinforced anesthesia screen with cord organizer
- Divided bilateral side pockets for instruments

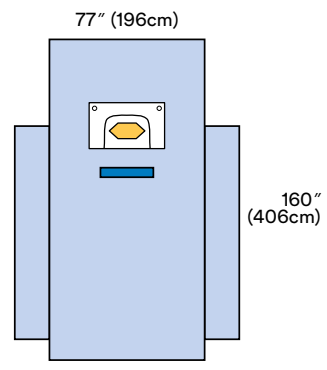

### 6687 Craniotomy Drape with loban 2 Incise Pouch

Overall Size	Drapes/Box	Boxes/Case
77" x 160" (196cm x 406cm)	10	1

- Incise area: 15" x 8" (36.8cm x 21.4cm)
- Large rectangular fluid collection pouch
- Reinforced plastic strip with a wide adhesive secural

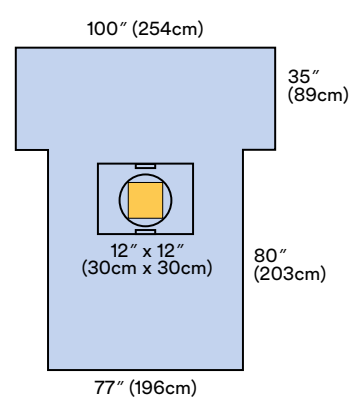

### 6697 Cesarean Section Sheet with loban 2 Incise Pouch

Overall Size	Drapes/Box	Box/Case
100" x 115" (254cm x 292cm)	5	1

- loban 2 antimicrobial incise area: 12" x 12" (30cm x 30cm)
- 360-degree fluid collection pouch
- Tube and cord organizers

<b>Absorbent Prevention Fabric</b>	<b>Standard Blue Fabric (fluid-repellent)</b>	<b>Clear plastic film</b>	<b>3M™ Ioban™ 2 Antimicrobial Incise Film</b>	<b>3M™ Steri-Drape™ 2 Incise Film</b>	<b>Adhesive area</b>



# 3M™ Steri-Drape™ 2 INCISE DRAPES

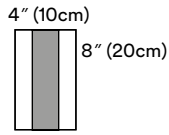

## 2035 Incise Drape

Incise Area	Drapes/Box	Boxes/Case
4" x 8" (10cm x 20cm)	10	4
<b>2035NS</b> (non-sterile) <i>Custom Packs Only</i>	200 ea/cs	

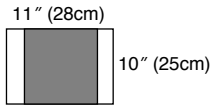

## 2037 Incise Drape

Incise Area	Drapes/Box	Boxes/Case
11" x 10" (28cm x 25cm)	10	4
<b>2037NS</b> (non-sterile) <i>Custom Packs Only</i>	200 ea/cs	

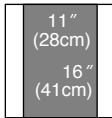

## 2040 Incise Drape

Incise Area	Drapes/Box	Boxes/Case
11" x 16" (28cm x 41cm)	10	4
<b>2040NS</b> (non-sterile) <i>Custom Packs Only</i>	200 ea/cs	



## 2045 Incise Drape

Incise Area	Drapes/Box	Boxes/Case
19" x 17" (50cm x 45cm)	10	4
<b>2045NS</b> (non-sterile) <i>Custom Packs Only</i>	200 ea/cs	

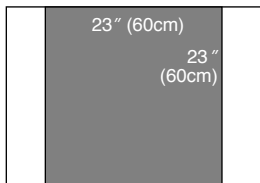

## 2050 Incise Drape

Incise Area	Drapes/Box	Boxes/Case
23" x 23" (60cm x 60cm)	10	4
<b>2050NS</b> (non-sterile) <i>Custom Packs Only</i>	200 ea/cs	

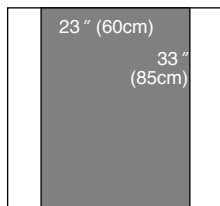

## 2051 Incise Drape

Incise Area	Drape/Box	Boxes/Case
23" x 33" (60cm x 85cm)	10	4
<b>2051NS</b> (non-sterile) <i>Custom Packs Only</i>	150 ea/cs	

### KEY





# 3M™ Steri-Drape™ 2 INCISE DRAPES

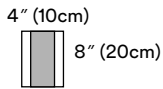

## 1035 Incise Drape

Incise Area	Drapes/Box	Boxes/Case
4" x 8" (10cm x 20cm)	10	4
<b>1035NS</b> (non-sterile) <i>Custom Packs Only</i>	200 ea/cs	

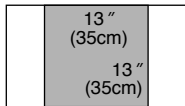

## 1040 Incise Drape

Incise Area	Drapes/Box	Boxes/Case
13" x 13" (35cm x 35cm)	10	4
<b>1040NS</b> (non-sterile) <i>Custom Packs Only</i>	200 ea/cs	

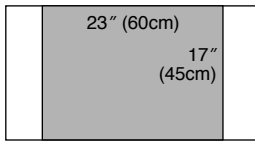

## 1050 Incise Drape

Incise Area	Drapes/Box	Boxes/Case
23" x 17" (60cm x 45cm)	10	4
<b>1050NS</b> (non-sterile) <i>Custom Packs Only</i>	200 ea/cs	

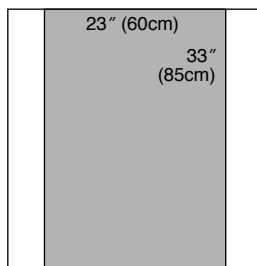

## 1051 Incise Drape

Incise Area	Drapes/Box	Boxes/Case
23" x 33" (60cm x 85cm)	10	4
<b>1051NS</b> (non-sterile) <i>Custom Packs Only</i>	150 ea/cs	

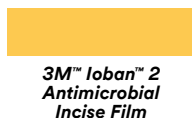

# 3M™ Steri-Drape™ ORTHOPAEDIC DRAPES

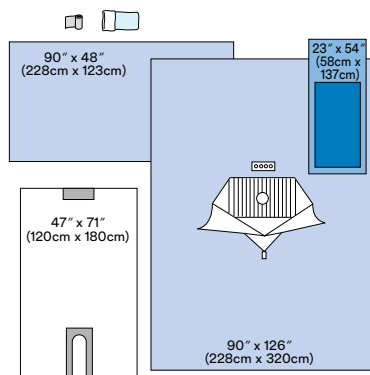

## 1095 Arthroscopy Pack

Name	Quantity	Overall Size	Packs/Box	Boxes/Case
<b>1095 Arthroscopy Pack</b>				
1094 Arthroscopy Sheet with Pouch	1	90" x 126" (228cm x 320cm)	5	1
1019 Long U-drape	1	47" x 71" (120cm x 180cm)		
Stockinette	1	9" x 30" (22cm x 76cm)		
3M™ Coban™ Self-Adherent Wrap	1	4"		
9036 Mayo Stand Cover	1	23" x 54" (58cm x 137cm)		
Back Table Cover	1	90" x 48" (228cm x 123cm)		
1095NS (non-sterile) Custom Packs Only			10 ea/cs	

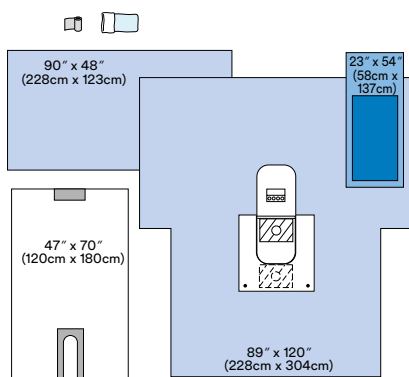

## 1195 Arthroscopy Pack

Name	Quantity	Overall Size	Packs/Box	Boxes/Case
<b>1195 Arthroscopy Pack</b>				
1194 Arthroscopy Sheet with Pouch	1	115" x 120" (292cm x 304cm)	5	1
1019 Long U-drape	1	47" x 71" (120cm x 180cm)		
Stockinette	1			
3M™ Coban™ Self-Adherent Wrap	1	4"		
9036 Mayo Stand Cover	1	23" x 54" (58cm x 137cm)		
Back Table Cover	1	90" x 48" (228cm x 123cm)		
1195NS (Custom Packs Only)			10 ea/cs	

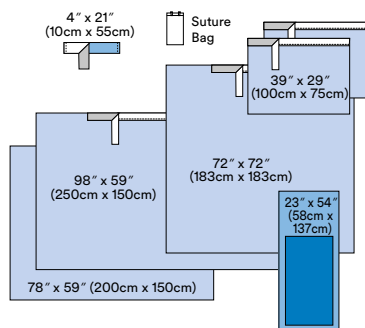

## 9000A Basic Surgical Pack

Name	Quantity	Overall Size	Packs/Box	Boxes/Case
<b>9000A Basic Surgical Pack</b>				
Suture Bag	1		7	2
9099 Operation Tape	1	4" x 21" (10cm x 55cm)		
9036 Mayo Stand Cover	1	23" x 54" (58cm x 137cm)		
9086 Adhesive Towel Drapes	2	39" x 30" (100cm x 76cm)		
9087 Adhesive Drape Sheet (M)	1	72" x 72" (183cm x 183cm)		
9088 Adhesive Drape Sheet (L)	1	98" x 59" (250cm x 150cm)		
9077 Back Table Cover	1	78" x 59" (200cm x 150cm)		

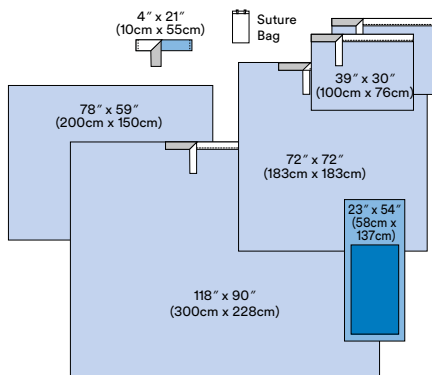

## 9000LA Basic Surgical Pack

Name	Quantity	Overall Size	Packs/Box	Boxes/Case
<b>9000LA Basic Surgical Pack</b>				
Suture Bag	1		5	2
9099 Operation Tape	1	4" x 21" (10cm x 55cm)		
9036 Mayo Stand Cover	1	23" x 54" (58cm x 137cm)		
9086 Adhesive Towel Drapes	2	39" x 30" (100cm x 76cm)		
9087 Adhesive Drape Sheet (M)	1	72" x 72" (183cm x 183cm)		
9090 Adhesive Drape Sheet (XL)	1	118" x 90" (300cm x 228cm)		
Back Table Cover	1	78" x 59" (200cm x 150cm)		

### KEY

Absorbent Prevention Fabric	Standard Blue Fabric (fluid-repellent)	Clear plastic film	3M™ Ioban™ 2 Antimicrobial Incise Film	3M™ Steri-Drape™ 2 Incise Film	Adhesive area

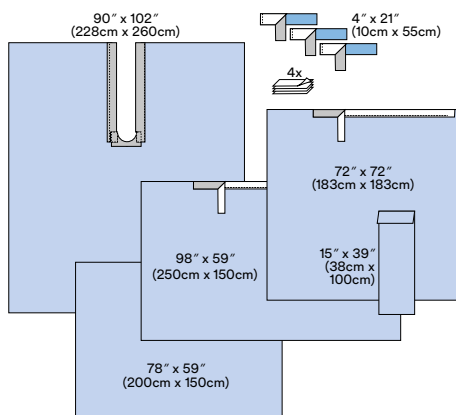

### 9002 Orthopaedic Pack without Mayo Stand Cover

Name	Quantity	Overall Size	Packs/Box	Boxes/Case
<b>9002 Orthopaedic Pack without Mayo Stand Cover</b>			5	2
9099 Operation Tapes	3	4" x 21" (10cm x 55cm)		
Hand Towels	4	-		
9042 Extremity Cover	1	15" x 39" (38cm x 100cm)		
9087 Adhesive Drape Sheet (M)	1	72" x 72" (183cm x 183cm)		
9045 Adhesive Split Sheet	1	90" x 102" (228cm x 260cm)		
9088 Adhesive Drape Sheet (L)	1	98" x 59" (250cm x 150cm)		
9077 Back Table Cover	1	78" x 59" (200cm x 150cm)		

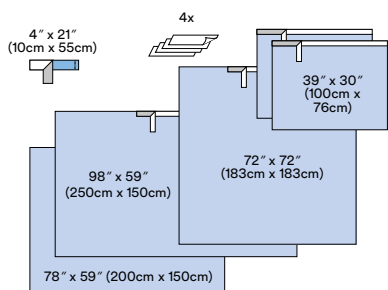

### 9010 Basic Surgical Pack without Mayo Stand Cover

Name	Quantity	Overall Size	Packs/Box	Boxes/Case
<b>9010 Basic Surgical Pack without Mayo Stand Cover</b>			7	2
9099 Operation Tape	1	4" x 21" (10cm x 55cm)		
Hand Towels	4	-		
9085 Adhesive Towel Drapes	2	39" x 33" (100cm x 85cm)		
9087 Adhesive Drape Sheet (M)	1	72" x 72" (183cm x 183cm)		
9088 Adhesive Drape Sheet (L)	1	98" x 59" (250cm x 150cm)		
9077 Back Table Cover	1	78" x 59" (200cm x 150cm)		

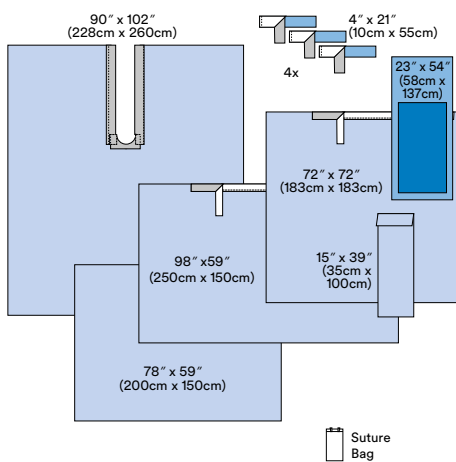

### 9012A Orthopaedic Pack

Name	Quantity	Overall Size	Packs/Box	Boxes/Case
<b>9012A Orthopaedic Pack</b>			5	2
Suture Bag	1			
9099 Operation Tape	1	4" x 21" (10cm x 55cm)		
9036 Mayo Stand Cover	1	23" x 54" (58cm x 137cm)		
9042 Extremity Cover	1	15" x 39" (38cm x 100cm)		
9087 Adhesive Drape Sheet (M)	1	72" x 72" (183cm x 183cm)		
9045 Adhesive Split Sheet	1	90" x 102" (228cm x 260cm)		
9088 Adhesive Drape Sheet (L)	1	98" x 59" (250cm x 150cm)		
9077 Back Table Cover	1	78" x 59" (200cm x 150cm)		

<b>Absorbent Prevention Fabric</b>	<b>Standard Blue Fabric (fluid-repellent)</b>	<b>Clear plastic film</b>	<b>3M™ Ioban™ 2 Antimicrobial Incise Film</b>	<b>3M™ Steri-Drape™ 2 Incise Film</b>	<b>Adhesive area</b>

# 3M™ Steri-Drape™ ORTHOPAEDIC DRAPES

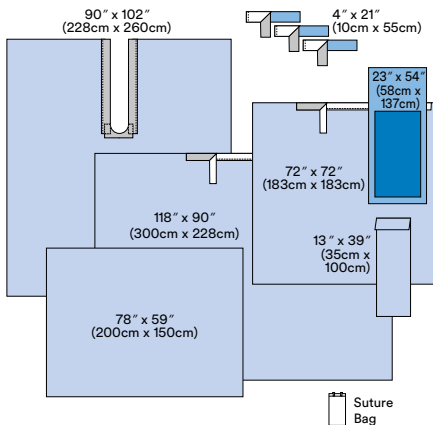

## 9012LA Orthopaedic Pack

Name	Quantity	Overall Size	Packs/Box	Boxes/Case
<b>9012LA Orthopaedic Pack</b>				
Suture Bag	1		4	2
9099 Operation Tapes	3	4" x 21" (10cm x 55cm)		
9036 Mayo Stand Cover	1	23" x 54" (58cm x 137cm)		
9042 Extremity Cover	1	15" x 39" (38cm x 100cm)		
9087 Adhesive Drape Sheet (M)	1	72" x 72" (183cm x 183cm)		
9045 Adhesive Split Sheet	1	90" x 102" (228cm x 260cm)		
9090 Adhesive Drape Sheet (XL)	1	118" x 90" (300cm x 228cm)		
9077 Back Table Cover	1	78" x 59" (200cm x 150cm)		

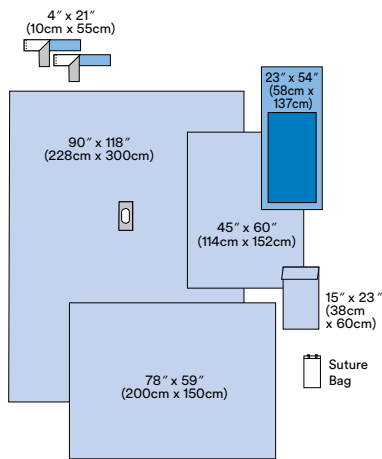

## 9014A Extremity Pack

Name	Quantity	Overall Size	Packs/Box	Boxes/Case
<b>9014A Extremity Pack</b>				
Suture Bag	1		5	2
9099 Operation Tapes	2	4" x 21" (10cm x 55cm)		
9036 Mayo Stand Cover	1	23" x 54" (58cm x 137cm)		
Drape Sheet	1	45" x 60" (114cm x 152cm)		
9041 Extremity Cover	1	15" x 23" (38cm x 60cm)		
9053 Extremity Drape	1	90" x 118" (228cm x 300cm)		
9077 Back Table Cover	1	78" x 59" (200cm x 150cm)		

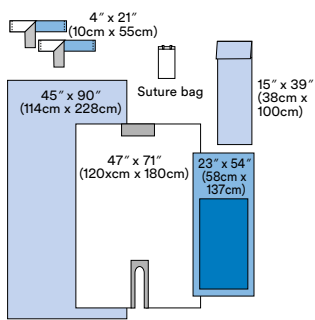

## 9021A Orthopaedic Set-Up Pack

Name	Quantity	Overall Size	Packs/Box	Boxes/Case
<b>9021A Orthopaedic Set-Up Pack</b>				
Suture Bag	1		15	2
9036 Mayo Stand Cover	1	23" x 54" (58cm x 137cm)		
9099 Operation Tape	2	4" x 21" (10cm x 55cm)		
9042 Extremity Cover	1	15" x 39" (38cm x 100cm)		
1019 Long U-drape	1	47" x 71" (120cm x 180cm)		
Back Table Cover	1	45" x 90" (114cm x 228cm)		



## 1014 Patient Isolation Drape

Overall Size	Drapes/Box	Boxes/Case
126" x 84" (320cm x 214cm)	5	4
<ul style="list-style-type: none"> <li>• Incise area: 19" x 10" (48cm x 25cm)</li> <li>• Adhesive strip along top</li> </ul>		
<b>1014NS</b> (non-sterile) <i>Custom Packs Only</i>	40 ea/cs	

### KEY

Absorbent Prevention Fabric	Standard Blue Fabric (fluid-repellent)	Clear plastic film	3M™ Ioban™ 2 Antimicrobial Incise Film	3M™ Steri-Drape™ 2 Incise Film	Adhesive area



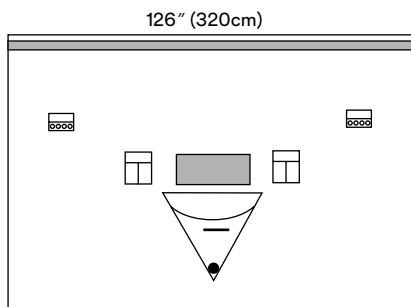

### 1017 Isolation Drape with Incise Film and Pouch

Overall Size	Drapes/Box	Boxes/Case
126" x 84" (320cm x 214cm)	5	4

- Incise area: 18" x 10" (48cm x 25cm)
- Fluid collection pouch with screen
- 1 – Exit port
- 2 – Instrument pouches
- 2 – Tube and cord organizers
- Adhesive strip along top

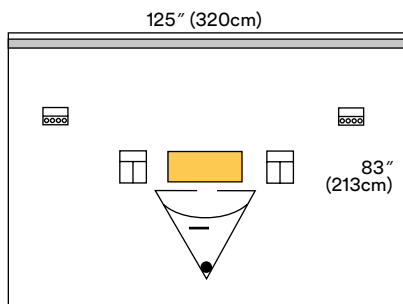

### 6617 Isolation Drape with loban™ 2 Incise Film and Pouch

Overall Size	Drapes/Box	Boxes/Case
125" x 83" (320cm x 213cm)	5	4

- loban 2 antimicrobial incise area: 19" x 9" (50cm x 24cm)
- Fluid collection pouch with screen
- 1 – Exit port
- 2 – Instrument pouches
- 2 – Tube and cord organizers
- Adhesive strip along top

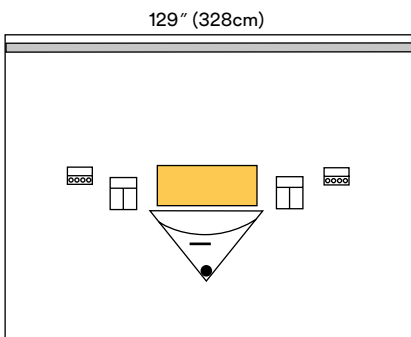

### 6619 Large Isolation Drape with loban 2 Incise Film and Pouch

Overall Size	Drapes/Box	Box/Case
129" x 100" (328cm x 254cm)	5	1

- loban 2 antimicrobial incise area: 27" x 12" (70cm x 32cm)
- Fluid collection pouch with screen
- 1 – Exit port
- 2 – Instrument pouches
- 2 – Tube and cord organizers

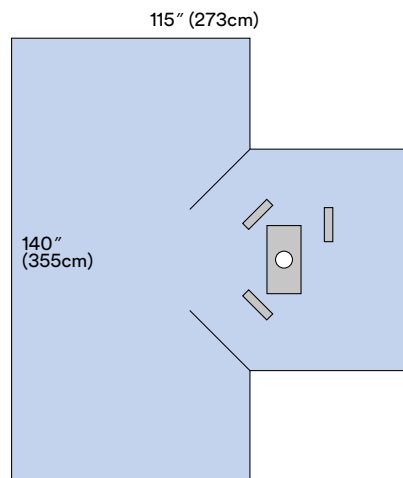

### 9052 Hand Drape

Overall Size	Drapes/Box	Boxes/Case
140" x 115" (355cm x 293cm)	9	2

- Elastic circle aperture: 1" (3cm)
- 3 – Tube and cord organizers

<b>9052NS</b> (non-sterile) <i>Custom Packs Only</i>	20 ea/cs
--	----------

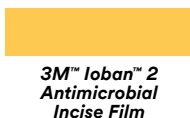

# 3M™ Steri-Drape™ ORTHOPAEDIC DRAPES

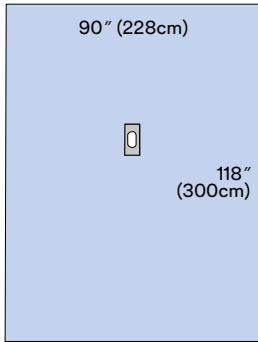

## 9053 Extremity Drape

Overall Size	Drapes/Box	Boxes/Case
90" x 118" (228cm x 300cm)	10	2
<ul style="list-style-type: none"> <li>Elastic aperture: 2" x 3" (6cm x 8cm)</li> </ul>		
<b>9053NS</b> (non-sterile) <i>Custom Packs Only</i>	18 ea/cs	

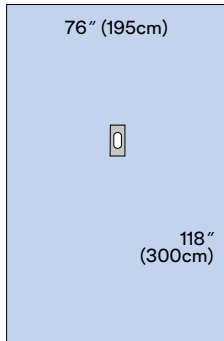

## 9054 Hand and Foot Drape

Overall Size	Drapes/Box	Boxes/Case
76" x 118" (195cm x 300cm)	15	2
<ul style="list-style-type: none"> <li>Elastic aperture: 1" (3cm)</li> </ul>		
<b>9054NS</b> (non-sterile) <i>Custom Packs Only</i>	30 ea/cs	

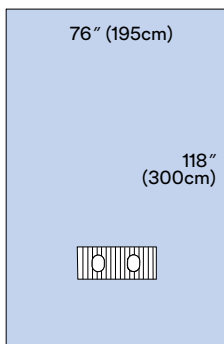

## 9056 Bilateral Foot Drape

Overall Size	Drapes/Box	Boxes/Case
76" x 118" (195cm x 300cm)	13	2
<ul style="list-style-type: none"> <li>Elastic apertures: 1.5" (4cm)</li> </ul>		
<b>9056NS</b> (non-sterile) <i>Custom Packs Only</i>	28 ea/cs	

### KEY

Absorbent  
Prevention Fabric

Standard Blue Fabric  
(fluid-repellent)

Clear plastic film

3M™ Ioban™ 2  
Antimicrobial  
Incise Film

3M™ Steri-Drape™ 2  
Incise Film

Adhesive area

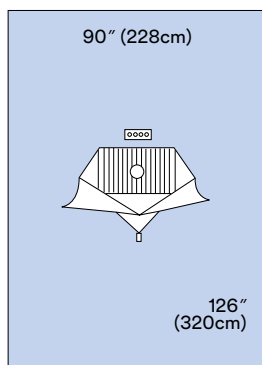

### 1094 Arthroscopy Sheet with Pouch

Overall Size	Drapes/Box	Boxes/Case
90" x 126" (228cm x 320cm)	20	1
<ul style="list-style-type: none"> <li>• Fluid collection pouch</li> <li>• 2 – Exit ports</li> <li>• Tube and cord organiser</li> </ul>		
<b>1094NS</b> (non-sterile) <i>Custom Packs Only</i>	30 ea/cs	

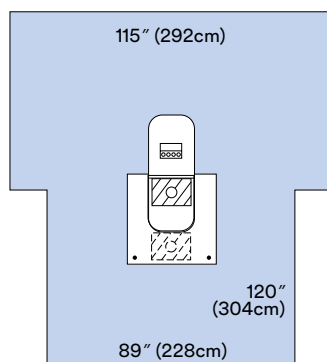

### 1194 Arthroscopy Sheet with Pouch

Overall Size	Drapes/Box	Boxes/Case
115" x 120" (292cm x 304cm)	5	1)
<ul style="list-style-type: none"> <li>• Fluid collection pouch</li> <li>• 2 – Exit ports</li> <li>• Tube and cord organiser</li> </ul>		
<b>1194NS</b> (non-sterile) <i>Custom Packs Only</i>	36 ea/cs	

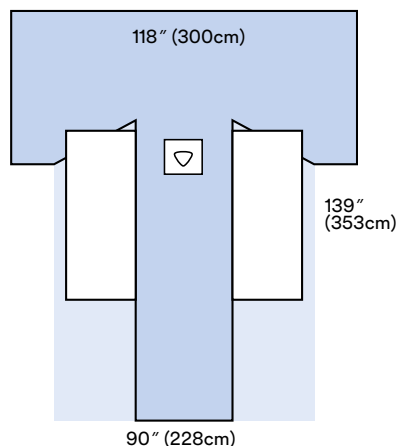

### 9055 Hip Drape with Pouches

Overall Size	Drapes/Box	Boxes/Case
118" x 139" (300cm x 353cm)	8	2
<ul style="list-style-type: none"> <li>• Adhesive strip on the inside of the drape</li> <li>• Large side pockets with flaps for fluid collection and control</li> </ul>		
<b>9055NS</b> (non-sterile) <i>Custom Packs Only</i>	15 ea/cs	

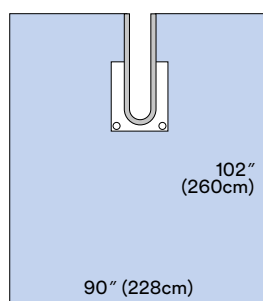

### 9196 Shoulder Split Sheet with Pouch

Overall Size	Drapes/Box	Boxes/Case
90" x 102" (228cm x 260cm)	10	2
<ul style="list-style-type: none"> <li>• Adhesive split: 6" x 37" (16cm x 95cm)</li> <li>• Fluid control pouch with 2 exit ports</li> </ul>		
<b>9196NS</b> (non-sterile) <i>Custom Packs Only</i>	25 ea/cs	



# 3M™ Steri-Drape™ ORTHOPAEDIC DRAPES

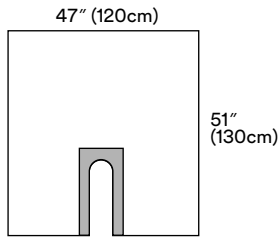

## 1015 U-drape

Overall Size	Drapes/Box	Boxes/Case
47" x 51" (120cm x 130cm)	10	4
<ul style="list-style-type: none"> <li>• Adhesive split: 7" x 18" (16.5cm x 46cm)</li> </ul>		
<b>1015NSD</b> (non-sterile)	100 ea/cs	
<b>1015NS</b> (non-sterile) <i>Custom Packs Only</i>	200 ea/cs	

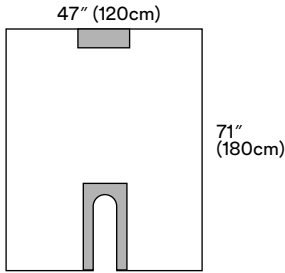

## 1019 Long U-drape

Overall Size	Drapes/Box	Boxes/Case
47" x 71" (120cm x 180cm)	10	4
<ul style="list-style-type: none"> <li>• Adhesive split: 7" x 18" (16.5cm x 46cm)</li> <li>• Adhesive patch</li> </ul>		
<b>1019NS</b> (non-sterile) <i>Custom Packs Only</i>	200 ea/cs	

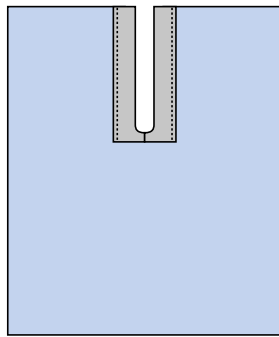

## Adhesive Split Sheets

	Overall Size	Split Size	Drapes/Box	Boxes/Case
<b>9043</b>	60" x 72" (152cm x 183cm)	2.5" x 25" (7x70cm)	30	2
<b>9044</b>	60" x 98" (152cm x 250cm)	2.5" x 25" (7x70cm)	25	2
<b>9045</b>	90" x 102" (228cm x 260cm)	8" x 39" (20cm x 100cm)	15	2
<b>9043NS</b> (non-sterile) <i>Custom Packs Only</i>			68 ea/cs	
<b>9044NS</b> (non-sterile) <i>Custom Packs Only</i>			58 ea/cs	
<b>9045NS</b> (non-sterile) <i>Custom Packs Only</i>			30 ea/cs	

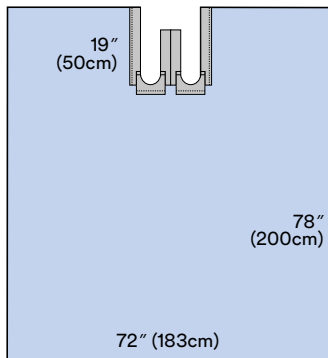

## 9046 Bilateral Adhesive Split Sheet

Overall Size	Drapes/Box	Boxes/Case
72" x 78" (183cm x 200cm)	15	2
<ul style="list-style-type: none"> <li>• Double adhesive split: 6" x 19" (15cm x 50cm)</li> </ul>		
<b>9046NS</b> (non-sterile) <i>Custom Packs Only</i>	30 ea/cs	

### KEY

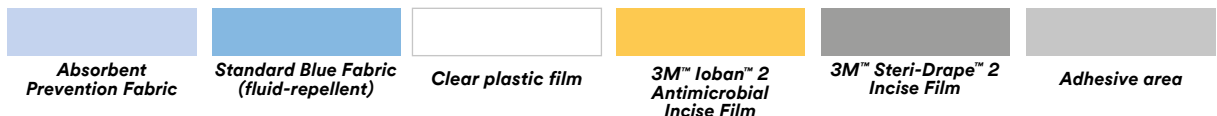



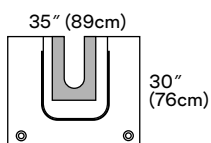

### 1067 U-pouch

Overall Size	Drapes/Box	Boxes/Case
35" x 30" (89cm x 76cm)	5	4
<ul style="list-style-type: none"> <li>• Adhesive split: 6" x 15" (16cm x 40cm)</li> <li>• Fluid collection pouch</li> <li>• 2 – Exit ports</li> </ul>		
<b>1067NS</b> (non-sterile) <i>Custom Packs Only</i>	50 ea/cs	

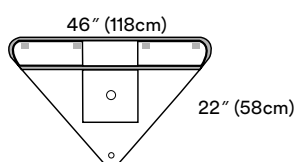

### 1007 Arthroscopy Fluid Collection Pouch

Overall Size	Drapes/Box	Boxes/Case
46" x 22" (118cm x 58cm)	10	4
<ul style="list-style-type: none"> <li>• Adhesive strip</li> <li>• 1 – Exit port</li> </ul>		

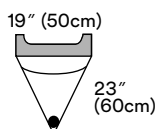

### 1016 Irrigation Pouch

Overall Size	Drapes/Box	Boxes/Case
19" x 23" (50cm x 60cm)	10	4
<ul style="list-style-type: none"> <li>• Adhesive strip</li> <li>• 1 – Exit port</li> <li>• Screen</li> </ul>		
<b>1016NS</b> (non-sterile) <i>Custom Packs Only</i>	200 ea/cs	

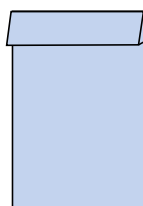

### Extremity Covers

	Overall Size	Drapes/Box	Boxes/Case
<b>9043</b>	15" x 23" (38cm x 60cm)	50	4
<b>9044</b>	15" x 39" (38cm x 100cm)	35	4
<b>9041NS</b> (non-sterile) <i>Custom Packs Only</i>		380 ea/cs	
<b>9042NS</b> (non-sterile) <i>Custom Packs Only</i>		250 ea/cs	



## CARDIOVASCULAR/CARDIAC CATHETERIZATION DRAPES

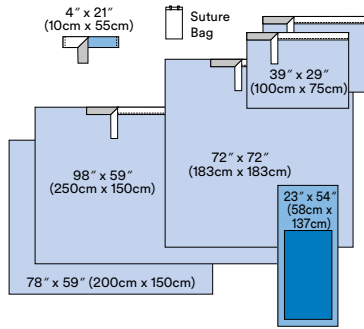

### 9000A Basic Surgical Pack

Name	Quantity	Overall Size	Packs/Box	Boxes/Case
<b>9000A Basic Surgical Pack</b>			7	2
Suture Bag	1			
9099 Operation Tape	1	4" x 21" (10cm x 55cm)		
9036 Mayo Stand Cover	1	23" x 54" (58cm x 137cm)		
9086 Adhesive Towel Drapes	2	39" x 30" (100cm x 76cm)		
9087 Adhesive Drape Sheet (M)	1	72" x 72" (183cm x 183cm)		
9088 Adhesive Drape Sheet (L)	1	98" x 59" (250cm x 150cm)		
9077 Back Table Cover	1	78" x 59" (200cm x 150cm)		

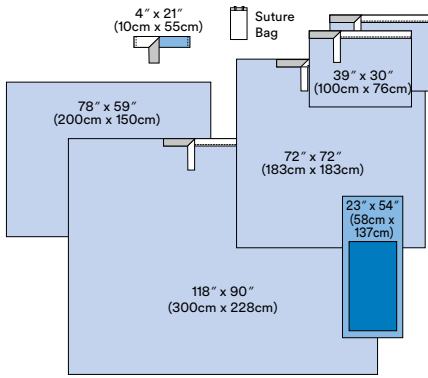

### 9000LA Basic Surgical Pack

Name	Quantity	Overall Size	Packs/Box	Boxes/Case
<b>9000LA Basic Surgical Pack</b>			5	2
Suture Bag	1			
9099 Operation Tape	1	4" x 21" (10cm x 55cm)		
9036 Mayo Stand Cover	1	23" x 54" (58cm x 137cm)		
9086 Adhesive Towel Drapes	2	39" x 30" (100cm x 76cm)		
9087 Adhesive Drape Sheet (M)	1	72" x 72" (183cm x 183cm)		
9090 Adhesive Drape Sheet (XL)	1	118" x 90" (300cm x 228cm)		
Back Table Cover	1	78" x 59" (200cm x 150cm)		

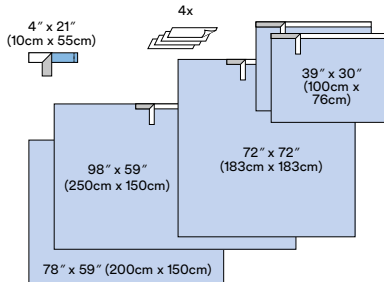

### 9010 Basic Surgical Pack without Mayo Stand Cover

Name	Quantity	Overall Size	Packs/Box	Boxes/Case
<b>9010 Basic Surgical Pack without Mayo Stand Cover</b>			7	2
9099 Operation Tape	1	4" x 21" (10cm x 55cm)		
Hand Towels	4	-		
9085 Adhesive Towel Drapes	2	39" x 33" (100cm x 85cm)		
9087 Adhesive Drape Sheet (M)	1	72" x 72" (183cm x 183cm)		
9088 Adhesive Drape Sheet (L)	1	98" x 59" (250cm x 150cm)		
9077 Back Table Cover	1	78" x 59" (200cm x 150cm)		

### KEY

Absorbent Prevention Fabric

Standard Blue Fabric (fluid-repellent)

Clear plastic film

3M™ Ioban™ 2 Antimicrobial Incise Film

3M™ Steri-Drape™ 2 Incise Film

Adhesive area

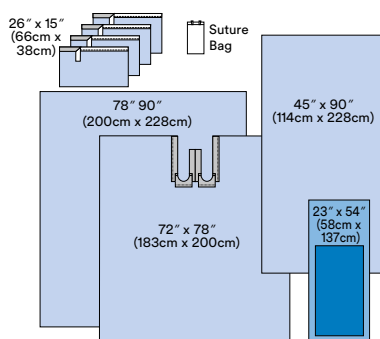

### 9022A Cardiovascular Set-Up Pack

Name	Quantity	Overall Size	Packs/Box	Boxes/Case
<b>9022A Cardiovascular Set-Up Pack</b>				
Suture Bag	1		7	2
9036 Mayo Stand Cover	1	23" x 54" (58cm x 137cm)		
9079 Back Table Cover	1	78" x 90" (200cm x 228cm)		
Utility Drapes	4	26" x 15" (66cm x 38cm)		
9046 Bilateral Split Sheet	1	72" x 78" (183cm x 200cm)		
Back Table Cover	1	45" x 90" (114cm x 228cm)		

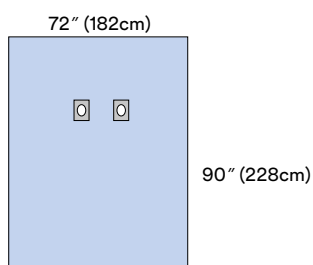

### 1090 Femoral Angiography Drape

Overall Size	Drapes/Box	Boxes/Case
72" x 90" (182cm x 228cm)	20	1
<ul style="list-style-type: none"> <li>• 2 – Adhesive patches: 4" x 6" (11.4cm x 14cm)</li> <li>• 2 – Oval apertures: 3" x 4" (6.4cm x 8.9cm)</li> </ul>		

<b>1090NS</b> (non-sterile) <i>Custom Packs Only</i>	50 ea/cs
--	----------

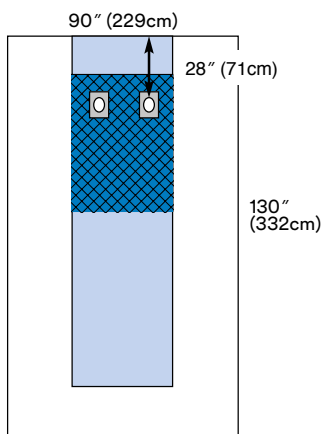

### 1191 Femoral Angiography Drape

Overall Size	Drapes/Box	Boxes/Case
90" x 130" (228cm x 330cm)	20	1
<ul style="list-style-type: none"> <li>• 2 – Adhesive patches: 4" x 6" (11.4cm x 14cm)</li> <li>• 2 – Oval apertures: 3" x 4" (7.6cm x 10.2cm)</li> <li>• Extra-absorbent critical zone</li> <li>• Transparent side and end panels</li> </ul>		

<b>• Absorbent Fabric</b>	20 ea/cs
---------------------------	----------

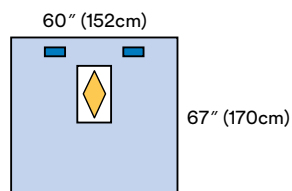

### 1192 Venous/Arterial Access Drape

Overall Size	Drapes/Box	Boxes/Case
60" x 67" (152cm x 170cm)	12	4
<ul style="list-style-type: none"> <li>• Designed for a variety of procedures, including: pacemaker insertion and repairs, brachial and radial artery access, radial artery harvesting, and central and PICC line insertions</li> <li>• Aperture: 152cm x 170cm (60" x 67")</li> </ul>		

<b>1192NS</b> (non-sterile) <i>Custom Packs Only</i>	68 ea/cs
--	----------

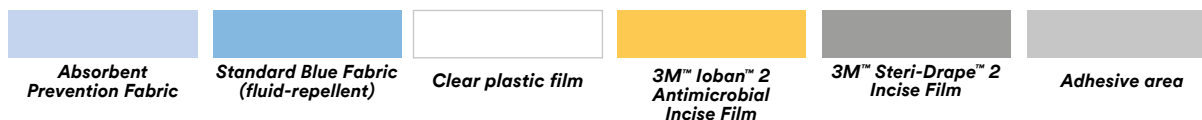

# CARDIOVASCULAR/CARDIAC CATHETERIZATION DRAPES

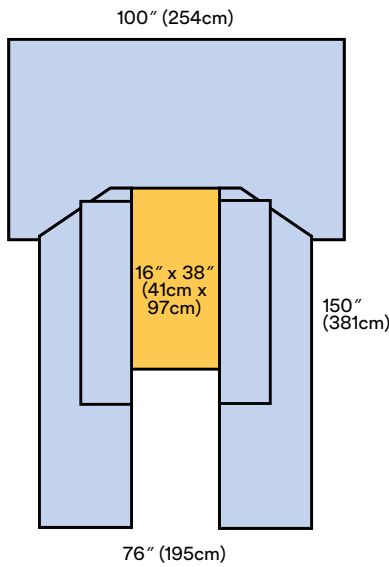

## 6677 Cardiovascular Sheet with loban 2 Incise Film

Overall Size	Drapes/Box	Boxes/Case
100" x 150" (254cm x 381cm)	6	1

- loban 2 antimicrobial incise area: 16" x 38" (41cm x 97cm)
- Dual side pockets
- Reinforced anesthesia screen

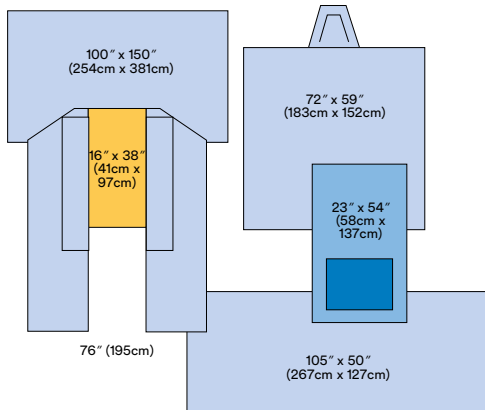

## 6678 Cardiovascular Pack

Name	Quantity	Overall Size	Packs/Box	Boxes/Case
<b>6678 Cardiovascular Pack</b>				
6677 Steri-Drape Cardiovascular Sheet with loban 2 Incise Film	1	100" x 150" (254cm x 381cm)	4	1
1083 Perineal/Leg Sheet	1	72" x 59" (183cm x 152cm)		
9036 Mayo Stand Cover	1	23" x 54" (58cm x 137cm)		
Back Table Cover	1	105" x 50" (267cm x 127cm)		

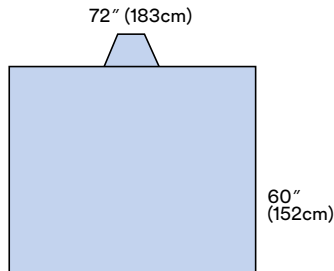

## 1083 Perineal/Leg Sheet

Overall Size	Drapes/Box	Boxes/Case
72" x 59" (183cm x 152cm)	50	2

**1083NS** (non-sterile) *Custom Packs Only*

90 ea/cs

### KEY

Absorbent Prevention Fabric	Standard Blue Fabric (fluid-repellent)	Clear plastic film	3M™ loban™ 2 Antimicrobial Incise Film	3M™ Steri-Drape™ 2 Incise Film	Adhesive area

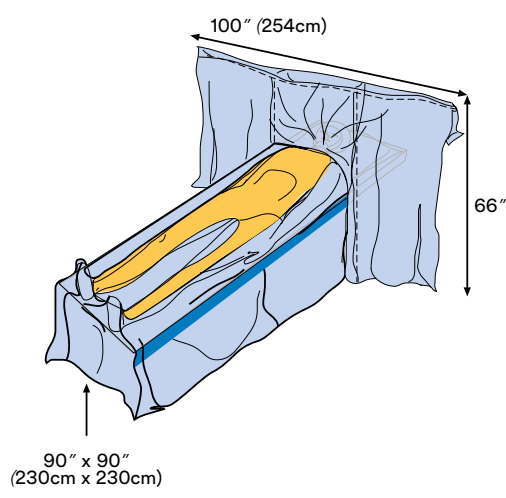

### 6681 Cardiovascular Drape with loban 2 Incise Film

Overall Size	Drapes/Box	Box/Case
100" x 151" (254cm x 384cm)	8	1

- loban 2 antimicrobial incise area: 16" x 61" (41cm x 154cm)
- One-piece design
- Expansion pleat between legs
- Blue anesthesia screen
- loban 2 antimicrobial incise film in both chest and leg areas

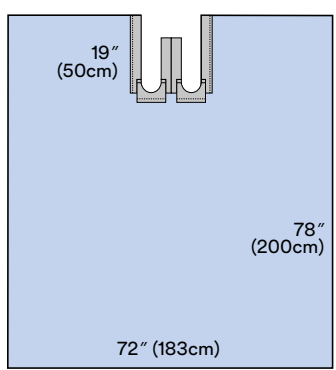

### 9046 Bilateral Adhesive Split Sheet

Overall Size	Drapes/Box	Boxes/Case
72" x 78" (183cm x 200cm)	15	2

- Double adhesive split: 5 7/8" x 19" (15cm x 50cm)

<b>9046NS</b> (non-sterile) <i>Custom Packs Only</i>	30 ea/cs	
--	----------	--

<b>Absorbent Prevention Fabric</b>	<b>Standard Blue Fabric (fluid-repellent)</b>	<b>Clear plastic film</b>	<b>3M™ loban™ 2 Antimicrobial Incise Film</b>	<b>3M™ Steri-Drape™ 2 Incise Film</b>	<b>Adhesive area</b>



## OBSTETRICS AND GYNAECOLOGY DRAPES

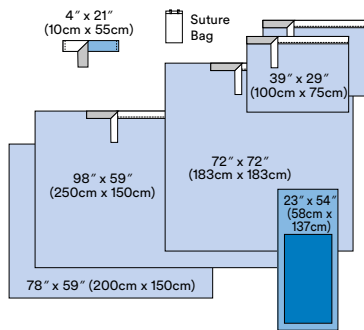

### 9000A Basic Surgical Pack

Name	Quantity	Overall Size	Packs/Box	Boxes/Case
<b>9000A Basic Surgical Pack</b>				
Suture Bag	1		7	2
9099 Operation Tape	1	4" x 21" (10cm x 55cm)		
9036 Mayo Stand Cover	1	23" x 54" (58cm x 137cm)		
9086 Adhesive Towel Drapes	2	39" x 30" (100cm x 76cm)		
9087 Adhesive Drape Sheet (M)	1	72" x 72" (183cm x 183cm)		
9088 Adhesive Drape Sheet (L)	1	98" x 59" (250cm x 150cm)		
9077 Back Table Cover	1	78" x 59" (200cm x 150cm)		

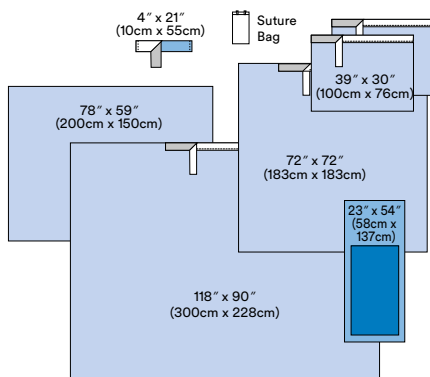

### 9000LA Basic Surgical Pack

Name	Quantity	Overall Size	Packs/Box	Boxes/Case
<b>9000LA Basic Surgical Pack</b>				
Suture Bag	1		5	2
9099 Operation Tape	1	4" x 21" (10cm x 55cm)		
9036 Mayo Stand Cover	1	23" x 54" (58cm x 137cm)		
9086 Adhesive Towel Drapes	2	39" x 30" (100cm x 76cm)		
9087 Adhesive Drape Sheet (M)	1	72" x 72" (183cm x 183cm)		
9090 Adhesive Drape Sheet (XL)	1	118" x 90" (300cm x 228cm)		
9077 Back Table Cover	1	78" x 59" (200cm x 150cm)		

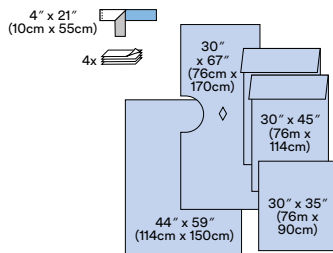

### 9003 Cystoscopy Pack

Name	Quantity	Overall Size	Packs/Box	Boxes/Case
<b>9003 Cystoscopy Pack</b>				
9099 Operation Tape	1	4" x 21" (10cm x 55cm)	10	2
Hand Towels	4	-		
9040 Leggings (pair)	1	30" x 45" (76cm x 114cm)		
9069 Drape Sheet	1	30" x 35" (76cm x 90cm)		
9023 Perineal Aperture Drape	1	30" x 67" (76cm x 170cm)		
9072 Back Table Cover	1	44" x 59" (114cm x 150cm)		

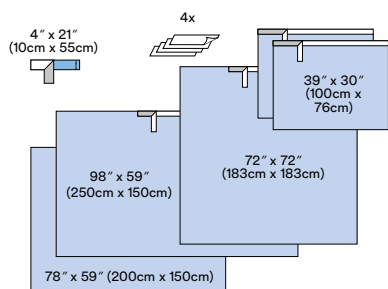

### 9010 Basic Surgical Pack without Mayo Stand Cover

Name	Quantity	Overall Size	Packs/Box	Boxes/Case
<b>9010 Basic Surgical Pack without Mayo Stand Cover</b>				
9099 Operation Tape	1	4" x 21" (10cm x 55cm)	7	2
Hand Towels	4	-		
9085 Adhesive Towel Drapes	2	39" x 33" (100cm x 85cm)		
9087 Adhesive Drape Sheet (M)	1	72" x 72" (183cm x 183cm)		
9088 Adhesive Drape Sheet (L)	1	98" x 59" (250cm x 150cm)		
9077 Back Table Cover	1	78" x 59" (200cm x 150cm)		

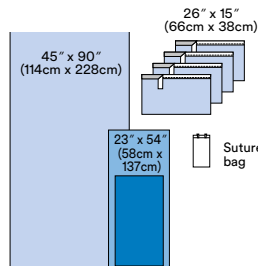

### 9020A Basic Set-Up Pack

Name	Quantity	Overall Size	Packs/Box	Boxes/Case
<b>9020A Basic Set-Up Pack</b>				
Suture Bag	1		20	2
9036 Mayo Stand Cover	1	23" x 54" (58cm x 137cm)		
Utility Drapes	4	26" x 15" (66cm x 38cm)		
Back Table Cover	1	45" x 90" (114cm x 228cm)		



**Absorbent Prevention Fabric**

**Standard Blue Fabric (fluid-repellent)**

**Clear plastic film**

**3M™ Ioban™ 2 Antimicrobial Incise Film**

**3M™ Steri-Drape™ 2 Incise Film**

**Adhesive area**



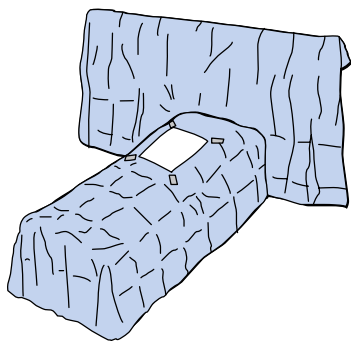

### 1031 Laparoscopic Drape/Supine Position

Overall Size	Drapes/Box	Boxes/Case
112" x 90" (285cm x 228cm)	10	2
<ul style="list-style-type: none"> <li>• Adhesive aperture: 10" x 11" (27cm x 30cm)</li> <li>• 4 – Tube organizers (ref.1115)</li> </ul>		
<b>1031NS</b> (non-sterile) <i>Custom Packs Only</i>	30 ea/cs	

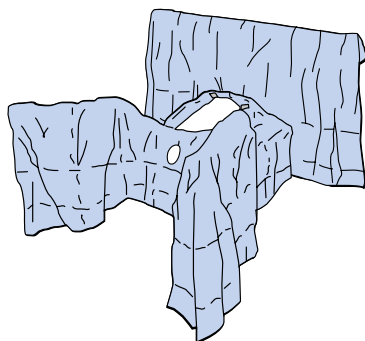

### 1032 Laparoscopic Drape/Lithotomy Position

Overall Size	Drapes/Box	Boxes/Case
95" x 90" (241cm x 228cm)	8	2
<ul style="list-style-type: none"> <li>• Adhesive aperture: 11" x 12" (27cm x 30cm)</li> <li>• Peri/vag. aperture: 5" x 6" (12cm x 15.5cm)</li> <li>• Leggings: 46" (117cm)</li> <li>• 4 – Tube organizers (ref.1115)</li> </ul>		
<b>1032NS</b> (non-sterile) <i>Custom Packs Only</i>	20 ea/cs	

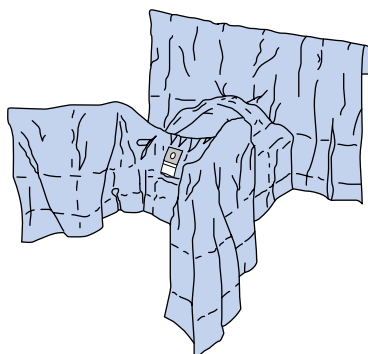

### 1080 Gynaecology Drape

Overall Size	Drapes/Box	Boxes/Case
77" x 70" (195cm x 179cm)	14	2
<ul style="list-style-type: none"> <li>• Peri/vag. aperture: 4" x 5" (9cm x 12cm)</li> <li>• Tube and cord organizers (ref.1115)</li> <li>• Fluid collection pouch (ref.)</li> </ul>		
<b>1080NS</b> (non-sterile) <i>Custom Packs Only</i>	30 ea/cs	
Leggings 46" (117cm)		



### 2065 Abdominoperineal Incise Drape

Overall Size	Drapes/Box	Boxes/Case
77" x 160" (195cm x 271cm)	8	2
<ul style="list-style-type: none"> <li>• Steri-Drape 2 incise area: 16" x 17.5" (41cm x 45cm)</li> <li>• Peri/vag. aperture: 5" x 6" (12cm x 15.5cm)</li> <li>• Tube and cord organizers (ref.1115)</li> </ul>		
<b>2065NS</b> (non-sterile) <i>Custom Packs Only</i>	20 ea/cs	



# OBSTETRICS AND GYNAECOLOGY DRAPES

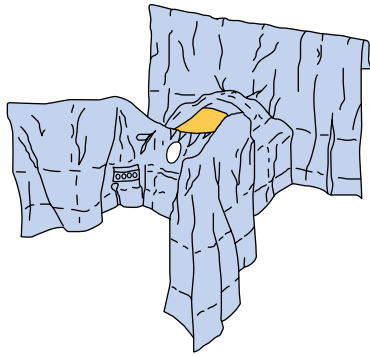

## 6665 Abdominal-Perineal Drape with loban 2 Incise Film – Lithotomy Position

Overall Size	Drapes/Box	Boxes/Case
78" x 107" (200cm x 274cm)	5	1

- loban 2 antimicrobial incise area: 13" x 17" (33cm x 45cm)
- Peri/vag. aperture: 4<sup>5</sup>/<sub>8</sub>" x 6" (12cm x 15.5cm)
- Tube and cord organizers (ref.1115)

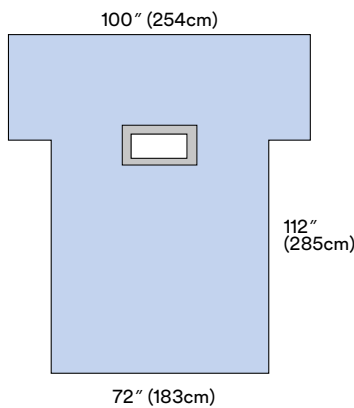

## 9062 Laparotomy Drape (Transverse)

Overall Size	Drapes/Box	Boxes/Case
72" x 112" (183cm x 285cm)	12	2

- Aperture: 12" x 4" (30cm x 10cm)

<b>9062NS</b> (non-sterile) <i>Custom Packs Only</i>	30 ea/cs	
--	----------	--

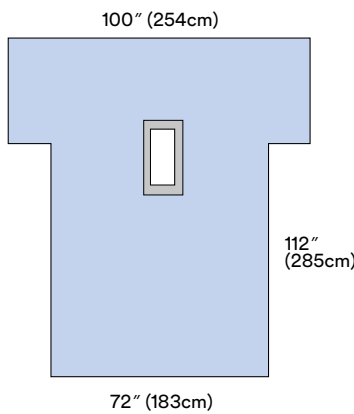

## 9063 Laparotomy Drape

Overall Size	Drapes/Box	Boxes/Case
100" x 112" (254cm x 285cm)	10	2

- Aperture: 4" x 12" (10cm x 30cm)

<b>9063NS</b> (non-sterile) <i>Custom Packs Only</i>	30 ea/cs	
--	----------	--

### KEY

 Absorbent Prevention Fabric

 Standard Blue Fabric (fluid-repellent)

 Clear plastic film

 3M™ loban™ 2 Antimicrobial Incise Film

 3M™ Steri-Drape™ 2 Incise Film

 Adhesive area

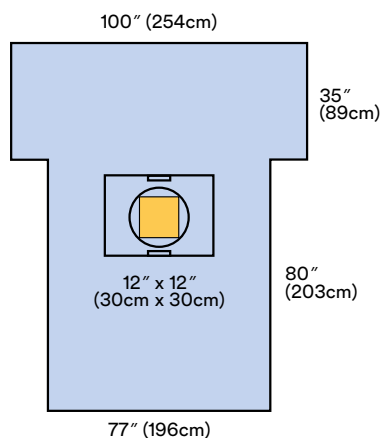

### 6697 Cesarean Section Sheet with loban 2 Incise Pouch

Overall Size	Drapes/Box	Box/Case
100" x 115" (254cm x 292cm)	5	1

- loban 2 antimicrobial incise area: 12" x 12" (30cm x 30cm)
- 360-degree fluid collection pouch
- Tube and cord organizers

### 6697CA Cesarean-Section Drape with loban 2 Incise Pouch and Clear Anesthesia Screen

Overall Size	Drapes/Box	Box/Case
100" x 115" (254cm x 292cm)	5	1

- loban 2 antimicrobial incise area: 12" x 12" (30cm x 30cm)
- Clear anesthesia screen allows mother to see the birth
- 360-degree fluid collection pouch
- Tube and cord organizers

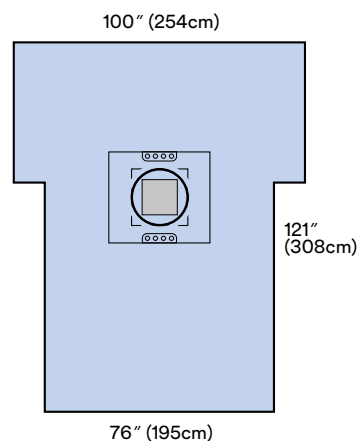

### 7965 Cesarean Section Drape with Incise Sheet with Pouch

Overall Size	Drapes/Box	Boxes/Case
100" x 121" (254cm x 308cm)	5	1

- Incise area: 12" x 12" (30cm x 30cm)
- 360-degree fluid collection pouch
- Tube and cord organizers

<b>7965NS</b> (non-sterile) <i>Custom Packs Only</i>	18 ea/cs
--	----------

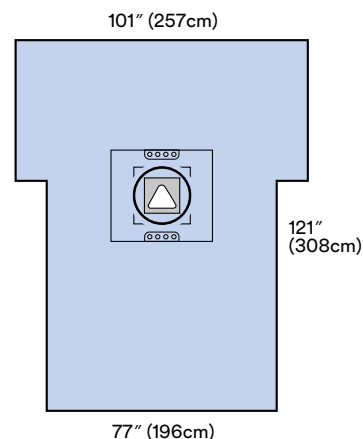

### 7966 Cesarean Section Sheet with Aperture Pouch

Overall Size	Drapes/Box	Boxes/Case
60" x 121" (254cm x 308cm)	5	1

- Aperture incise area: 12" x 12" (30cm x 30cm)
- 360-degree fluid collection pouch
- Tube and cord organizers

<b>7966NS</b> (non-sterile) <i>Custom Packs Only</i>	18 ea/cs
--	----------

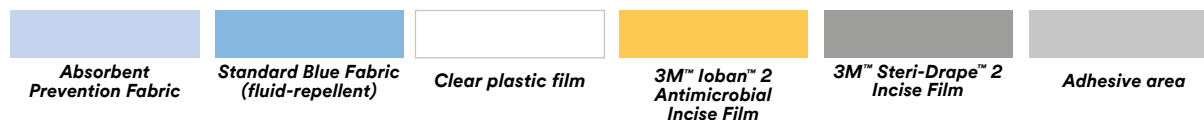

# OBSTETRICS AND GYNAECOLOGY DRAPES

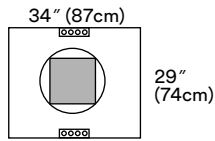

## 2057 Incise Pouch

Overall Size	Drapes/Box	Boxes/Case
34" x 29" (87cm x 74cm)	10	4

- Incise area: 12" x 12" (30cm x 30cm)
- 360-degree fluid collection pouch
- Tube and cord organizers

<b>2057NS</b> (non-sterile) <i>Custom Packs Only</i>	100 ea/cs
--	-----------

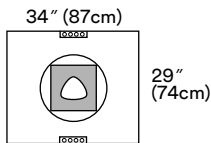

## 2058 Aperture Pouch Drape

Overall Size	Drapes/Box	Boxes/Case
34" x 29" (87cm x 74cm)	10	4

- Aperture incise area: 12" x 12" (30cm x 30cm)
- 360-degree fluid collection pouch
- Tube and cord organizers

<b>2058NS</b> (non-sterile) <i>Custom Packs Only</i>	100 ea/cs
--	-----------

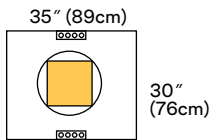

## 6657 Pouch with Ioban 2 Incise Film

Overall Size	Drapes/Box	Boxes/Case
34" x 29" (87cm x 74cm)	10	4

- Ioban 2 antimicrobial incise area: 11" x 11" (30cm x 30cm)
- 360-degree fluid collection pouch
- Tube and cord organizers

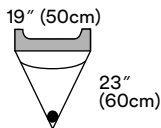

## 1016 Irrigation Pouch

Overall Size	Drapes/Box	Boxes/Case
Size: 19" x 23" (50cm x 60cm)	10	4

- Adhesive strip
- 1 – Exit port
- Screen

<b>1016NS</b> (non-sterile) <i>Custom Packs Only</i>	200 ea/cs
--	-----------

### KEY

Absorbent Prevention Fabric

Standard Blue Fabric (fluid-repellent)

Clear plastic film

3M™ Ioban™ 2 Antimicrobial Incise Film

3M™ Steri-Drape™ 2 Incise Film

Adhesive area

9" (23cm)

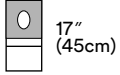

### 1072 Aperture Pouch Drape

Overall Size	Packs/Box	Boxes/Case
9" x 17" (23cm x 45cm)	10	4
<ul style="list-style-type: none"> <li>• Adhesive area: 9" x 10" (23cm x 25cm)</li> <li>• Oval aperture: 3.5" x 4.25" (9cm x 11cm)</li> <li>• Fluid collection pouch</li> </ul>		
<b>1072NS</b> (non-sterile) <i>Custom Packs Only</i>	200 ea/cs	

34" (86cm)

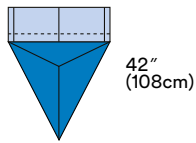

### 1084 Under Buttocks Drape with Pouch

Overall Size	Drapes/Box	Boxes/Case
34" x 42" (86cm x 108cm)	30	4
<ul style="list-style-type: none"> <li>• Cuff size: 10" (25.4cm)</li> <li>• Fluid collection pouch</li> </ul>		
<b>1084NS</b> (non-sterile) <i>Custom Packs Only</i>	140 ea/cs	

29" (75cm)

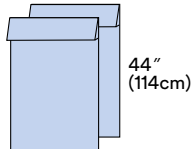

### 9040 Leggings (2)

Overall Size	Drapes/Box	Boxes/Case
29" x 44" (75cm x 114cm)	10	4
<b>9040NS</b> (non-sterile) <i>Custom Packs Only</i>	116 ea/cs	

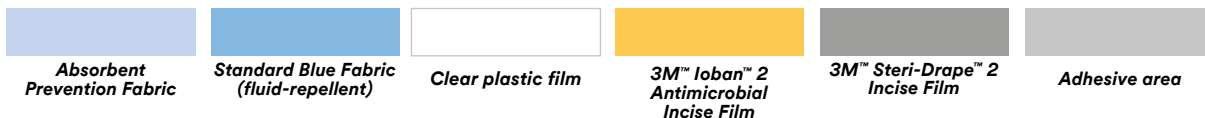

# 3M™ Steri-Drape™ EENT DRAPES

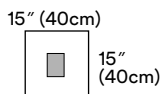
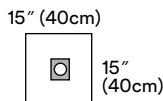
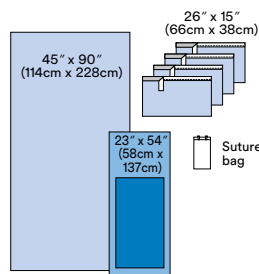
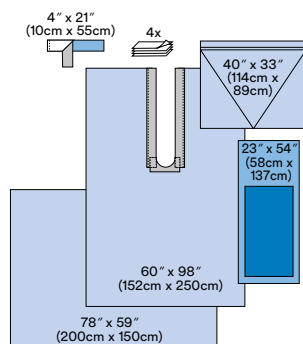
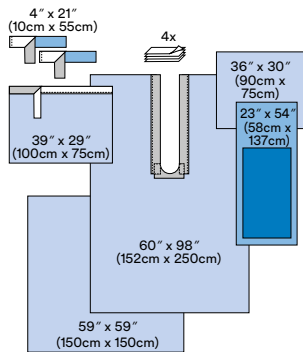

## 9007A ENT Pack

Name	Quantity	Overall Size	Packs/Box	Boxes/Case
<b>9007A ENT Pack</b>				
9099 Operation Tape	2	4" x 21" (10cm x 55cm)	8	2
9036 Mayo Stand Cover	1	23" x 54" (58cm x 137cm)		
9069 Drape Sheet	1	35" x 30" (90cm x 76cm)		
9044 Adhesive Split Sheet	1	60" x 98" (152cm x 250cm)		
9086 Adhesive Towel Drape	1	39" x 30" (100cm x 76cm)		
9074 Back Table Cover	1	59" x 59" (150cm x 150cm)		

## 9008A Head and Neck Pack

Name	Quantity	Overall Size	Packs/Box	Boxes/Case
<b>9008A Head and Neck Pack</b>				
9099 Operation Tape	1	4" x 21" (10cm x 55cm)	8	2
9036 Mayo Stand Cover	1	23" x 54" (58cm x 137cm)		
9070 Turban Drape Sheet	1	40" x 33" (114cm x 89cm)		
9044 Adhesive Split Sheet	1	60" x 98" (152cm x 250cm)		
9077 Back Table Cover	1	78" x 59" (200cm x 150cm)		

## 9020A Basic Set-Up Pack

Name	Quantity	Overall Size	Packs/Box	Boxes/Case
<b>9020A Basic Set-Up Pack</b>				
Suture Bag	1		20	2
9036 Mayo Stand Cover	1	23" x 54" (58cm x 137cm)		
Utility Drapes	4	26" x 15" (66cm x 38cm)		
Back Table Cover	1	45" x 90" (114cm x 228cm)		

## 1020 Small Drape with Adhesive Aperture

Overall Size	Drapes/Box	Boxes/Case
15" x 15" (40cm x 40cm)	10	4
<ul style="list-style-type: none"> <li>Adhesive area: 3<sup>7</sup>/<sub>8</sub>" x 4<sup>7</sup>/<sub>8</sub>" (10cm x 12.5cm)</li> <li>Circle aperture: 2<sup>3</sup>/<sub>8</sub>" (6.3cm)</li> </ul>		
<b>1020NS</b> (non-sterile) <i>Custom Packs Only</i>	200 ea/cs	

## 1021 Small Drape with Incise Film

Overall Size	Drapes/Box	Boxes/Case
15" x 15" (40cm x 40cm)	10	4
<ul style="list-style-type: none"> <li>Incise area: 3<sup>7</sup>/<sub>8</sub>" x 4<sup>7</sup>/<sub>8</sub>" (10cm x 12.5cm)</li> </ul>		
<b>1021NS</b> (non-sterile) <i>Custom Packs Only</i>	200 ea/cs	

**KEY**

 Absorbent Prevention Fabric

 Standard Blue Fabric (fluid-repellent)

 Clear plastic film

 3M™ Ioban™ 2 Antimicrobial Incise Film

 3M™ Steri-Drape™ 2 Incise Film

 Adhesive area



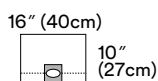

### 1022 Refractive Drape

Overall Size	Drapes/Box	Boxes/Case
16" x 11" (40cm x 27.5cm)	20	4
<ul style="list-style-type: none"> <li>• Adhesive area: 3" x 3" (7.2cm x 7.2cm)</li> <li>• Oval aperture: 2" x 2" (4.4cm x 3.8cm)</li> <li>• Perforated</li> </ul>		
<b>1022NS</b> (non-sterile) <i>Custom Packs Only</i>	200 ea/cs	

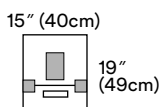

### 1023 Small Drape with Incise Film and Pouch

Overall Size	Drapes/Box	Boxes/Case
15" x 19" (40cm x 49cm)	10	4
<ul style="list-style-type: none"> <li>• Incise area: 4" x 5" (10cm x 12.5cm)</li> <li>• 2 – Adhesive patches</li> <li>• Fluid collection pouch</li> </ul>		
<b>1023NS</b> (non-sterile) <i>Custom Packs Only</i>	200 ea/cs	

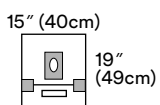

### 1024 Small Drape with Adhesive Aperture and Pouch

Overall Size	Drapes/Box	Boxes/Case
15" x 19" (40cm x 49cm)	10	4
<ul style="list-style-type: none"> <li>• Adhesive area: 4" x 5" (10cm x 12.5cm)</li> <li>• Oval aperture: 1" x 2" (3.5cm x 6.3cm)</li> <li>• 2 – Adhesive patches</li> <li>• Fluid collection pouch</li> </ul>		
<b>1024NS</b> (non-sterile) <i>Custom Packs Only</i>	200 ea/cs	

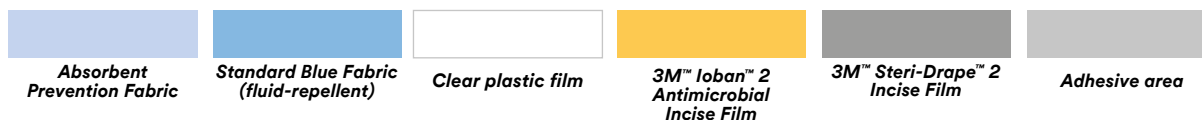

# 3M™ Steri-Drape™ EENT DRAPES

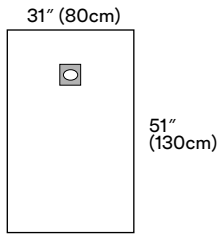

## 1030 Medium Drape with Adhesive Aperture

Overall Size	Drapes/Box	Boxes/Case
31" x 51" (80cm x 130cm)	10	4
<ul style="list-style-type: none"> <li>• Adhesive area: 3<sup>7</sup>/<sub>8</sub>" x 4<sup>7</sup>/<sub>8</sub>" (10cm x 12.5cm)</li> <li>• Oval aperture: 2" x 2<sup>7</sup>/<sub>8</sub>" (5.2cm x 7.6cm)</li> </ul>		
<b>1030NS</b> (non-sterile) <i>Custom Packs Only</i>	200 ea/cs	

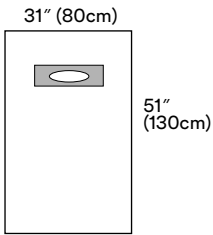

## 1033 Medium Drape with Wide Adhesive Aperture

Overall Size	Drapes/Box	Boxes/Case
31" x 51" (80cm x 130cm)	10	4
<ul style="list-style-type: none"> <li>• Adhesive area: 9" x 4" (22.9cm x 11.4cm)</li> <li>• Oval aperture: 7" x 3" (17.1cm x 6.7cm)</li> </ul>		
<b>1033NS</b> (non-sterile) <i>Custom Packs Only</i>	200 ea/cs	

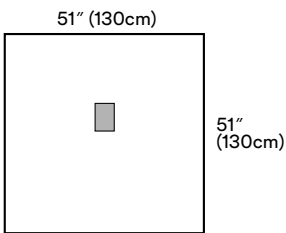

## 1060 Medium Drape with Incise Film

Overall Size	Drapes/Box	Boxes/Case
51" x 51" (130cm x 130cm)	10	4
<ul style="list-style-type: none"> <li>• Incise area: 4" x 5" (10cm x 12.5cm)</li> </ul>		
<b>1060NS</b> (non-sterile) <i>Custom Packs Only</i>	200 ea/cs	

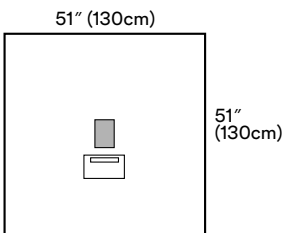

## 1061 Medium Drape with Incise Film and Pouch

Overall Size	Drapes/Box	Boxes/Case
51" x 51" (130cm x 130cm)	10	4
<ul style="list-style-type: none"> <li>• Incise area: 4" x 5" (10cm x 12.5cm)</li> <li>• Fluid collection pouch</li> </ul>		
<b>1061NS</b> (non-sterile) <i>Custom Packs Only</i>	200 ea/cs	

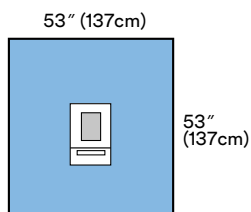

### 1062 Ophthalmic Incise Drape with Pouch

Overall Size	Drapes/Box	Boxes/Case
53" x 53" (137cm x 137cm)	30	2
<ul style="list-style-type: none"> <li>• Incise area: 3" x 4" (8cm x 10cm)</li> <li>• Fluid collection pouch</li> </ul>		
<b>1062NS</b> (non-sterile) <i>Custom Packs Only</i>	100 ea/cs	

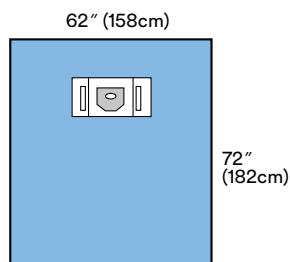

### 1064 Ophthalmic Sheet with Aperture and Pouches

Overall Size	Drapes/Box	Boxes/Case
62" x 72" (158cm x 182cm)	20	2
<ul style="list-style-type: none"> <li>• Adhesive area: 2" x 1" (6cm x 3cm)</li> <li>• Oval aperture: 2" x 1" (6cm x 3cm)</li> <li>• 2 – Fluid collection pouches</li> </ul>		
<b>1064NS</b> (non-sterile) <i>Custom Packs Only</i>	54 ea/cs	

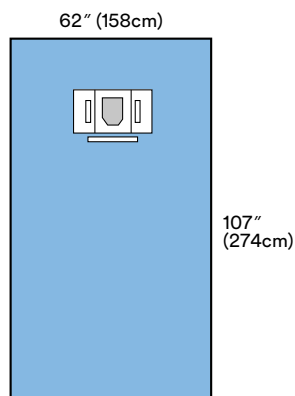

### 1055B Large Ophthalmic Sheet with Incise Film and Pouches

Overall Size	Drapes/Box	Boxes/Case
62" x 108" (158cm x 274cm)	14	2
<ul style="list-style-type: none"> <li>• Incise area: 4" x 5" (9cm x 12cm)</li> <li>• 2 – Fluid collection pouches</li> <li>• Face arch</li> </ul>		
<b>1055NS</b> (non-sterile) <i>Custom Packs Only</i>	35 ea/cs	

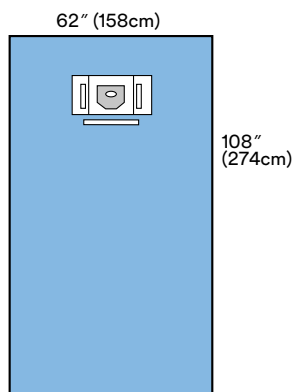

### 1065B Large Ophthalmic Sheet with Aperture and Pouches

Overall Size	Drapes/Box	Boxes/Case
62" x 108" (158cm x 274cm)	14	2
<ul style="list-style-type: none"> <li>• Adhesive area: 4" x 5" (9cm x 11.7cm)</li> <li>• Oval aperture: 2" x 1" (6cm x 3cm)</li> <li>• 2 – Fluid collection pouches</li> <li>• Face arch</li> </ul>		
<b>1065NS</b> (non-sterile) <i>Custom Packs Only</i>	35 ea/cs	



# 3M™ Steri-Drape™ GENERAL SURGERY DRAPES

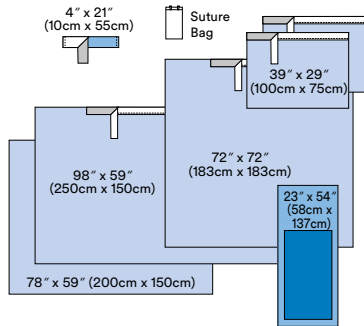

## 9000A Basic Surgical Pack

Name	Quantity	Overall Size	Packs/Box	Boxes/Case
<b>9000A Basic Surgical Pack</b>			7	2
Suture Bag	1			
9099 Operation Tape	1	4" x 21" (10cm x 55cm)		
9036 Mayo Stand Cover	1	23" x 54" (58cm x 137cm)		
9086 Adhesive Towel Drapes	2	39" x 30" (100cm x 76cm)		
9087 Adhesive Drape Sheet (M)	1	72" x 72" (183cm x 183cm)		
9088 Adhesive Drape Sheet (L)	1	98" x 59" (250cm x 150cm)		
9077 Back Table Cover	1	78" x 59" (200cm x 150cm)		

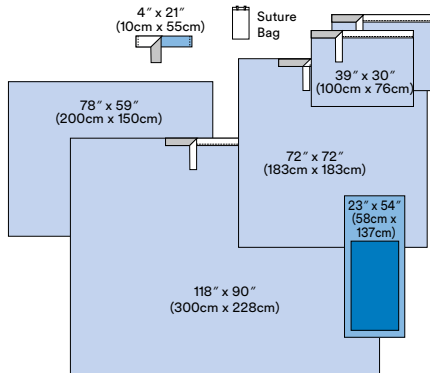

## 9000LA Basic Surgical Pack

Name	Quantity	Overall Size	Packs/Box	Boxes/Case
<b>9000LA Basic Surgical Pack</b>			5	2
Suture Bag	1			
9099 Operation Tape	1	4" x 21" (10cm x 55cm)		
9036 Mayo Stand Cover	1	23" x 54" (58cm x 137cm)		
9086 Adhesive Towel Drapes	2	39" x 30" (100cm x 76cm)		
9087 Adhesive Drape Sheet (M)	1	72" x 72" (183cm x 183cm)		
9090 Adhesive Drape Sheet (XL)	1	118" x 90" (300cm x 228cm)		
9077 Back Table Cover	1	78" x 59" (200cm x 150cm)		

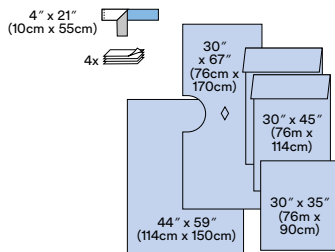

## 9003 Cystoscopy Pack

Name	Quantity	Overall Size	Packs/Box	Boxes/Case
<b>9003 Cystoscopy Pack</b>			10	2
9099 Operation Tape	1	4" x 21" (10cm x 55cm)		
Hand Towels	4	-		
9040 Leggings (pair)	1	30" x 45" (76cm x 114cm)		
9069 Drape Sheet	1	30" x 35" (76cm x 90cm)		
9023 Perineal Aperture Drape	1	30" x 67" (76cm x 170cm)		
9072 Back Table Cover	1	44" x 59" (114cm x 150cm)		

**KEY**

  
Absorbent  
Prevention Fabric

  
Standard Blue Fabric  
(fluid-repellent)

  
Clear plastic film

  
3M™ Ioban™ 2  
Antimicrobial  
Incise Film

  
3M™ Steri-Drape™ 2  
Incise Film

  
Adhesive area

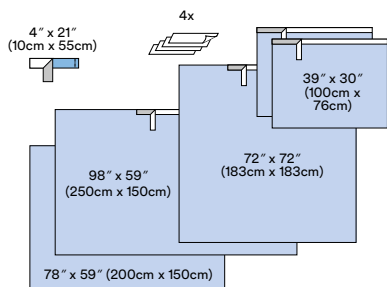

### 9010 Basic Surgical Pack without Mayo Stand Cover

Name	Quantity	Overall Size	Packs/Box	Boxes/Case
<b>9010 Basic Surgical Pack without Mayo Stand Cover</b>				
9099 Operation Tape	1	4" x 21" (10cm x 55cm)	7	2
Hand Towels	4	-		
9085 Adhesive Towel Drapes	2	39" x 33" (100cm x 85cm)		
9087 Adhesive Drape Sheet (M)	1	72" x 72" (183cm x 183cm)		
9088 Adhesive Drape Sheet (L)	1	98" x 59" (250cm x 150cm)		
9077 Back Table Cover	1	78" x 59" (200cm x 150cm)		

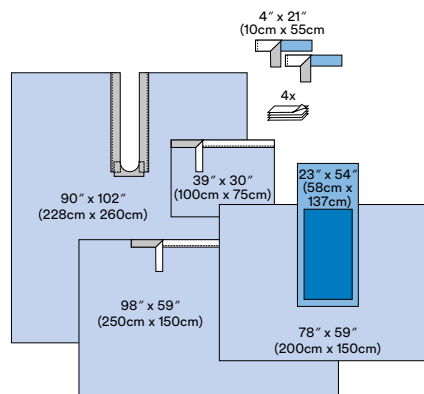

### 9018A Surgical Split Sheet Pack

Name	Quantity	Overall Size	Packs/Box	Boxes/Case
<b>9018A Surgical Split Sheet Pack</b>				
9099 Operation Tape	2	4" x 21" (10cm x 55cm)	6	2
9036 Mayo Stand Cover	1	23" x 54" (58cm x 137cm)		
9086 Adhesive Towel Drape	1	39" x 30" (100cm x 76cm)		
9045 Adhesive Split Sheet	1	90" x 102" (228cm x 260cm)		
9088 Adhesive Drape Sheet (L)	1	98" x 59" (250cm x 150cm)		
9077 Back Table Cover	1	78" x 59" (200cm x 150cm)		

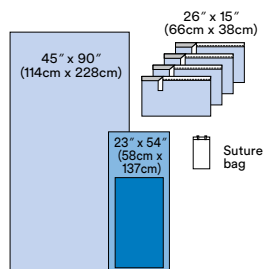

### 9020A Basic Set-Up Pack

Name	Quantity	Overall Size	Packs/Box	Boxes/Case
<b>9020A Basic Set-Up Pack</b>				
Suture Bag	1		20	2
9036 Mayo Stand Cover	1	23" x 54" (58cm x 137cm)		
Utility Drapes	4	26" x 15" (66cm x 38cm)		
Back Table Cover	1	45" x 90" (114cm x 228cm)		

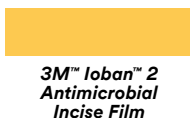

# 3M™ Steri-Drape™

## GENERAL SURGERY DRAPES

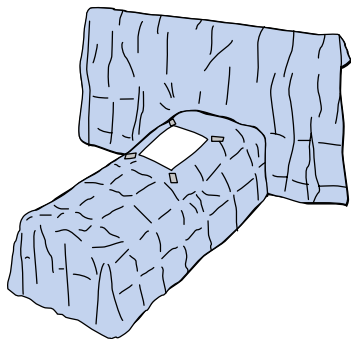

### 1031 Laparoscopic Drape/Supine Position

Overall Size	Drapes/Box	Boxes/Case
112" x 90" (285cm x 228cm)	10	2

- Adhesive aperture: 10" x 11" (27cm x 30cm)
- 4 – Tube organizers (ref.1115)

**1031NS** (non-sterile) *Custom Packs Only* 30 ea/cs

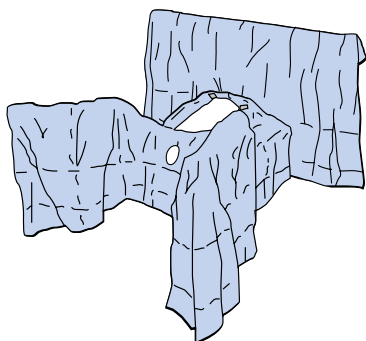

### 1032 Laparoscopic Drape/Lithotomy Position

Overall Size	Drapes/Box	Boxes/Case
95" x 90" (241cm x 228cm)	8	2

- Adhesive aperture: 11" x 12" (27cm x 30cm)
- Peri/vag. aperture: 5" x 6" (12cm x 15.5cm)
- Leggings: 46" (117cm)
- 4 – Tube organizers (ref.1115)

**1032NS** (non-sterile) *Custom Packs Only* 20 ea/cs

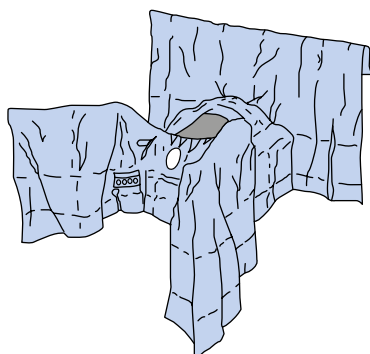

### 2065 Abdominoperineal Incise Drape

Overall Size	Drapes/Box	Boxes/Case
77" x 160" (195cm x 271cm)	8	2

- Steri-Drape 2 incise area: 16" x 17.5" (41cm x 45cm)
- Peri/vag. aperture: 4.5" x 6" (12cm x 15.5cm)
- Tube and cord organizers (ref.1115)

**2065NS** (non-sterile) *Custom Packs Only* 20 ea/cs

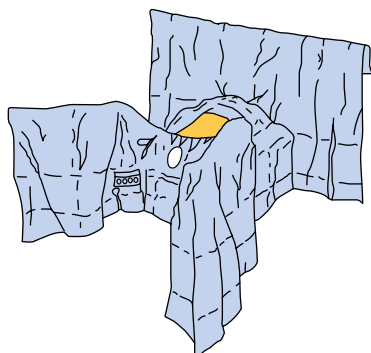

### 6665 Abdominal-Perineal Drape with loban 2 Incise Film – Lithotomy Position

Overall Size	Drapes/Box	Boxes/Case
78" x 107" (200cm x 274cm)	5	1

- loban 2 antimicrobial incise area: 13" x 17" (33cm x 45cm)
- Peri/vag. aperture: 5" x 6" (12cm x 15.5cm)
- Tube and cord organizers (ref.1115)

## KEY

 Absorbent Prevention Fabric

 Standard Blue Fabric (fluid-repellent)

 Clear plastic film

 3M™ loban™ 2 Antimicrobial Incise Film

 3M™ Steri-Drape™ 2 Incise Film

 Adhesive area



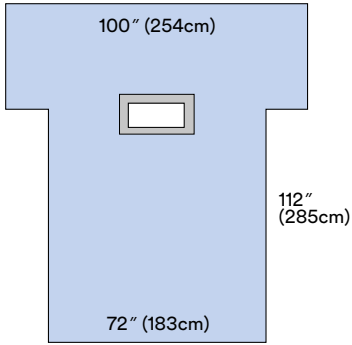

### 9062 Laparotomy Drape (Transverse)

Overall Size	Drapes/Box	Boxes/Case
72" x 112" (183cm x 285cm)	12	2

- Aperture: 12" x 4" (30cm x 10cm)

<b>9062NS</b> (non-sterile) <i>Custom Packs Only</i>	30 ea/cs
--	----------

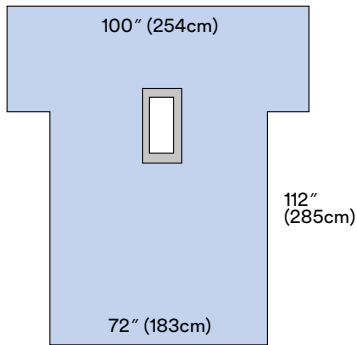

### 9063 Laparotomy Drape

Overall Size	Drapes/Box	Boxes/Case
100" x 112" (254cm x 285cm)	10	2

- Aperture: 4" x 12" (10cm x 30cm)

<b>9063NS</b> (non-sterile) <i>Custom Packs Only</i>	30 ea/cs
--	----------

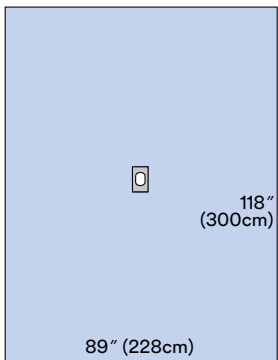

### 9050 Adhesive Aperture Drape

Overall Size	Drapes/Box	Boxes/Case
89" x 118" (228cm x 300cm)	10	2

- Adhesive aperture: 5" x 6" (12cm x 16cm)

<b>9050NS</b> (non-sterile) <i>Custom Packs Only</i>	30 ea/cs
--	----------

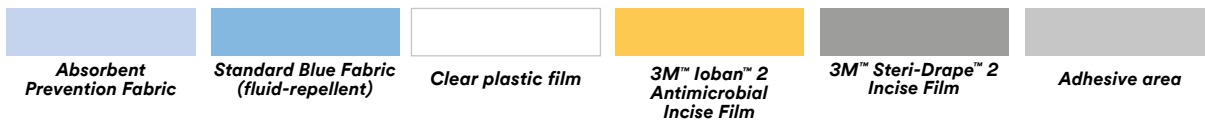

# 3M™ Steri-Drape™

## GENERAL SURGERY DRAPES

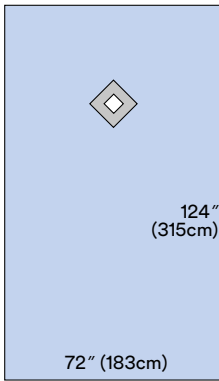

### 9051 Thyroid Drape

Overall Size	Drapes/Box	Boxes/Case
<ul style="list-style-type: none"> <li>Adhesive diamond aperture: 5" x 5" (12cm x 12cm)</li> <li>Adhesive aperture: 5" x 6" (12cm x 16cm)</li> </ul>	10	2
<b>9051NS</b> (non-sterile) <i>Custom Packs Only</i>	34 ea/cs	

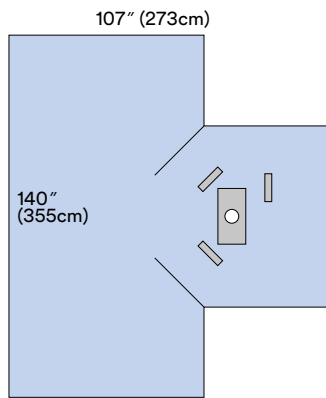

### 9052 Hand Drape

Overall Size	Drapes/Box	Boxes/Case
140" x 115" (355cm x 293cm)	9	2
<ul style="list-style-type: none"> <li>Elastic circle aperture: 1" (3cm)</li> <li>3 – Tube and cord organizers</li> </ul>		
<b>9052NS</b> (non-sterile) <i>Custom Packs Only</i>	20 ea/cs	

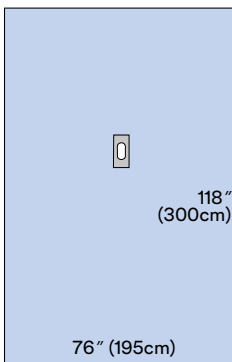

### 9054 Hand and Foot Drape

Overall Size	Drapes/Box	Boxes/Case
76" x 118" (195cm x 300cm)	15	2
<ul style="list-style-type: none"> <li>Elastic aperture: 1" (3cm)</li> </ul>		
<b>9054NS</b> (non-sterile) <i>Custom Packs Only</i>	30 ea/cs	

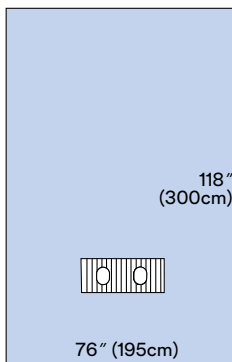

### 9056 Bilateral Foot Drape

Overall Size	Drapes/Box	Boxes/Case
76" x 118" (195cm x 300cm)	13	2
<ul style="list-style-type: none"> <li>Elastic apertures: 2" (4cm)</li> </ul>		
<b>9056NS</b> (non-sterile) <i>Custom Packs Only</i>	28 ea/cs	

## KEY

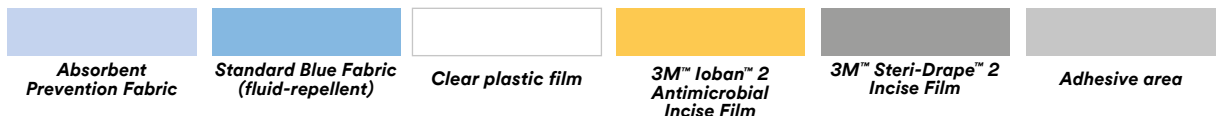

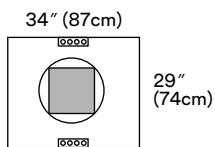

### 2057 Incise Pouch

Overall Size	Drapes/Box	Boxes/Case
34" x 29" (87cm x 74cm)	10	4
<ul style="list-style-type: none"> <li>• Incise area: 12" x 12" (30cm x 30cm)</li> <li>• 360-degree fluid collection pouch</li> <li>• Tube and cord organizers</li> </ul>		
<b>2057NS</b> (non-sterile) <i>Custom Packs Only</i>	100 ea/cs	

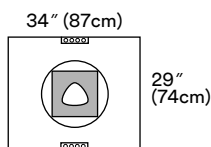

### 2058 Aperture Pouch Drape

Overall Size	Drapes/Box	Boxes/Case
34" x 29" (87cm x 74cm)	10	4
<ul style="list-style-type: none"> <li>• Aperture incise area: 12" x 12" (30cm x 30cm)</li> <li>• 360-degree fluid collection pouch</li> <li>• Tube and cord organizers</li> </ul>		
<b>2058NS</b> (non-sterile) <i>Custom Packs Only</i>	100 ea/cs	

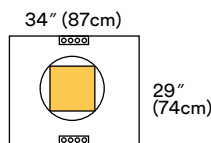

### 6657 Pouch with loban 2 Incise Film

Overall Size	Drapes/Box	Boxes/Case
34" x 29" (87cm x 74cm)	10	4
<ul style="list-style-type: none"> <li>• loban 2 antimicrobial incise area: 11" x 11" (30cm x 30cm)</li> <li>• 360-degree fluid collection pouch</li> <li>• Tube and cord organizers</li> </ul>		

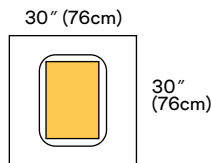

### 6658 Pouch with loban 2 Incise Film, Large

Overall Size	Drapes/Box	Boxes/Case
30" x 30" (76cm x 76cm)	5	4
<ul style="list-style-type: none"> <li>• loban 2 antimicrobial incise area: 13" x 17" (33cm x 43cm)</li> <li>• 360-degree fluid collection pouch</li> </ul>		

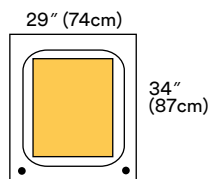

### 6659 Pouch with loban 2 Incise Film, Extra Large

Overall Size	Drapes/Box	Boxes/Case
29" x 34" (74cm x 87cm)	5	4
<ul style="list-style-type: none"> <li>• loban 2 antimicrobial incise area: 16" x 20" (42cm x 52cm)</li> <li>• 360-degree fluid collection pouch</li> <li>• 2 - Exit ports</li> </ul>		



# 3M™ Steri-Drape™

## GENERAL SURGERY DRAPES

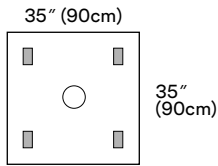

### 1073 Wound Edge Protector

Overall Size	Drapes/Box	Boxes/Case
35" x 35" (90cm x 90cm)	10	4
<ul style="list-style-type: none"> <li>• Ring diameter: 5" (12cm)</li> <li>• 4 – Adhesive patches</li> </ul>		

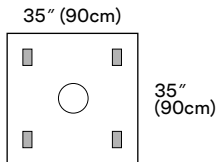

### 1074 Wound Edge Protector

Overall Size	Drapes/Box	Boxes/Case
35" x 35" (90cm x 90cm)	10	4
<ul style="list-style-type: none"> <li>• Ring diameter: 7" (17cm)</li> <li>• 4 – Adhesive patches</li> </ul>		

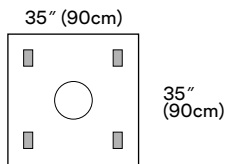

### 1075 Wound Edge Protector

Overall Size	Drapes/Box	Boxes/Case
35" x 35" (90cm x 90cm)	10	4
<ul style="list-style-type: none"> <li>• Ring diameter: 9" (22cm)</li> <li>• 4 – Adhesive patches</li> </ul>		

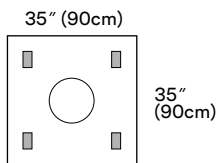

### 1076 Wound Edge Protector

Overall Size	Drapes/Box	Boxes/Case
35" x 35" (90cm x 90cm)	10	4
<ul style="list-style-type: none"> <li>• Ring diameter: 10" (27cm)</li> <li>• 4 – Adhesive patches</li> </ul>		

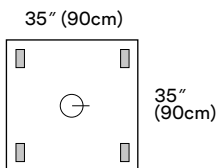

### 1077 Wound Edge Protector

Overall Size	Drapes/Box	Boxes/Case
35" x 35" (90cm x 90cm)	10	4
<ul style="list-style-type: none"> <li>• Ring diameter: 3" (8cm)</li> <li>• 4 – Adhesive patches</li> </ul>		

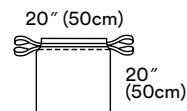

### 1003 Isolation Bag

Overall Size	Drapes/Box	Boxes/Case
20" x 20" (50cm x 50cm)	10	4
<ul style="list-style-type: none"> <li>• Drawstring closure</li> </ul>		

**1003NS** (non-sterile) *Custom Packs Only*

200 ea/cs

## KEY

 Absorbent Prevention Fabric

 Standard Blue Fabric (fluid-repellent)

 Clear plastic film

 3M™ Ioban™ 2 Antimicrobial Incise Film

 3M™ Steri-Drape™ 2 Incise Film

 Adhesive area

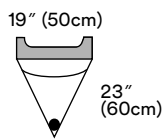

### 1016 Irrigation Pouch

Overall Size	Drapes/Box	Boxes/Case
19" x 23" (50cm x 60cm)	10	4
<ul style="list-style-type: none"> <li>• Adhesive strip</li> <li>• 1 – Exit port</li> <li>• Screen</li> </ul>		
<b>1016NS</b> (non-sterile) <i>Custom Packs Only</i>	200 ea/cs	

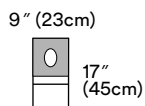

### 1072 Aperture Pouch Drape

Overall Size	Packs/Box	Boxes/Case
9" x 17" (23cm x 45cm)	10	4
<ul style="list-style-type: none"> <li>• Adhesive area: 9" x 10" (23cm x 25cm)</li> <li>• Oval aperture: 3.5" x 4.25" (9cm x 11cm)</li> <li>• Fluid collection pouch</li> </ul>		
<b>1072NS</b> (non-sterile) <i>Custom Packs Only</i>	200 ea/cs	

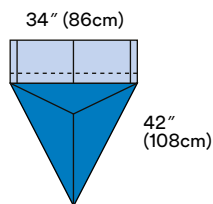

### 1084 Under Buttocks Drape with Pouch

Overall Size	Drapes/Box	Boxes/Case
34" x 42" (86cm x 108cm)	30	4
<ul style="list-style-type: none"> <li>• Cuff size: 10" (25cm)</li> <li>• Fluid collection pouch</li> </ul>		
<b>1084NS</b> (non-sterile) <i>Custom Packs Only</i>	140 ea/cs	



# 3M™ Steri-Drape™ UROLOGY DRAPES

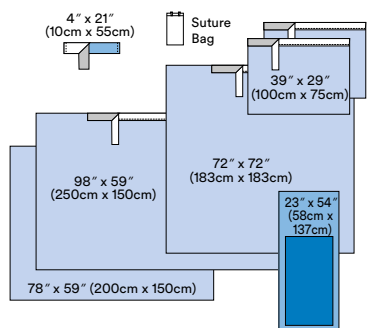

## 9000A Basic Surgical Pack

Name	Quantity	Overall Size	Packs/Box	Boxes/Case
<b>9000A Basic Surgical Pack</b>				
Suture Bag	1		7	2
9099 Operation Tape	1	4" x 21" (10cm x 55cm)		
9036 Mayo Stand Cover	1	23" x 54" (58cm x 137cm)		
9086 Adhesive Towel Drapes	2	39" x 30" (100cm x 76cm)		
9087 Adhesive Drape Sheet (M)	1	72" x 72" (183cm x 183cm)		
9088 Adhesive Drape Sheet (L)	1	98" x 59" (250cm x 150cm)		
9077 Back Table Cover	1	78" x 59" (200cm x 150cm)		

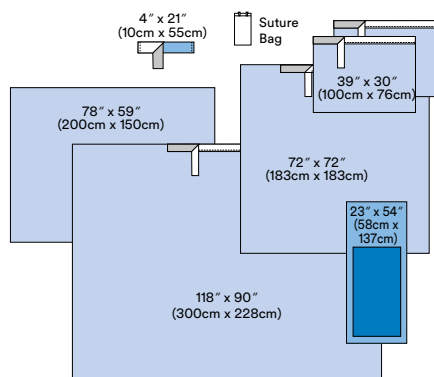

## 9000LA Basic Surgical Pack

Name	Quantity	Overall Size	Packs/Box	Boxes/Case
<b>9000LA Basic Surgical Pack</b>				
Suture Bag	1		5	2
9099 Operation Tape	1	4" x 21" (10cm x 55cm)		
9036 Mayo Stand Cover	1	23" x 54" (58cm x 137cm)		
9086 Adhesive Towel Drapes	2	39" x 30" (100cm x 76cm)		
9087 Adhesive Drape Sheet (M)	1	72" x 72" (183cm x 183cm)		
9090 Adhesive Drape Sheet (XL)	1	118" x 90" (300cm x 228cm)		
9077 Back Table Cover	1	78" x 59" (200cm x 150cm)		

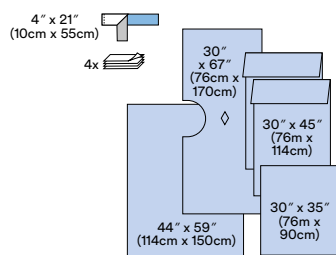

## 9003 Cystoscopy Pack

Name	Quantity	Overall Size	Packs/Box	Boxes/Case
<b>9003 Cystoscopy Pack</b>				
Suture Bag	1		10	2
9099 Operation Tape	1	4" x 21" (10cm x 55cm)		
Hand Towels	4	-		
9040 Leggings (pair)	1	30" x 45" (76cm x 114cm)		
9069 Drape Sheet	1	30" x 35" (76cm x 90cm)		
9023 Perineal Aperture Drape	1	30" x 67" (76cm x 170cm)		
9072 Back Table Cover	1	44" x 59" (114cm x 150cm)		

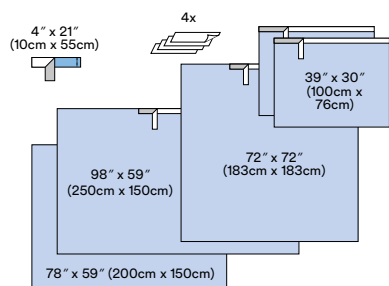

## 9010 Basic Surgical Pack without Mayo Stand Cover

Name	Quantity	Overall Size	Packs/Box	Boxes/Case
<b>9010 Basic Surgical Pack without Mayo Stand Cover</b>				
Suture Bag	1		7	2
9099 Operation Tape	1	4" x 21" (10cm x 55cm)		
Hand Towels	4	-		
9085 Adhesive Towel Drapes	2	39" x 33" (100cm x 85cm)		
9087 Adhesive Drape Sheet (M)	1	72" x 72" (183cm x 183cm)		
9088 Adhesive Drape Sheet (L)	1	98" x 59" (250cm x 150cm)		
9077 Back Table Cover	1	78" x 59" (200cm x 150cm)		

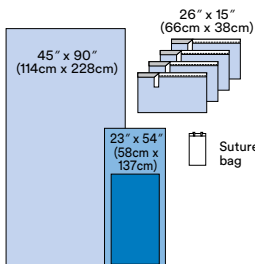

## 9020A Basic Set-Up Pack

Name	Quantity	Overall Size	Packs/Box	Boxes/Case
<b>9020A Basic Set-Up Pack</b>				
Suture Bag	1		20	2
9036 Mayo Stand Cover	1	23" x 54" (58cm x 137cm)		
Utility Drapes	4	26" x 15" (66cm x 38cm)		
Back Table Cover	1	45" x 90" (114cm x 228cm)		

**KEY**

Absorbent  
Prevention Fabric

Standard Blue Fabric  
(fluid-repellent)

Clear plastic film

3M™ Ioban™ 2  
Antimicrobial  
Incise Film

3M™ Steri-Drape™ 2  
Incise Film

Adhesive area



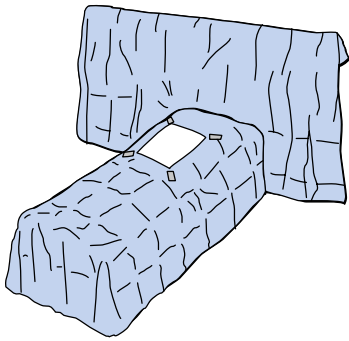

### 1031 Laparoscopic Drape/Supine Position

Overall Size	Drapes/Box	Boxes/Case
112" x 90" (285cm x 228cm)	10	2
<ul style="list-style-type: none"> <li>• Adhesive aperture: 10" x 11" (27cm x 30cm)</li> <li>• 4 – Tube organizers (ref.1115)</li> </ul>		
<b>1031NS</b> (non-sterile) <i>Custom Packs Only</i>	30 ea/cs	

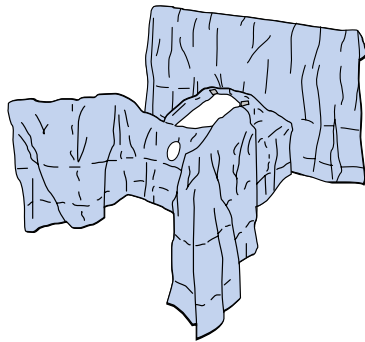

### 1032 Laparoscopic Drape/Lithotomy Position

Overall Size	Drapes/Box	Boxes/Case
95" x 90" (241cm x 228cm)	8	2
<ul style="list-style-type: none"> <li>• Adhesive aperture: 11" x 12" (27cm x 30cm)</li> <li>• Peri/vag. aperture: 5" x 6" (12cm x 15.5cm)</li> <li>• Leggings: 46" (117cm)</li> <li>• 4 – Tube organizers (ref.1115)</li> </ul>		
<b>1032NS</b> (non-sterile) <i>Custom Packs Only</i>	20 ea/cs	

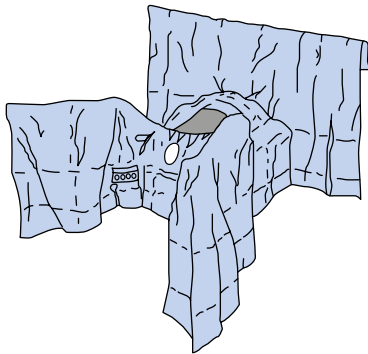

### 2065 Abdominoperineal Incise Drape

Overall Size	Drapes/Box	Boxes/Case
77" x 160" (195cm x 271cm)	8	2
<ul style="list-style-type: none"> <li>• Steri-Drape 2 incise area: 16" x 18" (41cm x 45cm)</li> <li>• Peri/vag. aperture: 5" x 6" (12cm x 15.5cm)</li> <li>• Tube and cord organizers (ref.1115)</li> </ul>		
<b>2065NS</b> (non-sterile) <i>Custom Packs Only</i>	20 ea/cs	

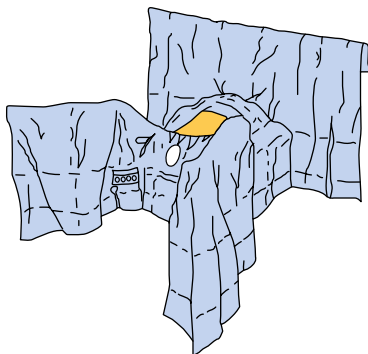

### 6665 Abdominal-Perineal Drape with Ioban 2 Incise Film – Lithotomy Position

Overall Size	Drapes/Box	Boxes/Case
78" x 107" (200cm x 274cm)	5	1
<ul style="list-style-type: none"> <li>• Ioban 2 antimicrobial incise area: 13" x 17" (33cm x 45cm)</li> <li>• Peri/vag. aperture: 5" x 6" (12cm x 16cm)</li> <li>• Tube and cord organizers (ref.1115)</li> </ul>		

Absorbent  
Prevention Fabric

Standard Blue Fabric  
(fluid-repellent)

Clear plastic film

3M™ Ioban™ 2  
Antimicrobial  
Incise Film

3M™ Steri-Drape™ 2  
Incise Film

Adhesive area

KEY

# 3M™ Steri-Drape™

## UROLOGY DRAPES

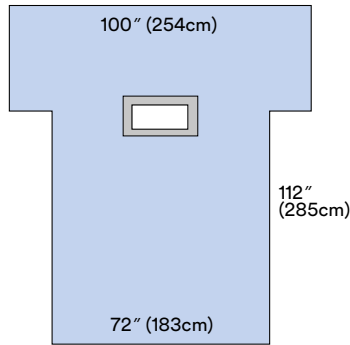

### 9062 Laparotomy Drape (Transverse)

Overall Size	Drapes/Box	Boxes/Case
72" x 112" (183cm x 285cm)	12	2

- Aperture: 12" x 4" (30cm x 10cm)

### 9062NS (non-sterile) Custom Packs Only

30 ea/cs

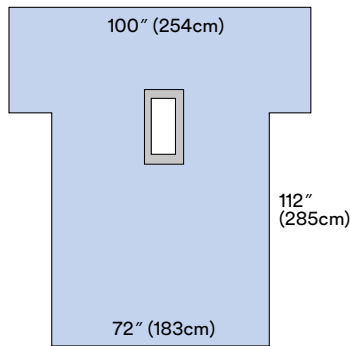

### 9063 Laparotomy Drape

Overall Size	Drapes/Box	Boxes/Case
100" x 112" (254cm x 285cm)	10	2

- Aperture: 4" x 12" (10cm x 30cm)

### 9063NS (non-sterile) Custom Packs Only

30 ea/cs

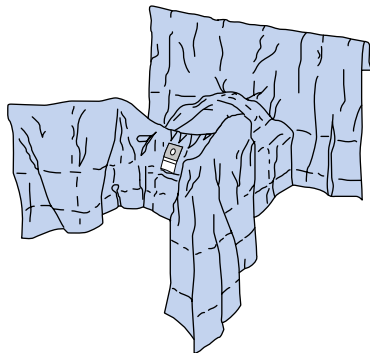

### 1080 Gynaecology Drape

Overall Size	Drapes/Box	Boxes/Case
77" x 70" (195cm x 179cm)	14	2

- Peri/vag. aperture: 4" x 5" (9cm x 12cm)
- Tube and cord organizers (ref.1115)
- Fluid collection pouch (ref.)

### 1080NS (non-sterile) Custom Packs Only

30 ea/cs

Leggings 46" (117cm)

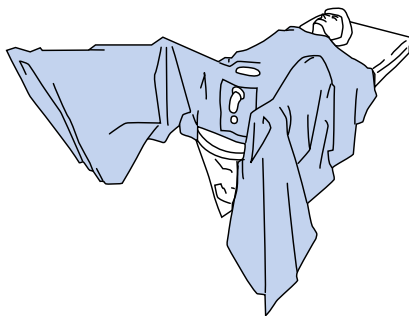

### 1081 TUR/Urological Drape

Overall Size	Drapes/Box	Boxes/Case
Length: 64" (164cm)	14	2
Width at arm extensions: 60" (152cm)		

- Abdominal adhesive aperture: 2" (6cm)
- Elastic aperture
- Non-latex finger cot
- Large integrated fluid collection pouch with filter and exit ports

### 1081NS (non-sterile) Custom Packs Only

30 ea/cs

## KEY

Absorbent  
Prevention Fabric

Standard Blue Fabric  
(fluid-repellent)

Clear plastic film

3M™ Ioban™ 2  
Antimicrobial  
Incise Film

3M™ Steri-Drape™ 2  
Incise Film

Adhesive area

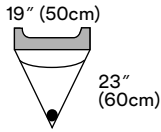

### 1016 Irrigation Pouch

Overall Size	Drapes/Box	Boxes/Case
19" x 23" (50cm x 60cm)	10	4
<ul style="list-style-type: none"> <li>• Adhesive strip</li> <li>• 1 – Exit port</li> <li>• Screen</li> </ul>		
<b>1016NS</b> (non-sterile) <i>Custom Packs Only</i>	200 ea/cs	

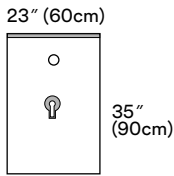

### 1071 Urological Drape

Overall Size	Packs/Box	Boxes/Case
23" x 35" (60cm x 90cm)	10	4
<ul style="list-style-type: none"> <li>• Aperture area: 2" (5cm)</li> <li>• Non-latex finger cot with adhesive</li> <li>• Adhesive strip</li> </ul>		
<b>1071NS</b> (non-sterile) <i>Custom Packs Only</i>	200 ea/cs	

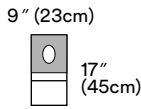

### 1072 Aperture Pouch Drape

Overall Size	Packs/Box	Boxes/Case
9" x 17" (23cm x 45cm)	10	4
<ul style="list-style-type: none"> <li>• Adhesive area: 9" x 10" (23cm x 25cm)</li> <li>• Oval aperture: 3.5" x 4.25" (9cm x 11cm)</li> <li>• Fluid collection pouch</li> </ul>		
<b>1072NS</b> (non-sterile) <i>Custom Packs Only</i>	200 ea/cs	

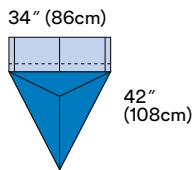

### 1084 Under Buttocks Drape with Pouch

Overall Size	Drapes/Box	Boxes/Case
34" x 42" (86cm x 108cm)	30	4
<ul style="list-style-type: none"> <li>• Cuff size: 10" (25cm)</li> <li>• Fluid collection pouch</li> </ul>		
<b>1084NS</b> (non-sterile) <i>Custom Packs Only</i>	140 ea/cs	

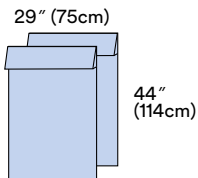

### 9040 Leggings (2)

Overall Size	Drapes/Box	Boxes/Case
29" x 44" (75cm x 114cm)	10	4
<b>9040NS</b> (non-sterile) <i>Custom Packs Only</i>	116 ea/cs	



# 3M™ Steri-Drape™ NEUROLOGY DRAPES

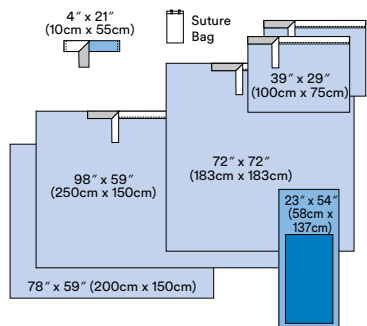

## 9000A Basic Surgical Pack

Name	Quantity	Overall Size	Packs/Box	Boxes/Case
<b>9000A Basic Surgical Pack</b>				
Suture Bag	1		7	2
9099 Operation Tape	1	4" x 21" (10cm x 55cm)		
9036 Mayo Stand Cover	1	23" x 54" (58cm x 137cm)		
9086 Adhesive Towel Drapes	2	39" x 30" (100cm x 76cm)		
9087 Adhesive Drape Sheet (M)	1	72" x 72" (183cm x 183cm)		
9088 Adhesive Drape Sheet (L)	1	98" x 59" (250cm x 150cm)		
9077 Back Table Cover	1	78" x 59" (200cm x 150cm)		

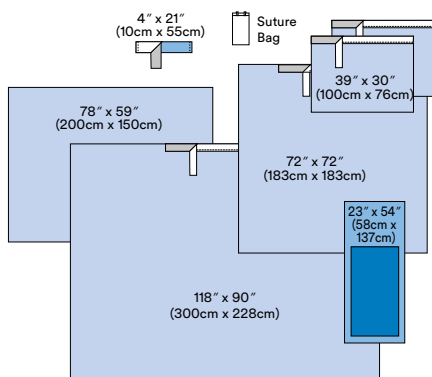

## 9000LA Basic Surgical Pack

Name	Quantity	Overall Size	Packs/Box	Boxes/Case
<b>9000LA Basic Surgical Pack</b>				
Suture Bag	1		5	2
9099 Operation Tape	1	4" x 21" (10cm x 55cm)		
9036 Mayo Stand Cover	1	23" x 54" (58cm x 137cm)		
9086 Adhesive Towel Drapes	2	39" x 30" (100cm x 76cm)		
9087 Adhesive Drape Sheet (M)	1	72" x 72" (183cm x 183cm)		
9090 Adhesive Drape Sheet (XL)	1	118" x 90" (300cm x 228cm)		
9077 Back Table Cover	1	78" x 59" (200cm x 150cm)		

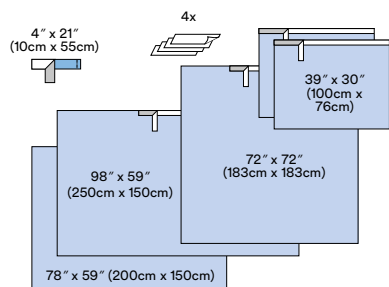

## 9010 Basic Surgical Pack without Mayo Stand Cover

Name	Quantity	Overall Size	Packs/Box	Boxes/Case
<b>9010 Basic Surgical Pack without Mayo Stand Cover</b>				
9099 Operation Tape	1	4" x 21" (10cm x 55cm)	7	2
Hand Towels	4	-		
9085 Adhesive Towel Drapes	2	39" x 33" (100cm x 85cm)		
9087 Adhesive Drape Sheet (M)	1	72" x 72" (183cm x 183cm)		
9088 Adhesive Drape Sheet (L)	1	98" x 59" (250cm x 150cm)		
9077 Back Table Cover	1	78" x 59" (200cm x 150cm)		

### KEY

 Absorbent Prevention Fabric

 Standard Blue Fabric (fluid-repellent)

 Clear plastic film

 3M™ Ioban™ 2 Antimicrobial Incise Film

 3M™ Steri-Drape™ 2 Incise Film

 Adhesive area

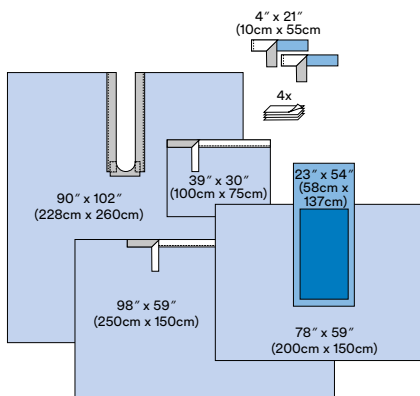

### 9018A Surgical Split Sheet Pack

Name	Quantity	Overall Size	Packs/Box	Boxes/Case
<b>9018A Surgical Split Sheet Pack</b>				
9099 Operation Tape	2	4" x 21" (10cm x 55cm)	6	2
9036 Mayo Stand Cover	1	23" x 54" (58cm x 137cm)		
9086 Adhesive Towel Drape	1	39" x 30" (100cm x 76cm)		
9045 Adhesive Split Sheet	1	90" x 102" (228cm x 260cm)		
9088 Adhesive Drape Sheet (L)	1	98" x 59" (250cm x 150cm)		
9077 Back Table Cover	1	78" x 59" (200cm x 150cm)		

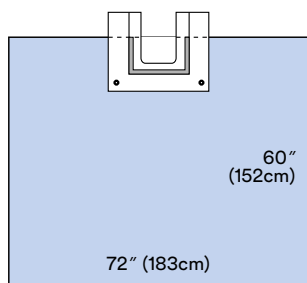

### 9047 Neuro Split Sheet with Pouch

Overall Size	Drapes/Box	Boxes/Case
72" x 60" (183cm x 152cm)	15	2
<ul style="list-style-type: none"> <li>• Adhesive split: 6" x 15" (16cm x 40cm)</li> <li>• Fluid collection pouch (ref. 1067)</li> <li>• 2 – Exit ports</li> </ul>		
<b>9047NS</b> (non-sterile) <i>Custom Packs Only</i>	32 ea/cs	

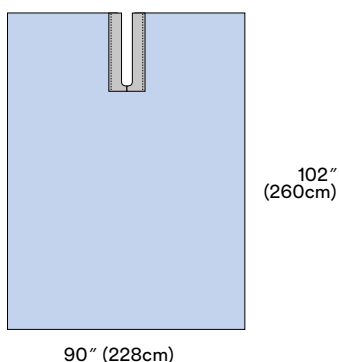

### 9048 Adhesive Split Sheet

Overall Size	Drapes/Box	Boxes/Case
90" x 102" (228cm x 260cm)	15	2
<ul style="list-style-type: none"> <li>• Adhesive split: 7" x 15" (20cm x 40cm)</li> </ul>		
<b>9048NS</b> (non-sterile) <i>Custom Packs Only</i>	32 ea/cs	

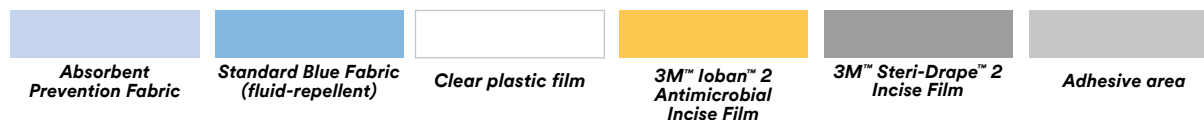

# 3M™ Steri-Drape™

## NEUROLOGY DRAPES

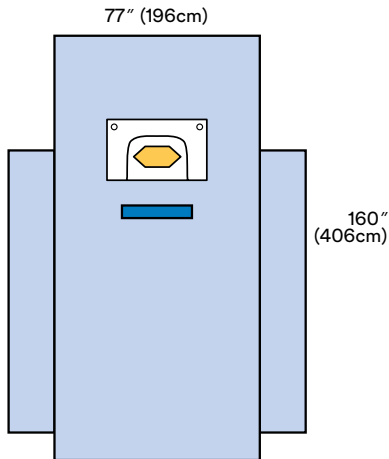

### 6687 Craniotomy Drape with loban 2 Incise Pouch

Overall Size	Drapes/Box	Boxes/Case
77" x 160" (196cm x 406cm)	10	1

- Incise area: 15" x 8" (36.8cm x 21.4cm)
- Large rectangular fluid collection pouch
- Reinforced plastic strip with a wide adhesive secular

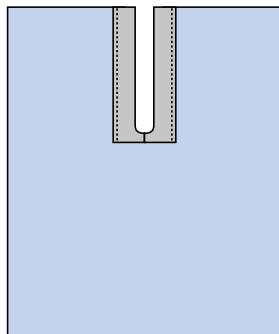

### Adhesive Split Sheets

	Overall Size	Split Size	Drapes/Box	Boxes/Case
<b>9043</b>	60" x 72" (152cm x 183cm)	2.5" x 25" (7x70cm)	30	2
<b>9044</b>	60" x 98" (152cm x 250cm)	2.5" x 25" (7x70cm)	25	2
<b>9045</b>	90" x 102" (228cm x 260cm)	8" x 39" (20cm x 100cm)	15	2
<b>9043NS</b> (non-sterile) <i>Custom Packs Only</i>			68 ea/cs	
<b>9044NS</b> (non-sterile) <i>Custom Packs Only</i>			58 ea/cs	
<b>9045NS</b> (non-sterile) <i>Custom Packs Only</i>			30 ea/cs	

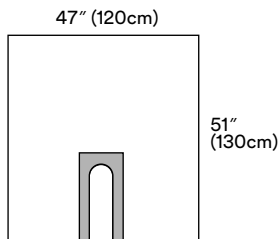

### 1015 U-drape

Overall Size	Drapes/Box	Boxes/Case
47" x 51" (120m x 130cm)	10	4

- Adhesive split: 7" x 18" (16.5cm x 46cm)

<b>1015NSD</b> (non-sterile)	100 ea/cs
<b>1015NS</b> (non-sterile) <i>Custom Packs Only</i>	200 ea/cs

## KEY

Absorbent Prevention Fabric

Standard Blue Fabric (fluid-repellent)

Clear plastic film

3M™ Ioban™ 2 Antimicrobial Incise Film

3M™ Steri-Drape™ 2 Incise Film

Adhesive area

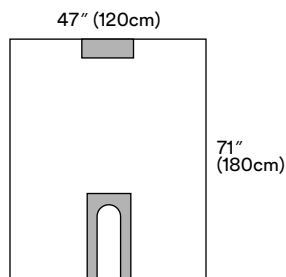

### 1019 Long U-drape

Overall Size	Drapes/Box	Boxes/Case
47" x 71" (120cm x 180cm)	10	4
<ul style="list-style-type: none"> <li>• Adhesive split: 7" x 18" (16.5cm x 46cm)</li> <li>• Adhesive patch</li> </ul>		
<b>1019NS</b> (non-sterile) <i>Custom Packs Only</i>	200 ea/cs	

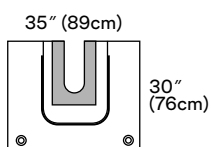

### 1067 U-pouch

Overall Size	Drapes/Box	Boxes/Case
35" x 30" (89cm x 76cm)	5	4
<ul style="list-style-type: none"> <li>• Adhesive split: 6" x 15" (16cm x 40cm)</li> <li>• Fluid collection pouch</li> <li>• 2 – Exit ports</li> </ul>		
<b>1067NS</b> (non-sterile) <i>Custom Packs Only</i>	50 ea/cs	

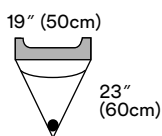

### 1016 Irrigation Pouch

Overall Size	Drapes/Box	Boxes/Case
19" x 23" (50cm x 60cm)	10	4
<ul style="list-style-type: none"> <li>• Adhesive strip</li> <li>• 1 – Exit port</li> <li>• Screen</li> </ul>		
<b>1016NS</b> (non-sterile) <i>Custom Packs Only</i>	200 ea/cs	



# SURGICAL SHEETS AND ACCESSORIES

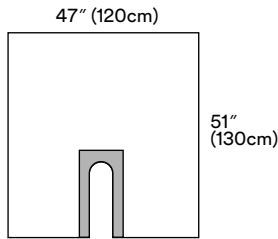

## 1015 U-drape

Overall Size	Drapes/Box	Boxes/Case
47" x 51" (120cm x 130cm)	10	4
<ul style="list-style-type: none"> <li>• Adhesive split: 6½" x 18" (16.5cm x 46cm)</li> </ul>		
<b>1015NSD</b> (non-sterile)	100 ea/cs	
<b>1015NS</b> (non-sterile) <i>Custom Packs Only</i>	200 ea/cs	

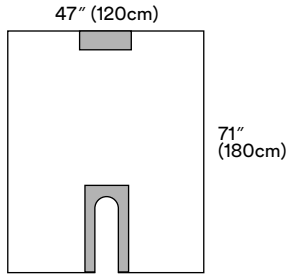

## 1019 Long U-drape

Overall Size	Drapes/Box	Boxes/Case
47" x 71" (120cm x 180cm)	10	4
<ul style="list-style-type: none"> <li>• Adhesive split: 6½" x 18" (16.5cm x 46cm)</li> <li>• Adhesive patch</li> </ul>		
<b>1019NS</b> (non-sterile) <i>Custom Packs Only</i>	200 ea/cs	

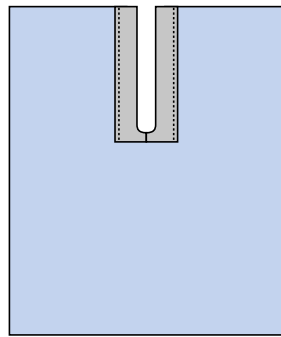

## Adhesive Split Sheets

	Overall Size	Split Size	Drapes/Box	Boxes/Case
<b>9043</b>	60" x 72" (152cm x 183cm)	2.5" x 25" (7x70cm)	30	2
<b>9044</b>	60" x 98" (152cm x 250cm)	2.5" x 25" (7x70cm)	25	2
<b>9045</b>	90" x 102" (228cm x 260cm)	8" x 39" (20cm x 100cm)	15	2
<b>9043NS</b> (non-sterile) <i>Custom Packs Only</i>			68 ea/cs	
<b>9044NS</b> (non-sterile) <i>Custom Packs Only</i>			58 ea/cs	
<b>9045NS</b> (non-sterile) <i>Custom Packs Only</i>			30 ea/cs	

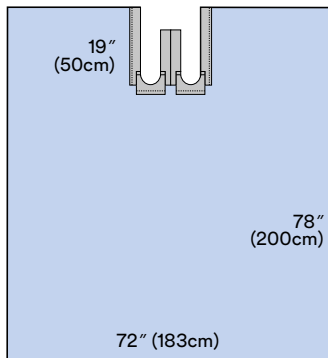

## 9046 Bilateral Adhesive Split Sheet

Overall Size	Drapes/Box	Boxes/Case
72" x 78" (183cm x 200cm)	15	2
<ul style="list-style-type: none"> <li>• Double adhesive split: 5⅞" x 19" (15cm x 50cm)</li> </ul>		
<b>9046NS</b> (non-sterile) <i>Custom Packs Only</i>	30 ea/cs	

### KEY

Absorbent Prevention Fabric

Standard Blue Fabric (fluid-repellent)

Clear plastic film

3M™ Ioban™ 2 Antimicrobial Incise Film

3M™ Steri-Drape™ 2 Incise Film

Adhesive area



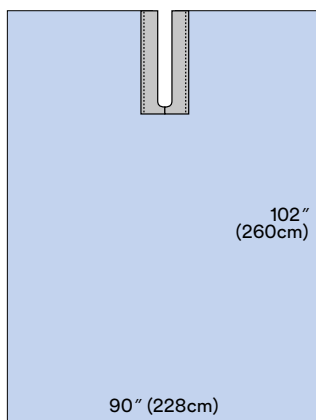

### 9048 Adhesive Split Sheet

Overall Size	Drapes/Box	Boxes/Case
90" x 102" (228cm x 260cm)	15	2
<ul style="list-style-type: none"> <li>Adhesive split: 7" x 15" (20cm x 40cm)</li> </ul>		
<b>9048NS</b> (non-sterile) <i>Custom Packs Only</i>	32 ea/cs	

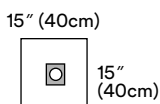

### 1020 Small Drape with Adhesive Aperture

Overall Size	Drapes/Box	Boxes/Case
15" x 15" (40cm x 40cm)	10	4
<ul style="list-style-type: none"> <li>Adhesive area: 4" x 5" (10cm x 12.5cm)</li> <li>Circle aperture: 2<sup>3</sup>/<sub>8</sub>" (6.3cm)</li> </ul>		
<b>1020NS</b> (non-sterile) <i>Custom Packs Only</i>	200 ea/cs	

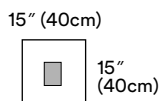

### 1021 Small Drape with Incise Film

Overall Size	Drapes/Box	Boxes/Case
15" x 15" (40cm x 40cm)	10	4
<ul style="list-style-type: none"> <li>Incise area: 4" x 5" (10cm x 12.5cm)</li> </ul>		
<b>1021NS</b> (non-sterile) <i>Custom Packs Only</i>	200 ea/cs	

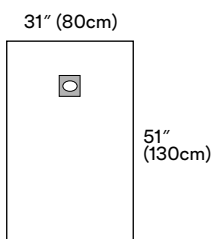

### 1030 Medium Drape with Adhesive Aperture

Overall Size	Drapes/Box	Boxes/Case
31" x 51" (80cm x 130cm)	10	4
<ul style="list-style-type: none"> <li>Adhesive area: 3<sup>7</sup>/<sub>8</sub>" x 4<sup>7</sup>/<sub>8</sub>" (10cm x 12.5cm)</li> <li>Oval aperture: 2" x 2<sup>7</sup>/<sub>8</sub>" (5.2cm x 7.6cm)</li> </ul>		
<b>1030NS</b> (non-sterile) <i>Custom Packs Only</i>	200 ea/cs	

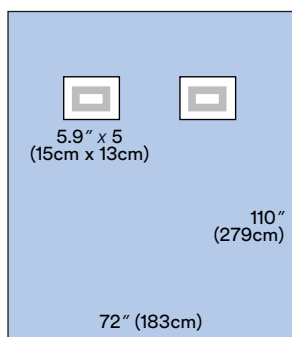

### 1135 PICC Drape with Adhesive Aperture

Overall Size	Drapes/Box	Boxes/Case
72" x 110" (183cm x 279cm)	15	2
<ul style="list-style-type: none"> <li>Adhesive area: 5.9" x 5" (15cm x 13cm)</li> <li>Film window with adhesive</li> <li>Breakaway seams for left and right access sites</li> </ul>		



Absorbent  
Prevention Fabric



Standard Blue Fabric  
(fluid-repellent)



Clear plastic film



3M™ Ioban™ 2  
Antimicrobial  
Incise Film



3M™ Steri-Drape™ 2  
Incise Film

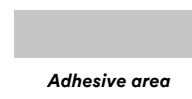

Adhesive area

KEY

# SURGICAL SHEETS AND ACCESSORIES

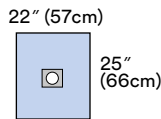

## 1092 Small Drape with Adhesive Aperture

Overall Size	Drapes/Box	Boxes/Case
22" x 25" (57cm x 66cm)	25	4
Adhesive area: 3 <sup>7</sup> / <sub>8</sub> " x 3 <sup>7</sup> / <sub>8</sub> " (10cm x 10cm)		
Circle aperture: 2.25" (6cm)		
<b>1092NS</b> (non-sterile) <i>Custom Packs Only</i>	500 ea/cs	

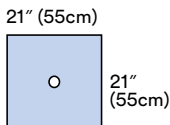

## 9026 Aperture Drape

Overall Size	Drapes/Box	Boxes/Case
21" x 21" (55cm x 55cm)	100	4
• Aperture: 2" x 3" (6cm x 8cm)		
<b>9026NS</b> (non-sterile) <i>Custom Packs Only</i>	700 ea/cs	

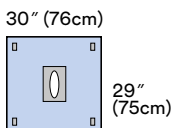

## 9029 Adhesive Aperture Drape

Overall Size	Drapes/Box	Boxes/Case
30" x 29" (76cm x 75cm)	40	4
• Adhesive aperture: 6" x 2" (15cm x 6cm)		
<b>9029NS</b> (non-sterile) <i>Custom Packs Only</i>	300 ea/cs	

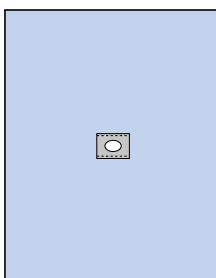

## Adhesive Aperture Drape

	Overall Size	Drapes/Box	Boxes/Case
<i>Centered Aperture</i>			
<b>9030</b>	47" x 60" (120cm x 152cm)	20	4
<i>Off-Centered Aperture</i>			
<b>9031</b>	59" x 72" (150cm x 183cm)	25	2
• Adhesive aperture: 2" x 3" (6cm x 8cm)			
<b>9030NS</b> (non-sterile) <i>Custom Packs Only</i>	115 ea/cs		
<b>9031NS</b> (non-sterile) <i>Custom Packs Only</i>	80 ea/cs		

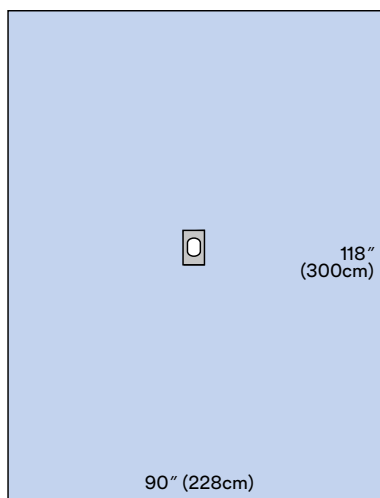

## 9050 Adhesive Aperture Drape

Overall Size	Drapes/Box	Boxes/Case
89" x 118" (228cm x 300cm)	10	2
• Adhesive aperture: 5" x 6" (12cm x 16cm)		
<b>9050NS</b> (non-sterile) <i>Custom Packs Only</i>	30 ea/cs	

### KEY

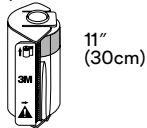

25 yds (22m)

**1000Disp Roll Prep Drape**

Roll Size	Rolls/Case	Dispenser/Case
25 yds. x 11" (22m x 30cm)	1	1

- Adhesive strip
- Non-sterile

25 yds (22m)

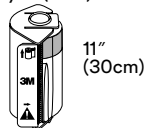
**1000NSR Roll Prep Drape**

Roll Size	Rolls/Case	Dispenser/Case
25 yds. x 11" (22m x 30cm)	8	1

- Adhesive strip
- Non-sterile

17" (45cm)

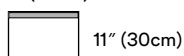
**1000 Small Towel Drape**

Overall Size	Drapes/Box	Boxes/Case
17" x 11" (45cm x 30cm)	10	4

- Adhesive strip

<b>1000NSD</b> (non-sterile)	100	1
------------------------------	-----	---

<b>1000NS</b> (non-sterile) <i>Custom Packs Only</i>	200 ea/cs	
--	-----------	--

17" (45cm)

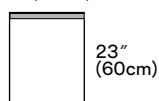
**1010 Large Towel Drape**

Overall Size	Drapes/Box	Boxes/Case
17" x 23" (45cm x 60cm)	10	4

- Adhesive strip

<b>91010SD</b> (non-sterile)	100	1
------------------------------	-----	---

<b>1010NS</b> (non-sterile) <i>Custom Packs Only</i>	300 ea/cs	
--	-----------	--

29" (75cm)

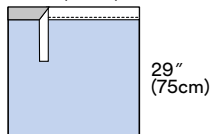
**9084 Adhesive Towel Drape**

Overall Size	Drapes/Box	Boxes/Case
29" x 29" (75cm x 75cm)	40	4

<b>9084NS</b> (non-sterile) <i>Custom Packs Only</i>	275 ea/cs	
--	-----------	--

39" (100cm)

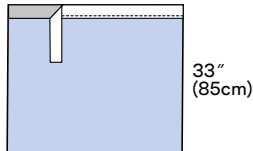
**9085 Adhesive Towel Drape**

Overall Size	Drapes/Box	Boxes/Case
39" x 33" (100cm x 85cm)	30	4

<b>9085NS</b> (non-sterile) <i>Custom Packs Only</i>	160 ea/cs	
--	-----------	--

Absorbent  
Prevention FabricStandard Blue Fabric  
(fluid-repellent)

Clear plastic film

3M™ Ioban™ 2  
Antimicrobial  
Incise Film3M™ Steri-Drape™ 2  
Incise Film

Adhesive area

KEY

# SURGICAL SHEETS AND ACCESSORIES

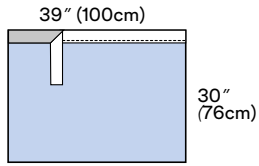

## 9086 Adhesive Towel Drape

Overall Size	Drapes/Box	Boxes/Case
39" x 30" (100cm x 76cm)	40	4
<b>9086NS</b> (non-sterile) <i>Custom Packs Only</i>	180 ea/cs	

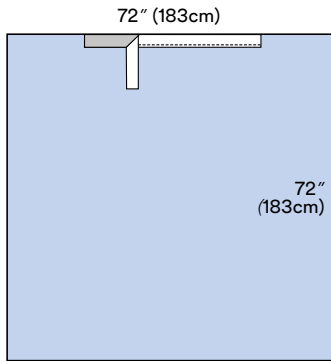

## 9087 Adhesive Drape Sheets

Overall Size	Drapes/Box	Boxes/Case
72" x 72" (183cm x 183cm)	25	2
<b>9087NS</b> (non-sterile) <i>Custom Packs Only</i>	50 ea/cs	

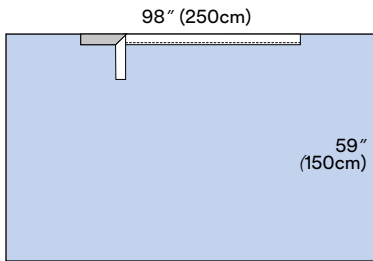

## 9088 Adhesive Drape Sheets

Overall Size	Drapes/Box	Boxes/Case
98" x 59" (250cm x 150cm)	25	2
<b>9088NS</b> (non-sterile) <i>Custom Packs Only</i>	50 ea/cs	

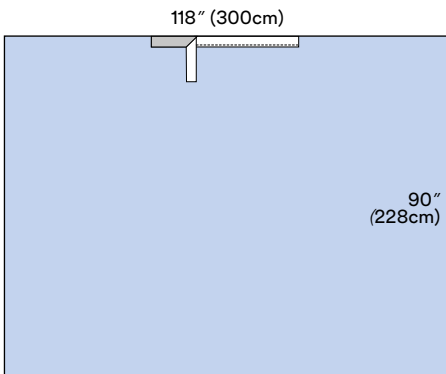

## 9090 Adhesive Drape Sheets

Overall Size	Drapes/Box	Boxes/Case
118" x 90" (300cm x 228cm)	12	2
<b>9090NS</b> (non-sterile) <i>Custom Packs Only</i>	20 ea/cs	

Surgical Sheets

### KEY

 Absorbent Prevention Fabric

 Standard Blue Fabric (fluid-repellent)

 Clear plastic film

 3M™ Ioban™ 2 Antimicrobial Incise Film

 3M™ Steri-Drape™ 2 Incise Film

 Adhesive area

22" (57cm)

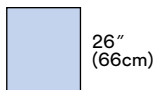
26"  
(66cm)**1089 Utility Sheet (2)**

Overall Size	Drapes/Package	Packages/Box	Boxes/Case
22" x 26" (57cm x 66cm)	2	80	1
<b>1089NS</b> (non-sterile) <i>Custom Packs Only</i>		200 ea/cs	

35.5" (90cm)

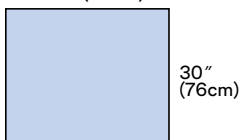
30"  
(76cm)**9069 Drape Sheet**

Overall Size	Drapes/Box	Boxes/Case
35.5" x 30" (90cm x 76cm)	50	4
<b>9069NS</b> (non-sterile) <i>Custom Packs Only</i>		300 ea/cs

44" (114cm)

59"  
(150cm)**9072 Back Table Cover**

Overall Size	Drapes/Box	Boxes/Case
44" x 59" (114cm x 150cm)	20	4
<b>9072NS</b> (non-sterile) <i>Custom Packs Only</i>		90 ea/cs

78" (200cm)

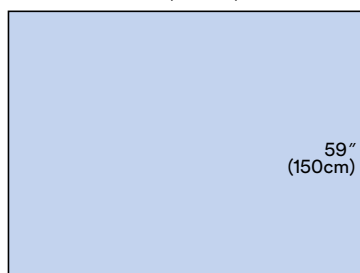
59"  
(150cm)**9077 Back Table Cover**

Overall Size	Drapes/Box	Boxes/Case
78" x 59" (200cm x 152cm)	30	2
<b>9077NS</b> (non-sterile) <i>Custom Packs Only</i>		60 ea/cs

78" (200cm)

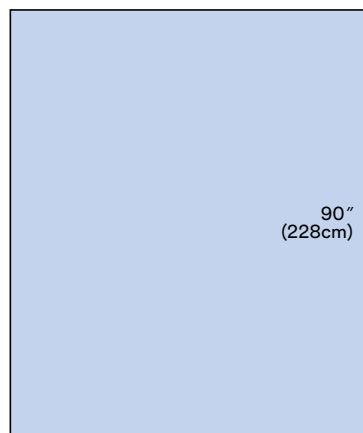
90"  
(228cm)**9079 Back Table Cover**

Overall Size	Drapes/Box	Boxes/Case
78" x 90" (200cm x 228cm)	20	2
<b>9079NS</b> (non-sterile) <i>Custom Packs Only</i>		44 ea/cs

Absorbent  
Prevention FabricStandard Blue Fabric  
(fluid-repellent)

Clear plastic film

3M™ Ioban™ 2  
Antimicrobial  
Incise Film3M™ Steri-Drape™ 2  
Incise Film

Adhesive area

KEY

# SURGICAL SHEETS AND ACCESSORIES

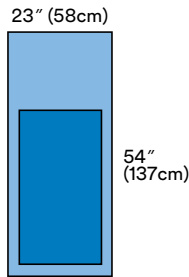

## 9036 Mayo Stand Cover

Overall Size	Drapes/Box	Boxes/Case
23" x 54" (58cm x 137cm)	60	4

- Blue plastic with nonwoven pad

<b>9036NS</b> (non-sterile) <i>Custom Packs Only</i>	300 ea/cs
--	-----------

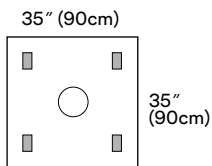

## Wound Edge Protectors

	Overall Size	Ring Diameter	Drapes/Box	Boxes/Case
<b>1073</b>	35" x 35" (90cm x 90cm)	4 <sup>3</sup> / <sub>4</sub> " (12cm)	10	4
<b>1074</b>	35" x 35" (90cm x 90cm)	6 <sup>5</sup> / <sub>8</sub> " (17cm)	10	4
<b>1075</b>	35" x 35" (90cm x 90cm)	8 <sup>5</sup> / <sub>8</sub> " (22cm)	10	4
<b>1076</b>	35" x 35" (90cm x 90cm)	10" (27cm)	10	4
<b>1077</b>	35" x 35" (90cm x 90cm)	3" (7.8cm)	10	4

- 4 – Adhesive patches

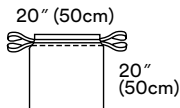

## 1003 Isolation Bag

Overall Size	Drapes/Box	Boxes/Case
20" x 20" (50cm x 50cm)	10	4

- Drawstring closure

<b>1003NS</b> (non-sterile) <i>Custom Packs Only</i>	200 ea/cs
--	-----------

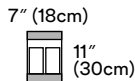

## 1018 Instrument Pouch

Overall Size	Drapes/Box	Boxes/Case
7" x 11" (18cm x 30cm)	10	4

- 2 – Adhesive strips
- 2 – Compartments

<b>1018NS</b> (non-sterile) <i>Custom Packs Only</i>	200 ea/cs
--	-----------

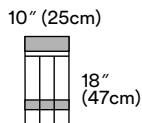

## 1018L Long Instrument Pouch

Overall Size	Drapes/Box	Boxes/Case
10" x 18" (25cm x 47cm)	10	4

- 2 – Adhesive strips
- 3 – Compartments

<b>1018LNS</b> (non-sterile) <i>Custom Packs Only</i>	200 ea/cs
---	-----------

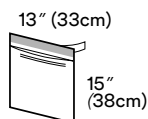

## 9097 Instrument Pouch (L)

Overall Size	Drapes/Box	Boxes/Case
13" x 15" (33cm x 38cm)	100	2

<b>9097NS</b> (non-sterile) <i>Custom Packs Only</i>	336 ea/cs
--	-----------

### KEY

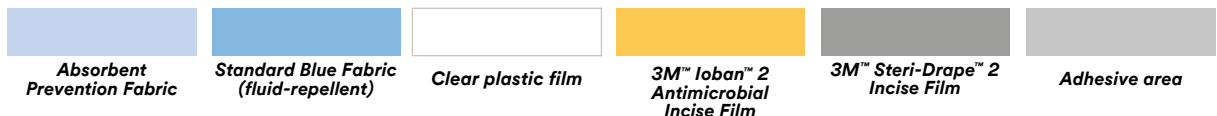

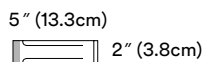

### 1115 Tube Organizer

Overall Size	Drapes/Box	Boxes/Case
5" x 2" (13.3cm x 3.8cm)	100	4

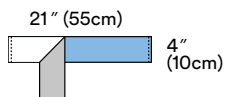

### 9099 Operation Tape

Overall Size	Drapes/Box	Boxes/Case
4" x 21" (10cm x 55cm)	250	2
<b>9099NS</b> (non-sterile) <i>Custom Packs Only</i>	1050 ea/cs	

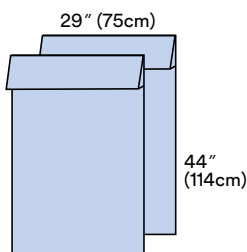

### 9040 Leggings (2)

Overall Size	Drapes/Box	Boxes/Case
29" x 44" (75cm x 114cm)	10	4
<b>9040NS</b> (non-sterile) <i>Custom Packs Only</i>	116 ea/cs	

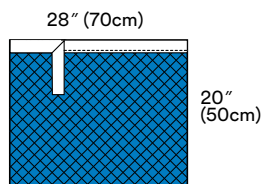

### 9095 Absorbent Pad

Overall Size	Drapes/Box	Boxes/Case
28" x 20" (70cm x 50cm)	50	4

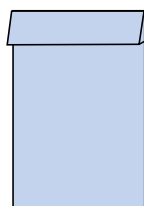

### Extremity Covers

	Overall Size	Drapes/Box	Boxes/Case
<b>9043</b>	15" x 23" (38cm x 60cm)	50	4
<b>9044</b>	15" x 39" (38cm x 100cm)	35	4
<b>9041NS</b> (non-sterile) <i>Custom Packs Only</i>		380 ea/cs	
<b>9042NS</b> (non-sterile) <i>Custom Packs Only</i>		250 ea/cs	



Absorbent Material



Absorbent Prevention Fabric



Standard Blue Fabric (fluid-repellent)



Clear plastic film



3M™ Ioban™ 2 Antimicrobial Incise Film



3M™ Steri-Drape™ 2 Incise Film



Adhesive area

# 3M™ Steri-Drape™

## FLUID COLLECTION POUCHES

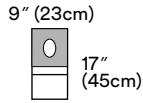

### 1072 Aperture Pouch Drape

Overall Size	Packs/Box	Boxes/Case
9" x 17" (23cm x 45cm)	10	4
<ul style="list-style-type: none"> <li>• Adhesive area: 9" x 10" (23cm x 25cm)</li> <li>• Oval aperture: 3.5" x 4.25" (9cm x 11cm)</li> <li>• Fluid collection pouch</li> </ul>		
<b>1072NS</b> (non-sterile) <i>Custom Packs Only</i>	200 ea/cs	

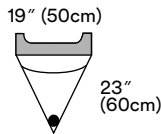

### 1016 Irrigation Pouch

Overall Size	Drapes/Box	Boxes/Case
19" x 23" (50cm x 60cm)	10	4
<ul style="list-style-type: none"> <li>• Adhesive strip</li> <li>• 1 – Exit port</li> <li>• Screen</li> </ul>		
<b>1016NS</b> (non-sterile) <i>Custom Packs Only</i>	200 ea/cs	

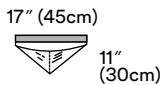

### 1027 Irrigation Pouch

Overall Size	Drapes/Box	Boxes/Case
17" x 11" (45cm x 30cm)	10	
<ul style="list-style-type: none"> <li>• Adhesive area: 9" x 10" (23cm x 26cm)</li> </ul>		

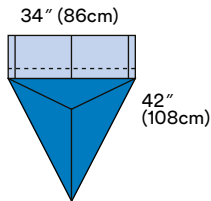

### 1084 Under Buttocks Drape with Pouch

Overall Size	Drapes/Box	Boxes/Case
34" x 42" (86cm x 108cm)	30	4
<ul style="list-style-type: none"> <li>• Cuff size: 10" (25cm)</li> <li>• Fluid collection pouch</li> </ul>		
<b>1084NS</b> (non-sterile) <i>Custom Packs Only</i>	140 ea/cs	

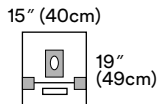

### 1024 Small Drape with Adhesive Aperture and Pouch

Overall Size	Drapes/Box	Boxes/Case
15" x 19" (40cm x 49cm)	10	4
<ul style="list-style-type: none"> <li>• Adhesive area: 4" x 5" (10cm x 12.5cm)</li> <li>• Oval aperture: 1" x 2" (3.5cm x 6.3cm)</li> <li>• 2 – Adhesive patches</li> <li>• Fluid collection pouch</li> </ul>		
<b>1024NS</b> (non-sterile) <i>Custom Packs Only</i>	200 ea/cs	

## KEY





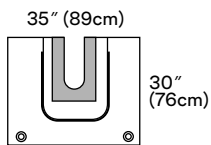

### 1067 U-pouch

Overall Size	Drapes/Box	Boxes/Case
35" x 30" (89cm x 76cm)	5	4

- Adhesive split: 6" x 15" (16cm x 40cm)
- Fluid collection pouch
- 2 – Exit ports

<b>1067NS</b> (non-sterile) <i>Custom Packs Only</i>	50 ea/cs	
--	----------	--

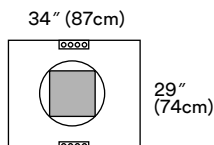

### 2057 Incise Pouch

Overall Size	Drapes/Box	Boxes/Case
34" x 29" (87cm x 74cm)	10	4

- Incise area: 12" x 12" (30cm x 30cm)
- 360-degree fluid collection pouch
- Tube and cord organizers

<b>2057NS</b> (non-sterile) <i>Custom Packs Only</i>	100 ea/cs	
--	-----------	--

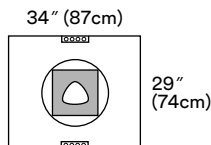

### 2058 Aperture Pouch Drape

Overall Size	Drapes/Box	Boxes/Case
34" x 29" (87cm x 74cm)	10	4

- Aperture incise area: 12" x 12" (30cm x 30cm)
- 360-degree fluid collection pouch
- Tube and cord organizers

<b>2058NS</b> (non-sterile) <i>Custom Packs Only</i>	100 ea/cs	
--	-----------	--

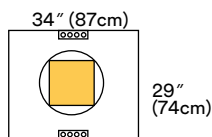

### 6657 Pouch with loban 2 Incise Film

Overall Size	Drapes/Box	Boxes/Case
34" x 29" (87cm x 74cm)	10	4

- loban 2 antimicrobial incise area: 11" x 11" (30cm x 30cm)
- 360-degree fluid collection pouch
- Tube and cord organizers

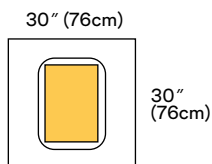

### 6658 Pouch with loban 2 Incise Film, Large

Overall Size	Drapes/Box	Boxes/Case
30" x 30" (76cm x 76cm)	5	4

- loban 2 antimicrobial incise area: 13" x 17" (33cm x 43cm)
- 360-degree fluid collection pouch

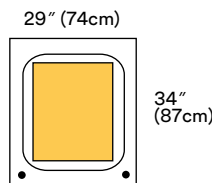

### 6659 Pouch with loban 2 Incise Film, Extra Large

Overall Size	Drapes/Box	Boxes/Case
29" x 34" (74cm x 87cm)	5	4

- loban 2 antimicrobial incise area: 16" x 20" (42cm x 52cm)
- 360-degree fluid collection pouch
- 2 – Exit ports



# 3M™ Steri-Drape™ EQUIPMENT DRAPES

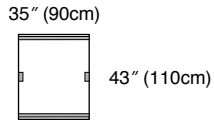

## 1012 Fluoroscope Drape

Overall Size	Drapes/Box	Boxes/Case
35" x 43" (90cm x 110cm)	10	4

- Adhesive strips for gathering excess materials

<b>1012NS</b> (non-sterile) <i>Custom Packs Only</i>	200 ea/cs
--	-----------

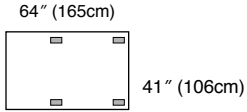

## 1013 C-arm Drape

Overall Size	Drapes/Box	Boxes/Case
41" x 64" (106cm x 165cm)	10	4

- Adhesive strips for gathering excess materials

<b>1013NS</b> (non-sterile) <i>Custom Packs Only</i>	200 ea/cs
--	-----------

### KEY

  
Absorbent  
Prevention Fabric

  
Standard Blue Fabric  
(fluid-repellent)

  
Clear plastic film

  
3M™ Ioban™ 2  
Antimicrobial  
Incise Film

  
3M™ Steri-Drape™ 2  
Incise Film

  
Adhesive area

## For more information

For more information about 3M surgical drapes or other 3M Health Care products:

- Contact your local 3M representative
- Call the 3M Health Care Customer Helpline: **1-800-228-3957**
- Visit the 3M Health Care products Web site: **[www.3M.com/Medical](http://www.3M.com/Medical)**



**Infection Prevention Division**  
**3M Health Care**  
3M Center, Building 275-4E-01  
St. Paul, MN 55144-1000  
U.S.A.  
800-228-3957  
[3m.com/medical](http://3m.com/medical)

3M, Coban, Ioban, and Steri-Drape  
are trademarks of 3M Company.  
Minimum 10% Post-Consumer Fiber  
Printed in U.S.A.  
Revised 2/18  
© 3M 2002, 2003, 2005, 2006, 2017, 2018  
All Rights Reserved.  
70-2009-1582-8