

Quick Start Guide

seca mVSA 535

- Sicherheitshinweise • Safety precautions
- Consignes de sécurité • Avisos de seguridad

1.

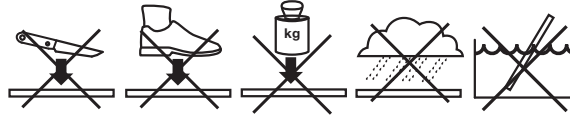

2.

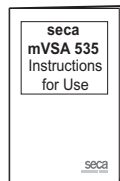

PDF: www.seca.com

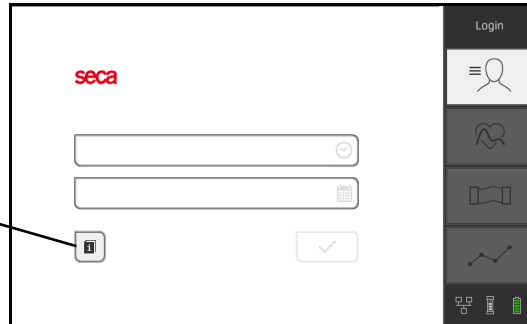

- Lieferumfang (Zubehör variantenabhängig) • Scope of delivery (accessories depend on version)
- Éléments livrés (accessoires selon le modèle) • Volumen de suministro (dependiendo de la variante del accesorio)

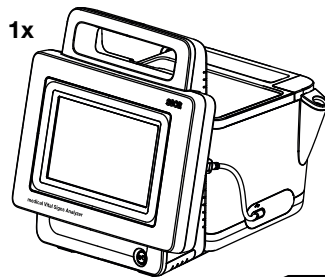

1x

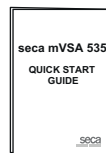

1x

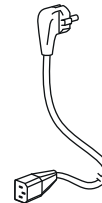

1x



Rx ONLY Warning: Federal (U.S.A.) law restricts this device to sale by or on the order of a licensed health care practitioner

- Blutdruckmanschette anschließen (variantenabhängig) • Connecting the blood pressure cuff (depending on version)
- Raccorder le brassard de tensiometre (selon le modèle)
- Conectar el manguito de presión arterial (dependiendo de la variante)

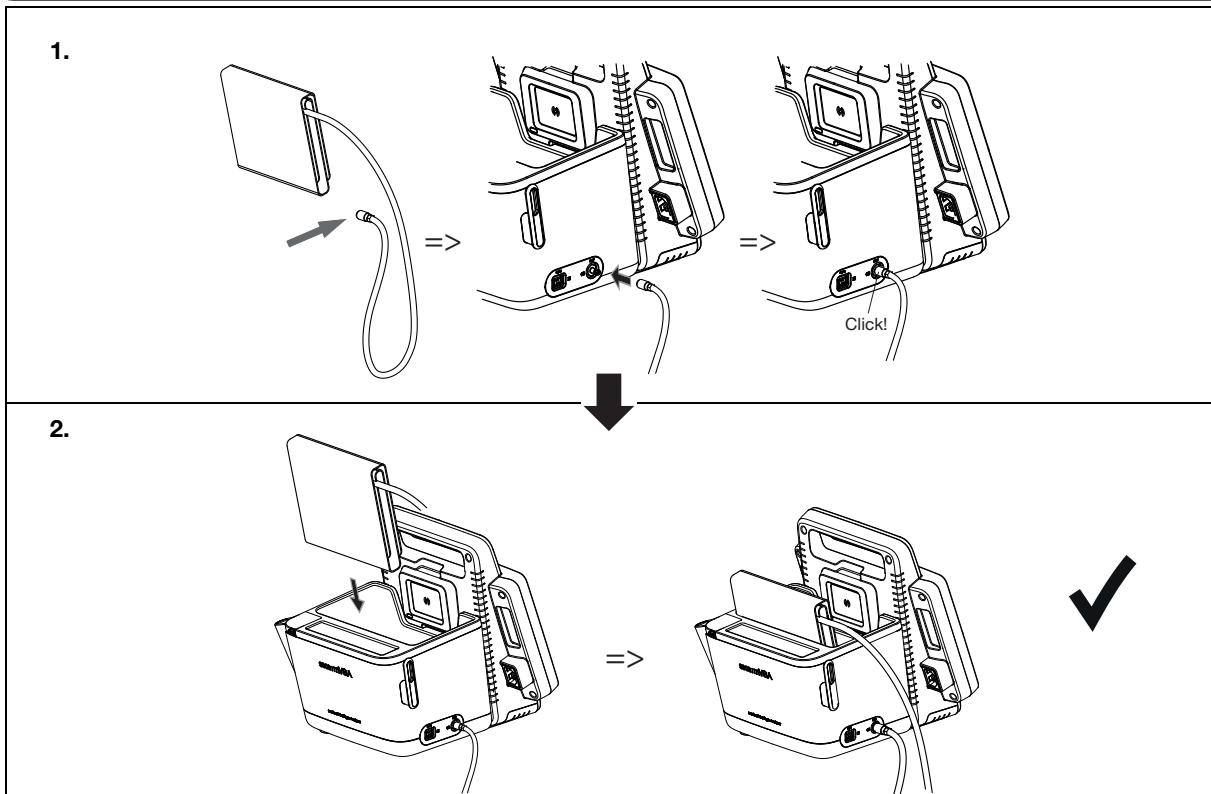

- Temperatursonde anschließen (variantenabhängig) • Connecting the temperature probe (depending on version)
- Raccorder la sonde de température (selon le modèle) • Conectar la sonda de temperatura (dependiendo de la variante)

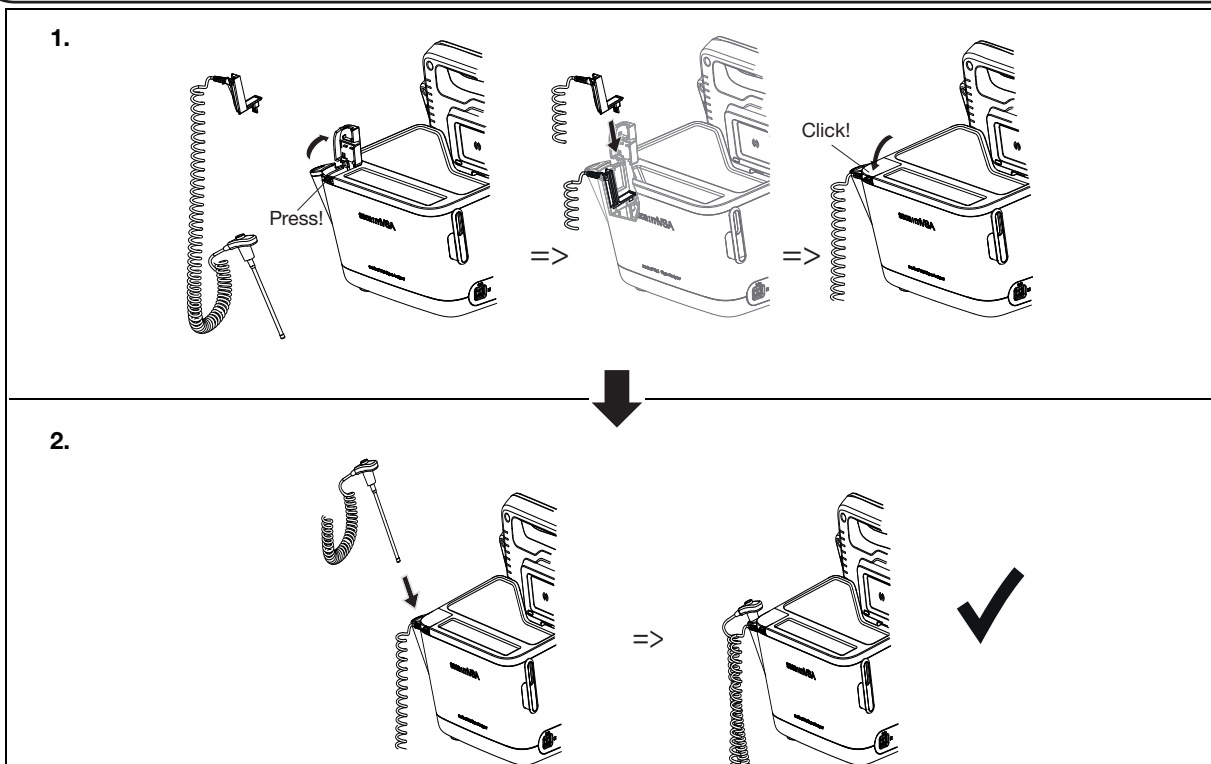

- SpO₂-Sensor anschließen (variantenabhängig) • Connecting the SpO₂ sensor (depending on version)
- Raccorder le capteur SpO₂ (selon le modèle) • Conectar el sensor de SpO₂ (dependiendo de la variante)

Masimo SET[®]:

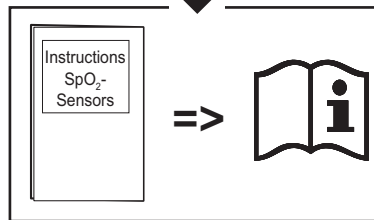
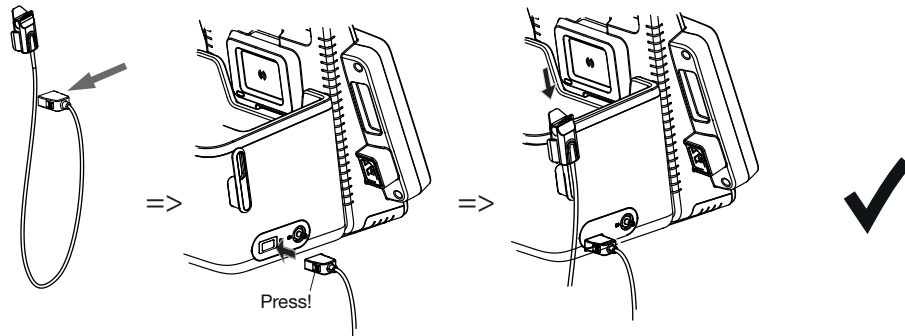

- Akkus laden • Charging Batteries
- Charger les piles • Cargar las baterías

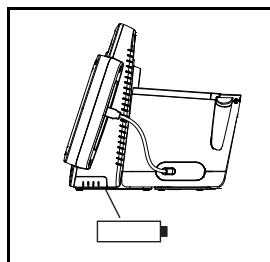
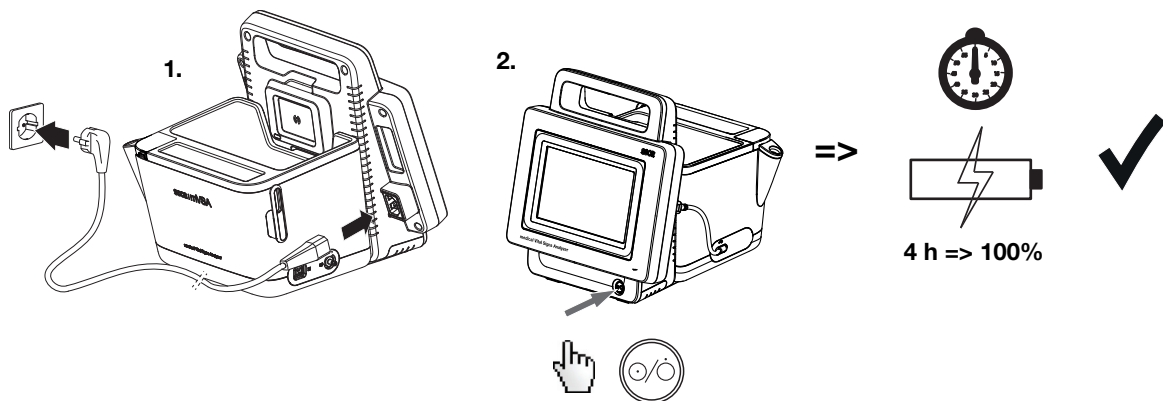

• Erster Systemstart: Datum/Uhrzeit einstellen • Initial system start: set Date/Time
• Démarrage initial du système : régler la date/l'heure • Primer inicio del sistema: ajustar fecha/hora

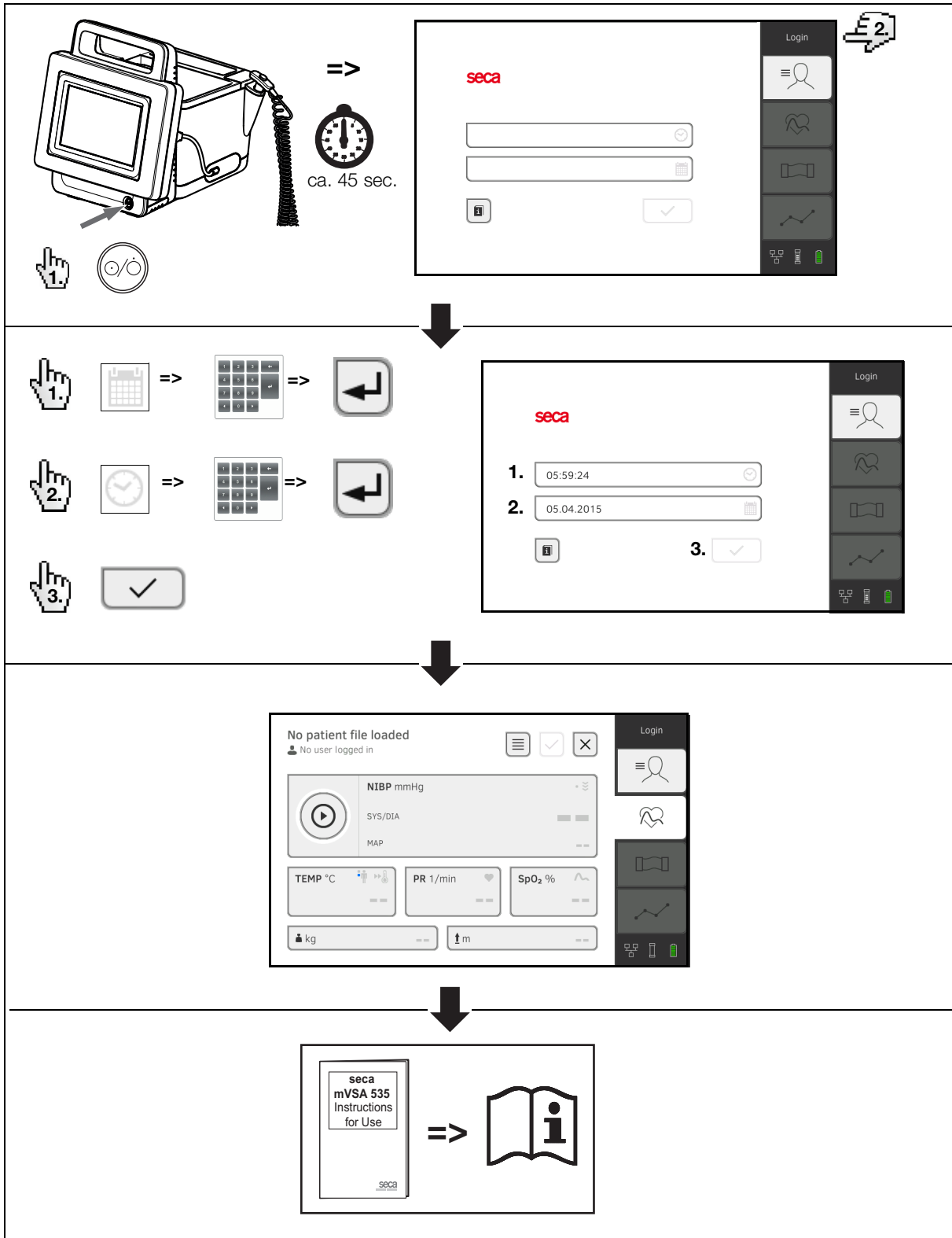

• Login • Login •
• Login • Iniciar sesión

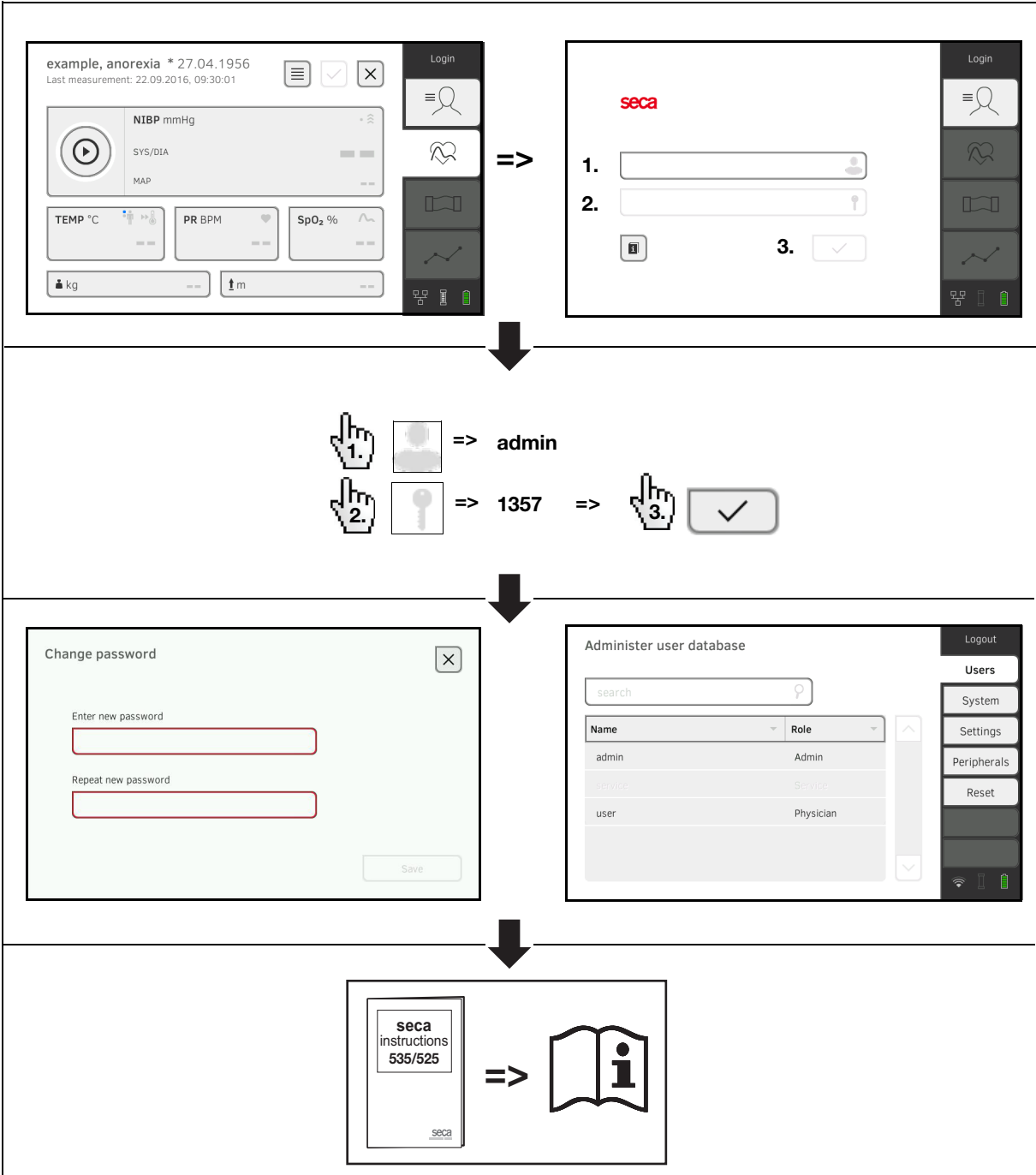

• **Gebrauchsanweisung ansehen** • **View instructions for use**
• **Accéder au mode d'emploi** • **Consultar las instrucciones de uso**

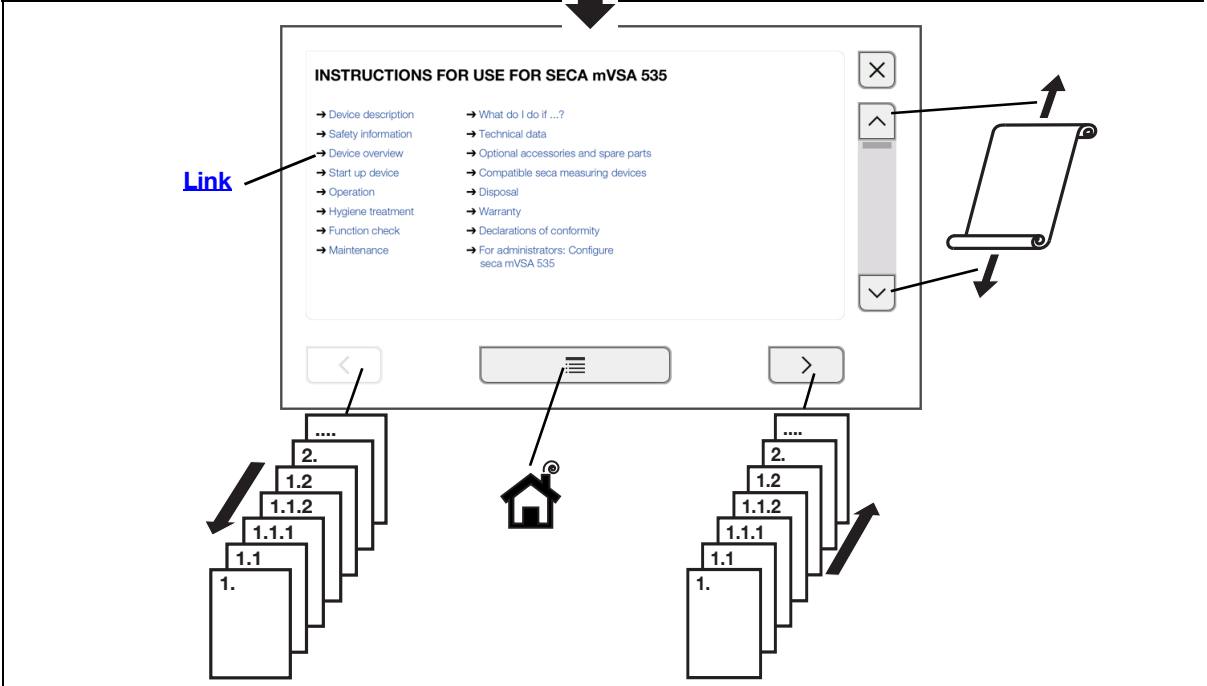
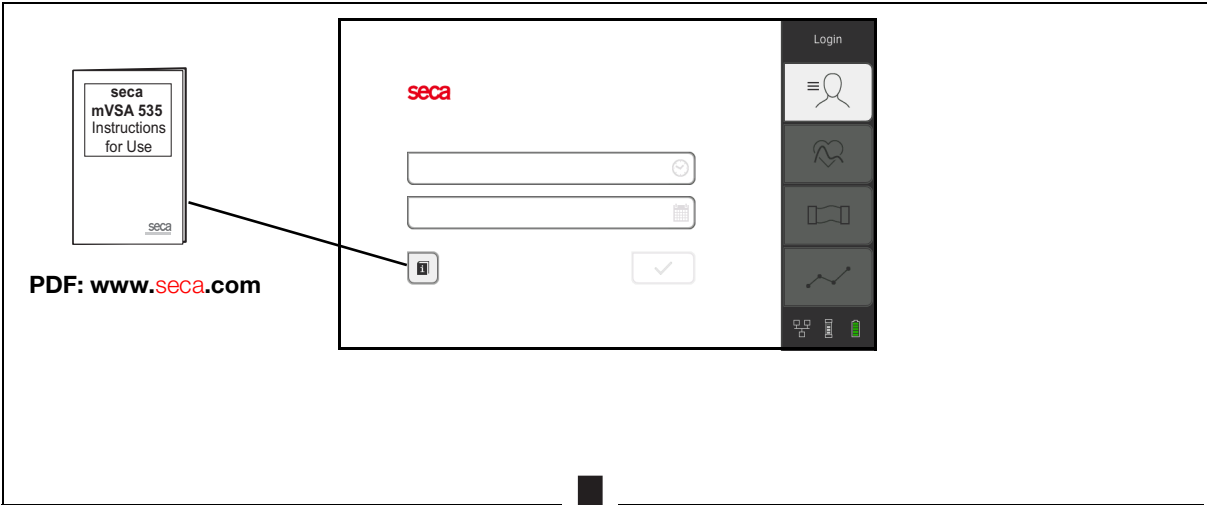

This device uses software known as „free“ or „open source“ software (FOSS). For details go to www.seca.com/opensource.

Medical Measuring Systems and Scales since 1840

seca gmbh & co. kg
Hammer Steindamm 3-25
22089 Hamburg · Germany
T +49 40 20 00 00 0
F +49 40 20 00 00 50
E info@seca.com

seca operates worldwide with headquarters
in Germany and branches in:

seca france
seca united kingdom
seca north america
seca schweiz
seca zhong guo
seca nihon
seca mexico
seca austria
seca polska
seca middle east
seca suomi
seca américa latina
seca asia pacific
seca danmark
seca benelux
seca lietuva

and with exclusive partners in
more than 110 countries.
All contact data at [seca.com](https://www.seca.com)