

EXPERIENCE EXCEPTIONAL PERFORMANCE

FROM FIRST TO FINAL STITCH



SharpPoint™ PLUS Surgical Suture Catalog

- Exceptional Needle Performance
- Thoughtfully Crafted Needle Tip
- Unique Needle Body Construction

WELCOME

For the last 40 years, Surgical Specialties Corporation has been trusted for quality, and we strive to continue to surpass the expectations of surgical professionals worldwide.

SharpPoint™ Surgical Sutures are precision engineered for consistent needle strength and durability. The portfolio features a number of specialty sutures designed to meet the exacting needs of plastic, dermatologic, micro, and ophthalmic surgeons.

- SharpPoint™ PLUS Surgical Sutures feature a premium needle and are hand assembled to rigorous quality standards guaranteeing a high-level of performance pass after pass.
- SharpPoint™ Microsutures are precisely engineered for microsurgery with an innovative tip geometry that provides enhanced stability and control.
- SharpPoint™ Ophthalmic Sutures offer dependable high-performance sutures designed for the most delicate ophthalmic procedures.

SharpPoint™ Surgical Sutures are offered in a variety of absorbable and non-absorbable materials and are attached to needles with superior sharpness, penetration, and strength characteristics.

Table Of Contents

Introduction

How to Use Our Catalog	1
Materials Chart	2
A Guide To Surgical Sutures.....	3
Needle Anatomy and Terminology	4
Needle Shapes And General Uses.....	5
Needle Points and Cutting Edges	5
Needle Charts	6

Absorbable Sutures

Plain Gut.....	7
Chromic Gut	8
PolySyn FA™ (Polyglycolic Acid).....	10
Monoderm™ (glycolide and e-caprolactone).....	11
PolySyn™ (Polyglycolic Acid)	13

Non-Absorbable Sutures

Silk	17
Nylon.....	19
Polypropylene.....	21
Polyviolene™ (polyester) - Uncoated.....	23

Product Index	29
---------------------	----

Introduction

How to Use Our Catalog

The pages in this catalog show the following information for each product code. Some products feature an expanded chart with detailed measurements (not shown in this sample) to ensure proper needle selection.

Needle Description - Contains an illustration of the needle. The comparable Ethicon™ needle code is black, and the comparable Syneture™ needle code is green. This section also lists the needle length (decimal 2 places included if not equal to zero) and shape.

Needle Geometry - Type of needle with tip geometry

Material - Color and style of suture

Length - Length in inches/centimeters

Reverse Cutting 

Size Grid - Indicates the U.S.P. size for each product code listed.

Needle	Material	Length	Size		
			6-0	5-0	4-0
DS12 12mm 3/8 Circle  C-2 C-1	Black Braided	18"/45cm	D1639N 1639G S1172	D0374N • S1173	D736N 736G S1174

• • indicates that other manufacturers do not have a comparable product code or needle.
 N=box of 12; D=box of 36; S=SmallStitch™ suture lengths of 8"-10"

— Sharpoint™ PLUS product code

— Ethicon™ comparable product code





— Syneture™ comparable product code

Materials Chart





Sharpoint™ PLUS	Ethicon™	Syneture™	Material
Plain Gut	Surgical Gut	Plain Gut	Natural Absorbable Gut
Chromic Gut	Surgical Gut	Chromic Gut	Natural Absorbable Gut
PolySyn FA™	Vicryl Rapide™	Velosorb™ Fast	Synthetic Absorbable, Braided, Coated Polyglycolic Acid
Monoderm™	Monocryl™	Caprosyn™/Biosyn™	Synthetic Absorbable, Monofilament Glycolide and E-caprolactone
PolySyn™	Vicryl™	Polysorb™/Dexon™	Synthetic Absorbable, Braided, Coated Polyglycolic Acid
Silk	Permahand Silk™	SofSilk™	Non-Absorbable, Braided, Coated Silk
Nylon	Ethilon™	Monosof™/Dermalon™	Non-Absorbable, Monofilament Nylon
Polypropylene	Prolene™	Surgipro™ II	Non-Absorbable, Monofilament Polypropylene
Uncoated Polyviolene™	Mersilene™	Surgidac™	Non-Absorbable, Braided, Uncoated Polyester

A Guide To Surgical Sutures

Absorbable

Material	Material Description	BSR Profile	Mass Absorption
Gut  • Surgical Gut Suture - Plain/Chromic * Plain Gut/Chromic Gut	Twisted <ul style="list-style-type: none"> Plain & Chromic Packaged Dry or in Wetting Solution Common uses: General Closure, OB/Gyn, Urology, Bowel Anastomosis	In vivo strength retention: Varies	Varies depending upon type of suture (plain vs. chromic) and site of placement
PolySyn FA™ (glycolic Acid)  • VICRYL RAPIDE™ * Velosorb™ Fast	Braided <ul style="list-style-type: none"> Undyed (clear) Coated Common uses: General Closure, OB/Gyn, Urology	In vivo strength retention: 48% at 7 days 0% at 14 days	Essentially complete between 49 and 63 days
Monoderm™ (glycolic Acid and ε-caprolactone)  • MONOCRYL™ * Caprosyn™/Biosyn™	Monofilament <ul style="list-style-type: none"> Undyed (clear) Dyed (violet) Common uses: Skin Closure, OB/Gyn, Urology, Gastrointestinal	In vivo strength retention: 42% to 76% at 7 days 36% to 52% at 14 days	Essentially complete by 90 days
PolySyn™ (glycolic Acid)  • VICRYL™ * Polysorb™/Dexon™	Braided <ul style="list-style-type: none"> Undyed (clear) Dyed (violet) Monofilament <ul style="list-style-type: none"> Undyed (clear) Dyed (violet) Coated & Uncoated Common uses: Skin Closure, OB/Gyn, Urology, Gastrointestinal	In vivo strength retention: 50% at 14 days 20% at 21 days	Essentially complete between 50 and 90 days

Non-Absorbable

Material	Material Description	Qualities
Silk  • PERMA-HAND™ Silk * SofSilk™	Braided <ul style="list-style-type: none"> Undyed (white) Dyed (black) Coated Common uses: General & Skin Closure, Gastrointestinal, Cardiovascular Surgery, Plastic Surgery, Ophthalmology	<ul style="list-style-type: none"> Excellent handling and tying characteristics
Nylon  • ETHILON™ * Monosof™/Dermalon™	Monofilament <ul style="list-style-type: none"> Undyed (clear) Dyed (blue) (black) Packaged dry or in wetting solution Common uses: General & Skin Closure, Plastic Surgery, Ophthalmology, Microsurgery, Cardiovascular Surgery, Gastrointestinal	<ul style="list-style-type: none"> Passes easily through tissue
Polypropylene  • PROLENE™ * Surgipro™/Surgipro™ II	Monofilament <ul style="list-style-type: none"> Undyed (clear) Dyed (blue) Common uses: General & Skin Closure, Neurosurgery, Plastic Surgery, Ophthalmology, Microsurgery, Cardiovascular Surgery	<ul style="list-style-type: none"> Inert Easy to handle Passes easily through tissue
Polyviolene™ (Uncoated) (poly (ethylene-terephthate))  • MERSILENE™ * Surgidac™	Braided <ul style="list-style-type: none"> Undyed (white) Dyed (green) Uncoated Common uses: General & Skin Closure, Plastic Surgery, Ophthalmology, Cardiovascular Surgery, Neurological Procedures	<ul style="list-style-type: none"> Smooth Easy to handle Good knot security

• Comparable Ethicon™ Material * Comparable Synture™ Material

Needle Anatomy And Terminology

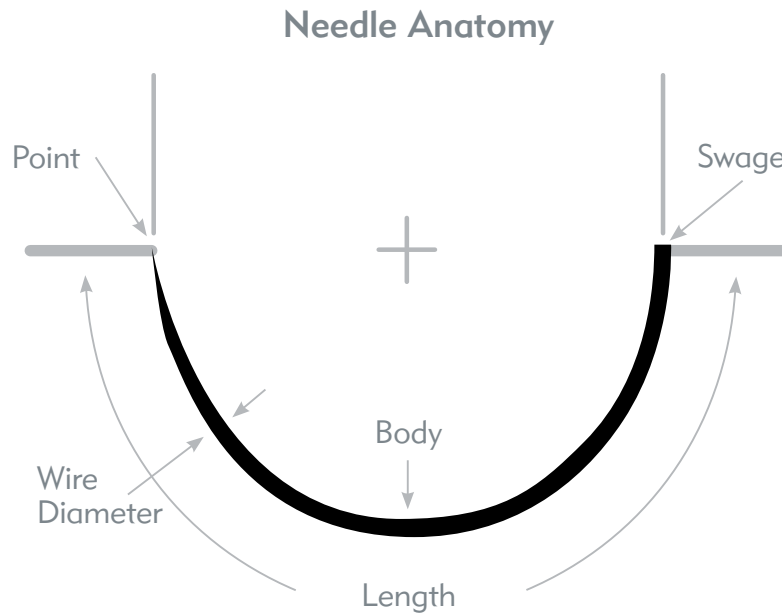

Needle Terminology

Length: Distance measured along the circumference of the needle, from the point to the swage. It is depicted on the packaging.

Shape: Different surgeries or surgical techniques demand different needle shapes.

Point: The sharpened part of the needle that first penetrates the tissue. The point consists of the area from the sharpened tip of the needle to the widest cross section of the needle body. The point determines ease of penetration and the initial size and shape of the hole.

Swage: Connection point of the suture and the needle. Micro teeth grip the suture material and prevent it from slipping out.

Wire Diameter: Gauge or thickness of the wire originally used to form the needle body.

Body: The part between the point and the swage of the needle.

Included Angle (Curvature): The fraction of the circle included in the curve of the needle. This is depicted on the packaging.

Needle Shapes And General Uses

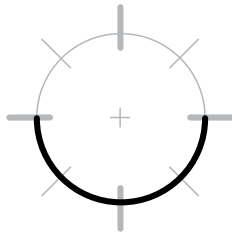



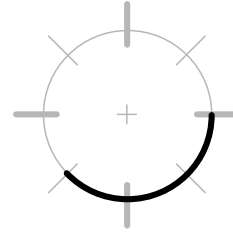

1/2 Circle: Skin Closure, GI, Cardiovascular, Ophthalmic



3/8 Circle: Skin Closure, Ophthalmic

Needle Points And Cutting Edges

Needle Type	Point Geometry	Description	Commonly Used For
Precision Conventional Cutting		Triangular point with cutting edge on the inner curvature and precision-honed for added sharpness	General skin closure, subcutaneous tissue, sometimes for ophthalmic surgery, plastic or reconstructive surgery
Precision Reverse Cutting		Triangular point with cutting edge on the outer curvature and precision-honed for added sharpness	Primarily used in plastic surgery for delicate procedures and where a good cosmetic result is desired
Taper Point		Round shaft, straight or curved, taper point with no cutting edge	Soft tissue closure such as fascia, vascular, gastrointestinal, and most soft tissue below the skin
Diamond Point		Modified taper cutting needle	Penetration of tougher tissues like the dermis

Needle Chart

Diamond Point Needles



Surgical Specialties	Ethicon™	Syneture™
3/8 Circle		
DE7	G-6	HE-6



Taper Point Needles



Surgical Specialties	Ethicon™	Syneture™
1/2 Circle		

HR13	TF	CV-22
HR18	RB-1	CV-23
HR22	SH-1	CV-25
HR26	SH	V-20
HR26	CT-2	GS-22
HR30	•	V-30
HR36	MH	V-26
HR36	CT-1	GS-21
HR40	CT	GS-24X

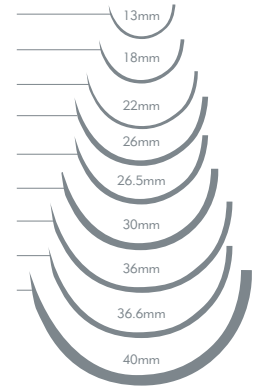

Precision Conventional Cutting Needles



Surgical Specialties	Ethicon™	Syneture™
3/8 Circle		
DSCM11	PC-1	P-13
DSCM13	PC-1	P-13
DSCM16	PC-3	PC-11
DSCM19	PC-5	P-12



Precision Reverse Cutting Needles



Surgical Specialties	Ethicon™	Syneture™
3/8 Circle		
DSM11	P-1	P-10
DSM12	C-2	C-1
DSM13	P-3	P-13
DSM16	PS-3	P-11
DSM19	PS-2	P-12
DSM19	PS-2	P-12
DSM24	PS-1	P-14
DSM26	FS	C-15
DSM30	FSL	C-16
DSM36	FSLX	C-17
DSM40	FSLX	C-17

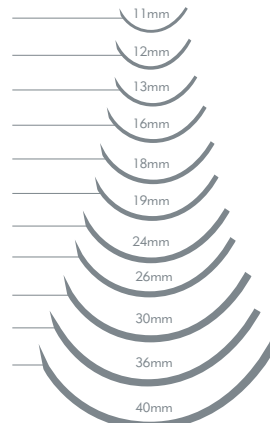



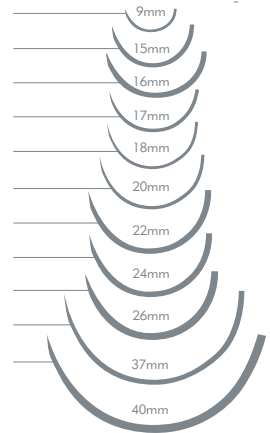





1/2 Circle		
HSM9	P-2	P-21
HSM15	M-1	C-21
HSM16	•	•
HSM17	J-1	C-22
HSM18	•	•
HSM20	J-1	C-22
HSM22	X-1	C-23
HSM24	X-1	C-23
HSM26	CP-2	GS-10
HSM36	CP-1	GS-11
HSM40	CP	GS-12



Plain Gut

Precision Reverse Cutting ▾

Needle	Material	Length	Size						
			6-0	5-0	4-0	3-0	2-0	0	
DSM11 11mm 3/8 Circle  P-1 P-10	Plain Gut	12"/30cm	B2698N • •						
		18"/45cm	B660N/ B774N 774G SG1645						
DSM11 11mm 3/8 Circle  P-1 P-10	Plain Gut	18"/45cm	B770N 770G SG1645						
DSM12 12mm 3/8 Circle  P-3 P-13	Plain Gut	10"/45cm		B521NS • •					
		18"/45cm		B686N 686G SG5686					
DSM19 19mm 3/8 Circle  PS-2 P-12	Plain Gut	18"/45cm		B0500N • SG751	B2463N • SG752	B592N • SG5630G			
		27"/70cm		B820N H820G SG820G	B821N H821H SG821G	B822N H822H SG822G			
DSM24 24mm 3/8 Circle  PS-1 P-14	Plain Gut	27"/70cm				B810N H810H SG810	B823N H823H SG823		
HSM15 15mm 1/2 Circle  M-1 C-21	Plain Gut	18"/45cm			B537N • •				
HSM22 22mm 1/2 Circle  X-1 C-23	Plain Gut	18"/45cm				B612N 612G SG612G			
HSM24 24mm 1/2 Circle  X-1 C-23	Plain Gut	18"/45cm			B0599N • SG1633G				
HSM26 26mm 1/2 Circle  CP-2 GS-10	Plain Gut	18"/45cm				B0593N • SG612G			









Product numbers are color coded respectively as SharpPoint™ PLUS (dark blue), comparable Ethicon™ (black), and comparable Syneture™ (green).

• indicates that other manufacturers do not have a comparable product code or needle.

N=box of 12; D=box of 36; S=SmallStitch™ suture lengths of 8"-10".

Chromic Gut

Precision Reverse Cutting ▾

Needle	Material	Length	Size						
			6-0	5-0	4-0	3-0	2-0	0	
DSM11 11mm 3/8 Circle  P-1 P-10	Chromic Gut	12"/30cm	C796N 796G G1780						
DSM12 12mm 3/8 Circle  P-3 P-13	Chromic Gut	18"/45cm		C0563N 687G SG197					
DSM13 13mm 3/8 Circle  P-3 P-13	Chromic Gut	18"/45cm		C687N 687G SG5687G					
DSM13 13mm 3/8 Circle  P-3 DX-13	Chromic Gut	18"/45cm		C792N 792G •					
DSM16 16mm 3/8 Circle  PS-3 P-11	Chromic Gut	18"/45cm		C1636N 1636G •					
DSM19 19mm 3/8 Circle  PS-2 P-12	Chromic Gut	18"/45cm		C1637N/ C558N 1637G SG5637G/ SG675		C525N • SG676			
		27"/70cm		C634N 634G •	C635N 635H SG635G	C1638N/ C636N 1638H/ 636H SG5163G/ SG636G			
		30"/75cm		C0935N • SG634G					
DSM24 24mm 3/8 Circle  PS-1 P-14	Chromic Gut	27"/70cm				C100N • •	C637N 637H SG637G		
DSM26 26mm 3/8 Circle  FS C-15	Chromic Gut	27"/70cm						C0562N • •	

Product numbers are color coded respectively as SharpPoint™ PLUS (dark blue), comparable Ethicon™ (black), and comparable Syneture™ (green).

• indicates that other manufacturers do not have a comparable product code or needle.

N=box of 12; D=box of 36; S=SmallStitch™ suture lengths of 8"-10".

Chromic Gut

Precision Reverse Cutting (cont'd) ▾

Needle	Material	Length	Size						
			6-0	5-0	4-0	3-0	2-0	0	
HSM15 15mm 1/2 Circle  M-1 C-21	Chromic Gut	18"/45cm		C1642N 1642G •					
HSM20 20mm 1/2 Circle  J-1 C-22	Chromic Gut	18"/45cm			C1643N 1643G •				





Product numbers are color coded respectively as SharpPoint™ PLUS (dark blue), comparable Ethicon™ (black), and comparable Syneture™ (green).

• indicates that other manufacturers do not have a comparable product code or needle.

N=box of 12; D=box of 36; S=SmallStitch™ suture lengths of 8"-10".

PolySyn FA™ / Polyglycolic Acid

Precision Reverse Cutting ▾

Needle	Material	Length	Size					
			6-0	5-0	4-0	3-0	2-0	0
DSM11 11mm 3/8 Circle  P-1 P-10	Undyed Braided	18"/45cm		M490N VCP490G SL1689G				
DSM19 19mm 3/8 Circle  PS-2 P-12	Undyed Braided	18"/45cm			M496N VR496	M497N VR497		
		27"/70cm			M426N VR426	M0423N		
DSM24 24mm 3/8 Circle  PS-1 P-14	Undyed Braided	27"/70cm				M442N VC442H		
HSM24 24mm 1/2 Circle  X-1 C-23	Undyed Braided	18"/45cm				M456N CL53MG		

Taper Point ⊙



Needle	Material	Length	Size					
			6-0	5-0	4-0	3-0	2-0	0
HR17 17mm 1/2 Circle  RB-1 CV-23	Undyed Braided	27"/70cm			M214N VR214			

Product numbers are color coded respectively as SharpPoint™ PLUS (dark blue), comparable Ethicon™ (black), and comparable Syneture™ (green).



• indicates that other manufacturers do not have a comparable product code or needle.

N=box of 12; D=box of 36; S=SmallStitch™ suture lengths of 8"-10".

Precision Conventional Cutting

Needle	Material	Length	Size					
			6-0	5-0	4-0	3-0	2-0	0
DSCM13 13mm 3/8 Circle  PC-1 P-13	Undyed Monofilament	18"/45cm	Y833N • •					
		10"/25cm		Y844NS Y844G SC5626G	Y845NS Y845G SC5686G			
DSCM16 16mm 3/8 Circle  PC-3 PC-11	Undyed Monofilament	18"/45cm		Y844N Y844G SC5626G	Y845N Y845G SC5686G			
		10"/25cm			Y823NS • •			
DSCM19 19mm 3/8 Circle  PC-5 P-12	Undyed Monofilament	18"/45cm		Y822N Y822G SC5616G	Y823N Y823G SC5617G			
		10"/25cm						

Precision Reverse Cutting

Needle	Material	Length	Size					
			6-0	5-0	4-0	3-0	2-0	0
DSM11 11mm 3/8 Circle  P-1 P-10	Undyed Monofilament	10"/25cm		Y490NS • •				
		18"/45cm	Y489N Y489G SC3625G	Y490N Y490G SC3626G				
DSM13 13mm 3/8 Circle  P-3 P-13	Undyed Monofilament	10"/25cm		Y493NS • •	Y494NS • •			
		18"/45cm	Y492N Y492G SC5688G	Y493N Y493G SC5689G/ SC5687	Y494N Y494G SC5690G			
	Violet Monofilament	18"/45cm		Y463N Y463G SC5587G	Y464N Y464G SC5590G			
DSM19 19mm 3/8 Circle  PS-2 P-12	Undyed Monofilament	10"/25cm		Y495NS • •	Y426NS • •	Y427NS • •		
		18"/45cm		Y495N Y495G SC5616G	Y496N Y496G SC5635G	Y497N Y497G SC5618G		
		27"/70cm			Y426N Y426G SC5637/ SC5637G	Y427N Y427H •		
	Violet Monofilament	18"/45cm			Y513N Y513G SC5627G			

Product numbers are color coded respectively as SharpPoint™ PLUS (dark blue), comparable Ethicon™ (black), and comparable Syneture™ (green).

• indicates that other manufacturers do not have a comparable product code or needle.

N=box of 12; D=box of 36; S=SmallStitch™ suture lengths of 8"-10".

Precision Reverse Cutting (cont'd) ▾

Needle	Material	Length	Size					
			6-0	5-0	4-0	3-0	2-0	0
DSM24 24mm 3/8 Circle  PS-1 P-14	Undyed Monofilament	18"/45cm			Y682N Y682H SC5679	Y936N Y936H SC5780G		
HSM9 9mm 1/2 Circle  P-2 P-21	Undyed Monofilament	18"/45cm		Y503N • •	Y504N • •			

Taper Point ⊙

Needle	Material	Length	Size					
			6-0	5-0	4-0	3-0	2-0	0
HR13 13mm 1/2 Circle  TF CV-22	Undyed Monofilament	27"/70cm	Y432N Y432H UM886	Y433N Y433H SM432	Y434N Y434H SM431			

Product numbers are color coded respectively as SharpPoint™ PLUS (dark blue), comparable Ethicon™ (black), and comparable Syneture™ (green).
 • indicates that other manufacturers do not have a comparable product code or needle.
 N=box of 12; D=box of 36; S=SmallStitch™ suture lengths of 8"-10".

PolySyn™ / Polyglycolic Acid

Diamond Point

Needle	Material	Length	Size					
			6-0	5-0	4-0	3-0	2-0	
DE7 8.13mm 3/8 Circle  G-6 HE-6	Violet Braided	12"/30cm	G551N J551G L1551K					

Precision Conventional Cutting

Needle	Material	Length	Size					
			6-0	5-0	4-0	3-0	2-0	
DSCM16 16mm 3/8 Circle  PC-3 PC-11	Undyed Braided	18"/45cm			G835N J845G SL1657			

Precision Reverse Cutting

Needle	Material	Length	Size					
			6-0	5-0	4-0	3-0	2-0	
DSM11 11mm 3/8 Circle  P-1 P-10	Undyed Braided	8"/20cm	G489NS • •					
		18"/45cm		G490N J490G SL1698G				
DSM13 13mm 3/8 Circle  P-3 P-13	Undyed Braided	10"/25cm		G493NS • •				
DSM16 16mm 3/8 Circle  PS-3 P-11	Undyed Braided	18"/45cm		G500N J500G SL5626G		G0508N • SL5621		





Product numbers are color coded respectively as Sharpoint™ PLUS (dark blue), comparable Ethicon™ (black), and comparable Syneture™ (green).

• • indicates that other manufacturers do not have a comparable product code or needle.

N=box of 12; D=box of 36; S=SmallStitch™ suture lengths of 8"-10".

PolySyn™/ Polyglycolic Acid

Precision Reverse Cutting (cont'd) ▾

Needle	Material	Length	Size				
			6-0	5-0	4-0	3-0	2-0
DSM19 19mm 3/8 Circle 	Undyed Braided	8"/20cm		G495NS • •	G496NS • •		
		18"/45cm		G495N J495G XL822/ SL5636G	G496N J496G XL823/ SL5627G	G497N J497G XL824/ SL5628G	
		27"/70cm		G421N J421H SL690G	G426N/ G422N/ G422D J426H/ J422H/ J441G SL5637/ SL691G/ SL692G	G427N/ G423N J427H/ J423H/ J442H SL5638/ SL822G/ SL693	
		30"/75cm			G691D • •		
	Violet Braided	18"/45cm		G391N J391H SL634	G392N J392H SL635G	G393N J393H SL822	
		27"/70cm			G0392N • •		
PS-2 P-12							
DSM24 24mm 3/8 Circle 	Undyed Braided	18"/45cm				G683N J683G SL5640G	
		27"/70cm			G441N • •	G442N • •	G443N/ G443D J443H SL823
	Violet Braided	27"/70cm			G451N • •		
PS-1 P-14							
HSM9 9mm 1/2 Circle 	Undyed Braided	18"/45cm		G503N J503G SL1644G			
P-2 P-21							
HSM16 16mm 1/2 Circle 	Undyed Braided	18"/45cm		G506N J506G SL5632G	G507N J507G SL5633G		
PS-4 P-12							

Product numbers are color coded respectively as SharpPoint™ PLUS (dark blue), comparable Ethicon™ (black), and comparable Syneture™ (green).

• • indicates that other manufacturers do not have a comparable product code or needle.

N=box of 12; D=box of 36; S=SmallStitch™ suture lengths of 8"-10".

PolySyn™ / Polyglycolic Acid



Precision Reverse Cutting (cont'd) ▽

Needle	Material	Length	Size					
			5-0	4-0	3-0	2-0	0	1
HSM40 40mm 1/2 Circle  CP GS-12	Violet Braided	27"/70cm						G480N J480H CL805
		36"/90cm						G486N J486H •

Precision Reverse Cutting ▽ / Taper Point ⊙

Needle	Material	Length	Size					
			6-0	5-0	4-0	3-0	2-0	0
HSM36/HR36 36mm / 36mm 1/2 Circle  CP-1 GS-11 CT-1 GS-21	Violet Braided	54"/135cm						G532N J532H •

Taper Point ⊙

Needle	Material	Length	Size					
			6-0	5-0	4-0	3-0	2-0	0
HR13 13mm 1/2 Circle  TF CV-22	Undyed Braided	27"/70cm		G433N • •				
	Violet Braided	18"/45cm	G981N • •					
HR18 17mm 1/2 Circle  RB-1 CV-23	Undyed Braided	27"/70cm			G714N J714D UL212			
HR22 22mm 1/2 Circle  SH-1 CV-24	Violet Braided	27"/70cm			G310N J310H GL181	G311N J311H GL182		





Product numbers are color coded respectively as SharpPoint™ PLUS (dark blue), comparable Ethicon™ (black), and comparable Syneture™ (green).

• indicates that other manufacturers do not have a comparable product code or needle.

N=box of 12; D=box of 36; S=SmallStitch™ suture lengths of 8"-10".

PolySyn™/ Polyglycolic Acid

Taper Point (cont'd)







Needle	Material	Length	Size				
			4-0	3-0	2-0	0	1
HR26 26mm 1/2 Circle  CT-2 GS-22	Undyed Braided	18"/45cm			G0417N • GL61MG		
	Undyed Braided	27"/70cm		G232N J232H CL829	G269N J269H CL830		
	Violet Braided	27"/70cm		G332N/ G316N J332H CL882	G333N J333H CL883		
HR30 30mm 1/2 Circle  • V-30	Violet Braided	30"/75cm		G0322N • •	G323N • •		
	HR36 36.6mm 1/2 Circle  CT-1 GS-21	Undyed Braided	18"/45cm			G839N J839D CL13MG	
27"/70cm						G260N J260H CL844	
36"/90cm					G945N J945H CL953		
Violet Braided		27"/70cm			G339N J339H CL930	G340N J340H CL812	G341N J341H CL813
		36"/90cm			G354N J345H •	G0518N • •	
HR40 40mm 1/2 Circle  CT GS-24	Violet Braided	27"/70cm			G352N J352H CL802		
		36"/90cm					G359N J359H •

Product numbers are color coded respectively as Sharpoint™ PLUS (dark blue), comparable Ethicon™ (black), and comparable Syneture™ (green).

• indicates that other manufacturers do not have a comparable product code or needle.

N=box of 12; D=box of 36; S=SmallStitch™ suture lengths of 8"-10".

Precision Reverse Cutting ▾

Needle	Material	Length	Size						
			6-0	5-0	4-0	3-0	2-0	0	
DSM11 11mm 3/8 Circle  P-1 P-10	Black Braided	18"/45cm	D639N 639G SS1639G						
DSM12 12mm 3/8 Circle  P-3 P-13	Black Braided	18"/45cm	D1639N 1639G S1172						
DSM16 16mm 3/8 Circle  PS-3 P-11	Black Braided	18"/45cm			D0239N • SS686	D0389N • •			
		30"/75cm			D0208N • •				
DSM19 19mm 3/8 Circle  PS-2 P-12	Black Braided	18"/45cm		D682N 682G SS682G	D683N/ D1677N 683G/ 1677G SS683G/ SS5677G	D1679N 1679H SS694/ SS5679			
		30"/75cm				D0768N • SS745			
DSM24 24mm 3/8 Circle  PS-1 P-14	Black Braided	18"/45cm			D629N 629G SS629	D684N 684G SS684G	D0238N 685G SS695		
		30"/75cm				D0775N • •			
DSM26 26mm 3/8 Circle  FS C-15	Black Braided	18"/45cm					D685N 685G SS685G		
		30"/75cm				D0212N • •			

Product numbers are color coded respectively as SharpPoint™ PLUS (dark blue), comparable Ethicon™ (black), and comparable Syneture™ (green).

• • indicates that other manufacturers do not have a comparable product code or needle.

N=box of 12; D=box of 36; S=SmallStitch™ suture lengths of 8"-10".

Precision Reverse Cutting (cont'd) ▾

Needle	Material	Length	Size					
			5-0	4-0	3-0	2-0	0	1
DSM30 30mm 3/8 Circle  FSL C-16	Black Braided	18"/45cm			D0765N • •		D678N 678G •	
		30"/75cm			D675N 675H SS675	D679N 679H SS679	D680N 680H SS680	
DSM36 36mm 3/8 Circle  FSLX C-17	Black Braided	30"/75cm				D0213N • SS648		D0423N • SS646
HSM15 15mm 1/2 Circle  M-1 C-21	Black Braided	18"/45cm	D779N • •	D777N • •	D778N • •			
HSM16 16mm 1/2 Circle  • •	Black Braided	18"/45cm			D2460N • •			
HSM17 17mm 1/2 Circle  J-1 C-22	Black Braided	18"/45cm		D734N 734G SS733				
HSM18 18mm 1/2 Circle  • •	Black Braided	18"/45cm			D0783N • •			
HSM22 22mm 1/2 Circle  • •	Black Braided	18"/45cm			D632N 632G SS732			
HSM26 26mm 1/2 Circle  CP-2 GS-10	Black Braided	18"/45cm			D782N • •			

Product numbers are color coded respectively as SharpPoint™ PLUS (dark blue), comparable Ethicon™ (black), and comparable Syneture™ (green).

• • indicates that other manufacturers do not have a comparable product code or needle.





N=box of 12; D=box of 36; S=SmallStitch™ suture lengths of 8"-10".

Nylon

Precision Conventional Cutting

Needle	Material	Length	Size					
			6-0	5-0	4-0	3-0	2-0	0
DSCM16 16mm 3/8 Circle  PC-3 PC-11	Black Monofilament	18"/45cm		A1865N 1865G SN3965	A1864N 1864G SN1964			
	Black Monofilament Pliable	18"/45cm		A1965N 1965G SN3965				

Precision Reverse Cutting

Needle	Material	Length	Size				
			7-0	6-0	5-0	4-0	3-0
DSM11 11mm 3/8 Circle  P-1 P-10	Black Monofilament	8"/20cm		A697NS • •			
		18"/45cm	A1696N 1696G SN3686	A697N 697G SN3697			
DSM12 12mm 3/8 Circle  C-2 C-1	Black Monofilament	9"/23cm		A2557NS • •	A2558NS • •		
		10"/23cm		A911NS • •	A913NS • •		
		10"/25cm				A931NS • •	
		18"/45cm		A667N 667G SN667G		A921N 1954G SN872	
DSM13 13mm 3/8 Circle  P-3 P-13	Clear Monofilament	18"/45cm				A691N 691G SN5691G	
DSM16 16mm 3/8 Circle  FS-3 C-12	Black Monofilament	18"/45cm			A0556N/ A1668N 1668G/ 1658G SN659G/ SN5668G		







Product numbers are color coded respectively as SharpPoint™ PLUS (dark blue), comparable Ethicon™ (black), and comparable Syneture™ (green).

• • indicates that other manufacturers do not have a comparable product code or needle.

N=box of 12; D=box of 36; S=SmallStitch™ suture lengths of 8"-10".

Nylon

Precision Reverse Cutting (cont'd) ▾

Needle	Material	Length	Size					
			5-0	4-0	3-0	2-0	0	1
DSM19 19mm 3/8 Circle 	Black Monofilament	8"/20cm	A1666NS • •	A1667NS • •				
		10"/25cm	A661NS • •	A662NS • •				
18"/45cm		A661N/ A5666D/ A1666N 661G/ 661H/ 1666G SN661G/ SN5666G	A662N/ A662D/ A1667N 662G/ 1667G SN662G/ SN5667G	A1669N 1669G SN5669G				
PS-2 P-12	Clear Monofilament	18"/45cm		A1611N 1611G SN5677	A2506N • SMM5044			
DSM24 24mm 3/8 Circle 	Black Monofilament	10"/25cm		A947NS 1629H SN658				
		18"/45cm		A1629N 1629H SN658	A663N/ A1663N 663G/ 1663G SN663G/ SN5633G			
		30"/75cm			A669N 669H SN669G			
DSM26 26mm 3/8 Circle 	Black Monofilament	18"/45cm				A664N 664G SN764G		
	Blue Monofilament	30"/75cm			A1328N • •	A8685N 8685H SP868G		
DSM30 30mm 3/8 Circle 	Clear Monofilament	27"/70cm		A1671N 1671H SN671				
DSM40 40mm 3/8 Circle 	Blue Monofilament	30"/75cm				A0616N • •		A0620N • •
HSM16 16mm 1/2 Circle 	Black Monofilament	18"/45cm		A1662N 1662G SN5662G				

Product numbers are color coded respectively as SharpPoint™ PLUS (dark blue), comparable Ethicon™ (black), and comparable Syneture™ (green).

• indicates that other manufacturers do not have a comparable product code or needle.





N=box of 12; D=box of 36; S=SmallStitch™ suture lengths of 8"-10".

Polypropylene

Precision Conventional Cutting

Needle	Material	Length	Size					
			6-0	5-0	4-0	3-0	2-0	0
DSCM11 11mm 3/8 Circle  PC-1 P-13	Blue Monofilament	8"/20cm		J1058NS • •				
DSCM16 16mm 3/8 Circle  PC-3 P-11	Blue Monofilament	18"/45cm		J8635N 8635G •				

Precision Reverse Cutting

Needle	Material	Length	Size				
			7-0	6-0	5-0	4-0	3-0
DSM11 11mm 3/8 Circle  P-1 P-10	Blue Monofilament	8"/20cm		J8697NS • •			
		18"/45cm	J8696N 8696G SP1696G	J8697N 697G SN3697	J8694N • •		
DSM12 12mm 3/8 Circle  C-2 C-1	Blue Monofilament	10"/25cm			J1013NS • •		
DSM13 13mm 3/8 Circle  P-3 P-13	Blue Monofilament	8"/20cm			J1078NS • •		
		18"/45cm		J8695N 8695G/ 8617G SP5695G/ SP1617	J8698N 8698G SP5698G		
DSM16 16mm 3/8 Circle  P-3 P-13	Blue Monofilament	18"/45cm			J8681N 8681G SP5681G		
DSM19 19mm 3/8 Circle  PS-2 P-12	Blue Monofilament	8"/20cm				J8682NS • •	
		18"/45cm		J8686N/ J661N/ J8661N 8686G/ 8661G SP5686G/ SP661G	J8682N/ J683N/ J8683D/ J8683N 8682G/ 8683G SP5682G/ SP683G	J8687N/ J8665N 8687G/ 8665G SP5687G/ SP665G	

Product numbers are color coded respectively as SharpPoint™ PLUS (dark blue), comparable Ethicon™ (black), and comparable Syneture™ (green).

• indicates that other manufacturers do not have a comparable product code or needle.

N=box of 12; D=box of 36; S=SmallStitch™ suture lengths of 8"-10".

Polypropylene

Precision Reverse Cutting (cont'd) ▾

Needle	Material	Length	Size				
			6-0	5-0	4-0	3-0	2-0
DSM24 24mm 3/8 Circle  PS-1 P-14	Blue Monofilament	18"/45cm			J8629N 8629H •	J8663N/ J8684N 8663G/ 8684G SP5663G/ SP684G	
DSM26 26mm 3/8 Circle  FS C-15	Blue Monofilament	18"/45cm				J1239N • SP684G	J8685N 8685G SP868G

Taper Point ⊙

Needle	Material	Length	Size							
			8-0	7-0	6-0	5-0	4-0	3-0	0	
HR36 36mm 1/2 Circle  MH V-26	Blue Monofilament	40"/100cm								J8424N 8424H •



Product numbers are color coded respectively as SharpPoint™ PLUS (dark blue), comparable Ethicon™ (black), and comparable Syneture™ (green).

• indicates that other manufacturers do not have a comparable product code or needle.

N=box of 12; D=box of 36; S=SmallStitch™ suture lengths of 8"-10".

Polyviolene™ / Polyester - Uncoated

Precision Reverse Cutting ▾

Needle	Material	Length	Size					
			7-0	6-0	5-0	4-0	3-0	2-0
DSM19 19mm 3/8 Circle  PS-2 P-12	Green Braided Uncoated	18"/45cm				F683N X683G •		
DSM24 24mm 3/8 Circle  FS-1 C-14	White Braided Uncoated	18"/45cm				F647D R647H •		
DSM26 26mm 3/8 Circle  FS C-15	White Braided Uncoated	18"/45cm					F665D R665H •	

Product numbers are color coded respectively as Sharpoint™ PLUS (dark blue), comparable Ethicon™ (black), and comparable Syneture™ (green).

• indicates that other manufacturers do not have a comparable product code or needle.

N=box of 12; D=box of 36; S=SmallStitch™ suture lengths of 8"-10".

Product Index

Code	Size	Material	Page Number
A0556N	5-0	Nylon, Black Monofilament	19
A0616N	2-0	Nylon, Blue Monofilament	20
A0620N	1	Nylon, Blue Monofilament	20
A1328N	3-0	Nylon, Blue Monofilament	20
A1611N	4-0	Nylon, Clear Monofilament	20
A1629N	4-0	Nylon, Black Monofilament	20
A1662N	4-0	Nylon, Black Monofilament	20
A1663N	3-0	Nylon, Black Monofilament	20
A1666N	5-0	Nylon, Black Monofilament	20
A1666NS	5-0	Nylon, Black Monofilament	20
A1667N	4-0	Nylon, Black Monofilament	20
A1667NS	4-0	Nylon, Black Monofilament	20
A1668N	5-0	Nylon, Black Monofilament	19
A1669N	3-0	Nylon, Black Monofilament	20
A1671N	4-0	Nylon, Clear Monofilament	20
A1696N	7-0	Nylon, Black Monofilament	19
A1864N	4-0	Nylon, Black Monofilament	19
A1865N	5-0	Nylon, Black Monofilament	19
A1965N	5-0	Nylon, Black Monofilament Pliable	19
A2506N	3-0	Nylon, Clear Monofilament	20
A2557NS	6-0	Nylon, Black Monofilament	19
A2558NS	5-0	Nylon, Black Monofilament	19
A5666D	5-0	Nylon, Black Monofilament	20
A661N	5-0	Nylon, Black Monofilament	20
A661NS	5-0	Nylon, Black Monofilament	20
A662D	4-0	Nylon, Black Monofilament	20
A662N	4-0	Nylon, Black Monofilament	20
A662NS	4-0	Nylon, Black Monofilament	20
A663N	3-0	Nylon, Black Monofilament	20
A664N	2-0	Nylon, Black Monofilament	20
A667N	6-0	Nylon, Black Monofilament	19
A669N	3-0	Nylon, Black Monofilament	20
A691N	4-0	Nylon, Clear Monofilament	19
A697N	6-0	Nylon, Black Monofilament	19
A697NS	6-0	Nylon, Black Monofilament	19
A8685N	2-0	Nylon, Blue Monofilament	20
A911NS	6-0	Nylon, Black Monofilament	19
A913NS	5-0	Nylon, Black Monofilament	19
A921N	4-0	Nylon, Black Monofilament	19
A931NS	4-0	Nylon, Black Monofilament	19

Product Index

Code	Size	Material	Page Number
A947NS	4-0	Nylon, Black Monofilament	20
B0500N	5-0	Plain Gut	7
B0593N	3-0	Plain Gut	7
B0599N	4-0	Plain Gut	7
B2463N	4-0	Plain Gut	7
B2698N	6-0	Plain Gut	7
B521NS	5-0	Plain Gut	7
B537N	4-0	Plain Gut	7
B592N	30-	Plain Gut	7
B612N	3-0	Plain Gut	7
B660N	6-0	Plain Gut	7
B686N	5-0	Plain Gut	7
B770N	6-0	Plain Gut	7
B774N	6-0	Plain Gut	7
B810N	3-0	Plain Gut	7
B820N	5-0	Plain Gut	7
B821N	4-0	Plain Gut	7
B822N	3-0	Plain Gut	7
B823N	2-0	Plain Gut	7
C0562N	0	Chromic Gut	8
C0563N	5-0	Chromic Gut	8
C0935N	5-0	Chromic Gut	8
C100N	3-0	Chromic Gut	8
C1636N	5-0	Chromic Gut	8
C1637N	4-0	Chromic Gut	8
C1638N	3-0	Chromic Gut	8
C1642N	5-0	Chromic Gut	9
C1653N	4-0	Chromic Gut	9
C525N	3-0	Chromic Gut	8
C558N	4-0	Chromic Gut	8
C634N	5-0	Chromic Gut	8
C635N	4-0	Chromic Gut	8
C636N	3-0	Chromic Gut	8
C637N	2-0	Chromic Gut	8
C687N	5-0	Chromic Gut	8
C792N	5-0	Chromic Gut	8
C796N	6-0	Chromic Gut	8
D0208N	4-0	Silk, Black Braided	17
D0212N	3-0	Silk, Black Braided	17
D0213N	2-0	Silk, Black Braided	18

Product Index

Code	Size	Material	Page Number
D0238N	2-0	Silk, Black Braided	17
D0239N	4-0	Silk, Black Braided	17
D0389N	3-0	Silk, Black Braided	17
D0423N	1	Silk, Black Braided	18
D0765N	3-0	Silk, Black Braided	18
D0768N	3-0	Silk, Black Braided	17
D0775N	3-0	Silk, Black Braided	17
D0783N	3-0	Silk, Black Braided	18
D1639N	6-0	Silk, Black Braided	17
D1677N	4-0	Silk, Black Braided	17
D1679N	3-0	Silk, Black Braided	17
D2460N	3-0	Silk, Black Braided	18
D629N	4-0	Silk, Black Braided	17
D632N	3-0	Silk, Black Braided	18
D639N	6-0	Silk, Black Braided	17
D675N	3-0	Silk, Black Braided	18
D678N	0	Silk, Black Braided	18
D679N	2-0	Silk, Black Braided	18
D680N	0	Silk, Black Braided	18
D682N	5-0	Silk, Black Braided	17
D683N	4-0	Silk, Black Braided	17
D684N	3-0	Silk, Black Braided	17
D685N	2-0	Silk, Black Braided	17
D734N	4-0	Silk, Black Braided	18
D777N	4-0	Silk, Black Braided	18
D778N	3-0	Silk, Black Braided	18
D779N	5-0	Silk, Black Braided	18
D782N	3-0	Silk, Black Braided	18
F647D	3-0	Polyviolene™/Polyester, White Braided Uncoated	23
F665D	2-0	Polyviolene™/Polyester, White Braided Uncoated	23
F683N	4-0	Polyviolene™/Polyester, Green Braided Uncoated	23
G0322N	3-0	PolySyn™/Polyglycolic Acid, Violet Braided	16
G0392N	4-0	PolySyn™/Polyglycolic Acid, Violet Braided	14
G0417N	2-0	PolySyn™/Polyglycolic Acid, Undyed Braided	16
G0508N	3-0	PolySyn™/Polyglycolic Acid, Undyed Braided	13
G0518N	0	PolySyn™/Polyglycolic Acid, Violet Braided	16
G232N	3-0	PolySyn™/Polyglycolic Acid, Undyed Braided	16
G260N	0	PolySyn™/Polyglycolic Acid, Undyed Braided	16
G269N	2-0	PolySyn™/Polyglycolic Acid, Undyed Braided	16
G310N	4-0	PolySyn™/Polyglycolic Acid, Violet Braided	15
G311N	3-0	PolySyn™/Polyglycolic Acid, Violet Braided	15

Product Index

Code	Size	Material	Page Number
G316N	3-0	PolySyn™/Polyglycolic Acid, Violet Braided	16
G323N	2-0	PolySyn™/Polyglycolic Acid, Violet Braided	16
G332N	3-0	PolySyn™/Polyglycolic Acid, Violet Braided	16
G333N	2-0	PolySyn™/Polyglycolic Acid, Violet Braided	16
G339N	2-0	PolySyn™/Polyglycolic Acid, Violet Braided	16
G340N	0	PolySyn™/Polyglycolic Acid, Violet Braided	16
G341N	1	PolySyn™/Polyglycolic Acid, Violet Braided	16
G352N	0	PolySyn™/Polyglycolic Acid, Violet Braided	16
G354N	2-0	PolySyn™/Polyglycolic Acid, Violet Braided	16
G359N	1	PolySyn™/Polyglycolic Acid, Violet Braided	16
G392N	4-0	PolySyn™/Polyglycolic Acid, Violet Braided	14
G393N	3-0	PolySyn™/Polyglycolic Acid, Violet Braided	14
G421N	5-0	PolySyn™/Polyglycolic Acid, Undyed Braided	14
G422D	4-0	PolySyn™/Polyglycolic Acid, Undyed Braided	14
G422N	4-0	PolySyn™/Polyglycolic Acid, Undyed Braided	14
G423N	3-0	PolySyn™/Polyglycolic Acid, Undyed Braided	14
G426N	4-0	PolySyn™/Polyglycolic Acid, Undyed Braided	14
G427N	3-0	PolySyn™/Polyglycolic Acid, Undyed Braided	14
G433N	5-0	PolySyn™/Polyglycolic Acid, Undyed Braided	15
G441N	4-0	PolySyn™/Polyglycolic Acid, Undyed Braided	14
G442N	3-0	PolySyn™/Polyglycolic Acid, Undyed Braided	14
G443D	2-0	PolySyn™/Polyglycolic Acid, Undyed Braided	14
G443N	2-0	PolySyn™/Polyglycolic Acid, Undyed Braided	14
G451N	4-0	PolySyn™/Polyglycolic Acid, Violet Braided	14
G480N	1	PolySyn™/Polyglycolic Acid, Violet Braided	15
G486N	1	PolySyn™/Polyglycolic Acid, Violet Braided	15
G489NS	6-0	PolySyn™/Polyglycolic Acid, Undyed Braided	13
G490N	5-0	PolySyn™/Polyglycolic Acid, Undyed Braided	13
G493NS	5-0	PolySyn™/Polyglycolic Acid, Undyed Braided	13
G495N	5-0	PolySyn™/Polyglycolic Acid, Undyed Braided	14
G495NS	5-0	PolySyn™/Polyglycolic Acid, Undyed Braided	14
G496N	4-0	PolySyn™/Polyglycolic Acid, Undyed Braided	14
G496NS	4-0	PolySyn™/Polyglycolic Acid, Undyed Braided	14
G497N	3-0	PolySyn™/Polyglycolic Acid, Undyed Braided	14
G500N	5-0	PolySyn™/Polyglycolic Acid, Undyed Braided	13
G503N	5-0	PolySyn™/Polyglycolic Acid, Undyed Braided	14
G506N	5-0	PolySyn™/Polyglycolic Acid, Undyed Braided	14
G507N	4-0	PolySyn™/Polyglycolic Acid, Undyed Braided	14
G532N	2-0	PolySyn™/Polyglycolic Acid, Violet Braided	15
G551N	6-0	PolySyn™/Polyglycolic Acid, Violet Braided	13

Product Index

Code	Size	Material	Page Number
G683N	3-0	PolySyn™/Polyglycolic Acid, Undyed Braided	14
G691D	4-0	PolySyn™/Polyglycolic Acid, Undyed Braided	14
G714N	4-0	PolySyn™/Polyglycolic Acid, Undyed Braided	15
G835N	4-0	PolySyn™/Polyglycolic Acid, Undyed Braided	13
G839N	2-0	PolySyn™/Polyglycolic Acid, Undyed Braided	16
G945N	2-0	PolySyn™/Polyglycolic Acid, Undyed Braided	16
J1013NS	5-0	Polypropylene, Blue Monofilament	21
J1058NS	5-0	Polypropylene, Blue Monofilament	21
J1078NS	5-0	Polypropylene, Blue Monofilament	21
J1239N	3-0	Polypropylene, Blue Monofilament	22
J661N	5-0	Polypropylene, Blue Monofilament	21
J683N	4-0	Polypropylene, Blue Monofilament	21
J8424N	0	Polypropylene, Blue Monofilament	22
J8629N	4-0	Polypropylene, Blue Monofilament	22
J8635N	5-0	Polypropylene, Blue Monofilament	21
J8661N	5-0	Polypropylene, Blue Monofilament	21
J8663N	3-0	Polypropylene, Blue Monofilament	22
J8665N	3-0	Polypropylene, Blue Monofilament	21
J8681N	5-0	Polypropylene, Blue Monofilament	21
J8682N	4-0	Polypropylene, Blue Monofilament	21
J8682NS	4-0	Polypropylene, Blue Monofilament	21
J8683D	4-0	Polypropylene, Blue Monofilament	21
J8683N	4-0	Polypropylene, Blue Monofilament	21
J8685N	2-0	Polypropylene, Blue Monofilament	22
J8686N	5-0	Polypropylene, Blue Monofilament	21
J8687N	3-0	Polypropylene, Blue Monofilament	21
J8694N	5-0	Polypropylene, Blue Monofilament	21
J8695N	6-0	Polypropylene, Blue Monofilament	21
J8696N	7-0	Polypropylene, Blue Monofilament	21
J8697N	6-0	Polypropylene, Blue Monofilament	21
J8697NS	6-0	Polypropylene, Blue Monofilament	21
J8698N	5-0	Polypropylene, Blue Monofilament	21
M0423N	3-0	PolySyn FA™/Polyglycolic Acid, Undyed Braided	10
M214N	4-0	PolySyn FA™/Polyglycolic Acid, Undyed Braided	10
M426N	4-0	PolySyn FA™/Polyglycolic Acid, Undyed Braided	10
M442N	3-0	PolySyn FA™/Polyglycolic Acid, Undyed Braided	10
M456N	3-0	PolySyn FA™/Polyglycolic Acid, Undyed Braided	10
M490N	5-0	PolySyn FA™/Polyglycolic Acid, Undyed Braided	10
M496N	4-0	PolySyn FA™/Polyglycolic Acid, Undyed Braided	10
M497N	3-0	PolySyn FA™/Polyglycolic Acid, Undyed Braided	10
Y426N	4-0	Monoderm™, Undyed Monofilament	11

Product Index

Code	Size	Material	Page Number
Y427N	3-0	Monoderm™, Undyed Monofilament	11
Y432N	6-0	Monoderm™, Undyed Monofilament	12
Y433N	5-0	Monoderm™, Undyed Monofilament	12
Y434N	4-0	Monoderm™, Undyed Monofilament	12
Y463N	5-0	Monoderm™, Violet Monofilament	11
Y464N	4-0	Monoderm™, Violet Monofilament	11
Y489N	6-0	Monoderm™, Undyed Monofilament	11
Y490N	5-0	Monoderm™, Undyed Monofilament	11
Y490NS	5-0	Monoderm™, Undyed Monofilament	11
Y492N	6-0	Monoderm™, Undyed Monofilament	11
Y493N	5-0	Monoderm™, Undyed Monofilament	11
Y494N	4-0	Monoderm™, Undyed Monofilament	11
Y495N	5-0	Monoderm™, Undyed Monofilament	11
Y495NS	5-0	Monoderm™, Undyed Monofilament	11
Y496N	4-0	Monoderm™, Undyed Monofilament	11
Y496NS	4-0	Monoderm™, Undyed Monofilament	11
Y497N	3-0	Monoderm™, Undyed Monofilament	11
Y497NS	3-0	Monoderm™, Undyed Monofilament	11
Y503N	5-0	Monoderm™, Undyed Monofilament	12
Y504N	4-0	Monoderm™, Undyed Monofilament	12
Y513N	4-0	Monoderm™, Violet Monofilament	11
Y682N	4-0	Monoderm™, Undyed Monofilament	12
Y822N	5-0	Monoderm™, Undyed Monofilament	11
Y823N	4-0	Monoderm™, Undyed Monofilament	11
Y823NS	4-0	Monoderm™, Undyed Monofilament	11
Y833N	6-0	Monoderm™, Undyed Monofilament	11
Y844N	5-0	Monoderm™, Undyed Monofilament	11
Y844NS	5-0	Monoderm™, Undyed Monofilament	11
Y845N	4-0	Monoderm™, Undyed Monofilament	11
Y845NS	4-0	Monoderm™, Undyed Monofilament	11
Y936N	3-0	Monoderm™, Undyed Monofilament	12

Visit SurgicalSpecialties.com And Click "Find A Product" For SKUs And Cross-Reference Information.

Surgical Specialties Corporation, 50 Braintree Hill Office Park, Suite 101, Braintree, MA 02184, U.S.A.
Phone: 610.404.3520 • 877.991.1110 (USA and Canada only) • Fax: 610.404.4010
All trademarks are property of their respective owners. ©2015 Surgical Specialties Corporation.
All Rights Reserved. SSC-028 R1 9/15

**SURGICAL
SPECIALTIES**
CORPORATION™