

Connex[®] Spot Monitor



Directions for use

Software version 1.X

WelchAllyn[®]

Advancing Frontline Care[™]

© 2015 Welch Allyn. All rights are reserved. To support the intended use of the product described in this publication, the purchaser of the product is permitted to copy this publication, for internal distribution only, from the media provided by Welch Allyn. No other use, reproduction, or distribution of this publication, or any part of it, is permitted without written permission from Welch Allyn. Welch Allyn assumes no responsibility for any injury to anyone, or for any illegal or improper use of the product, that may result from failure to use this product in accordance with the instructions, cautions, warnings, or statement of intended use published in this manual.

Welch Allyn, Connex, SureTemp, FlexiPort, and SureBP are registered trademarks of Welch Allyn.

EcoCuff is a trademark of Welch Allyn.

LNCS, ReSposable, SET, LNOP, and Masimo are registered trademarks of Masimo Corporation. Possession or purchase of a Masimo SpO₂-equipped device does not convey any express or implied license to use the device with unauthorized sensors or cables which would, alone or in combination with this device, fall within the scope of one or more of the patents relating to this device.

For Masimo patent information, please visit www.masimo.com/patents.htm.

Nellcor™ SpO₂ Patient Monitoring System with OxiMax™ Technology and Nellcor™ SpO₂ OxiMax™ Technology are registered trademarks of COVIDIEN LP Covidien Holdings Inc.

Braun and ThermoScan are registered trademarks of Braun GmbH.

Nonin is a registered trademark of Nonin Medical, Inc.

The *Bluetooth*® word mark and logos are registered trademarks owned by *Bluetooth*SIG, Inc. and any use of such marks by Welch Allyn is under license.

Software in this product is Copyright 2015 Welch Allyn or its vendors. All rights are reserved. The software is protected by United States of America copyright laws and international treaty provisions applicable worldwide. Under such laws, the licensee is entitled to use the copy of the software incorporated with this instrument as intended in the operation of the product in which it is embedded. The software may not be copied, decompiled, reverse-engineered, disassembled, or otherwise reduced to human-perceivable form. This is not a sale of the software or any copy of the software; all right, title, and ownership of the software remain with Welch Allyn or its vendors.

This product may contain software known as “free” or “open source” software (FOSS). Welch Allyn uses and supports the use of FOSS. We believe that FOSS makes our products more robust and secure, and gives us and our customers greater flexibility. To learn more about FOSS that may be used in this product, please visit our FOSS website at www.welchallyn.com/opensource. Where required, a copy of FOSS source code is available on our FOSS website.

For patent information, please visit www.welchallyn.com/patents.

For information about any Welch Allyn product, contact your local Welch Allyn representative: www.welchallyn.com/about/company/locations.htm.

DIR 80019224 Ver. L Revised 2015-05

This manual applies to

REF

 901058 Vital Signs Monitor Core.



Welch Allyn, Inc.
4341 State Street Road
Skaneateles Falls, NY 13153 USA

www.welchallyn.com

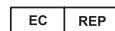

Regulatory Affairs Representative
Welch Allyn Limited
Navan Business Park
Dublin Road
Navan, County Meath
Republic of Ireland



Advancing Frontline Care™

Contents

Introduction	1
Intended use	1
Contraindications	1
 Symbols and definitions	 3
 About warnings and cautions	 7
General warnings and cautions	7
 Controls, indicators, and connectors	 13
 Setup	 19
Supplies and accessories	19
Connect the battery	19
Mount the monitor	20
Attach the probe well and temperature probe	21
Remove the temperature probe and probe well	22
Connect the NIBP hose	22
Disconnect the NIBP hose	22
Connect the SpO2 cable	22
Disconnect the SpO2 cable	22
Attach an accessory	22
Detach an accessory	23
Disconnect AC power	23
 Startup	 25
Power	25
Login methods	30
Profiles	31
Common screen functionality	35
Primary screens	36
Pop-up screens	39
Navigation	39
 Patient data management	 43
Load patient data with the barcode scanner	43
Add a patient	44
Manage patient records	44
Modifiers	45
 Alarms	 47
Vital sign summary view	47

Alarm limits	47
Alarm reminder signal	47
Alarm types	47
Alarm notification locations	48
Icons on the Home tab	48
Reset (pause or turn off) audio alarms	50
Adjust vital sign alarm limits	51
Modify audio alarm notification	51
Alarm messages and priorities	52
Nurse Call	53
Patient monitoring	55
Required parameters	55
Intervals	56
NIBP	59
Temperature	62
SpO2	71
Modifiers and manual parameters	76
Configuration tool	77
Custom scoring	77
Advanced settings	77
Maintenance and service	79
Perform periodic checks	79
Replace the monitor battery	79
Replace the APM work surface battery	80
Cleaning requirements	81
Troubleshooting	87
NIBP messages	87
SpO2 messages	93
Temperature messages	104
Patient and clinician data messages	112
Radio messages	114
Connectivity messages	120
System messages	121
Software update messages	123
Bluetooth® messages	124
APM messages	125
Specifications	127
Physical specifications	127
Environmental specifications	134
Monitor radio	134
Bluetooth® module	135
Configuration options	136
Standards and compliance	137
General compliance and standards	137
General radio compliance	138

Guidance and manufacturer's declaration	143
EMC compliance	143
Emissions and immunity information	143
Appendices	147
Approved accessories	147
Warranty	155

Introduction

This manual describes the capabilities and operation of the Connex Spot Monitor (monitor). The information, including the illustrations, pertains to a monitor configured with noninvasive blood pressure (NIBP), body temperature, pulse oximetry (SpO₂), and pulse rate. If your monitor configuration lacks any of these options, some information in this manual might not apply.

Before using the monitor, read the sections of the manual that pertain to your use of the monitor.

Intended use

The Connex Spot Monitors (monitor) are intended to be used by clinicians and medically qualified personnel for monitoring of noninvasive blood pressure, pulse rate, noninvasive functional oxygen saturation of arteriolar hemoglobin (SpO₂), and body temperature in normal and axillary modes of neonatal, pediatric and adult patients.

The most likely locations for patients to be monitored are general medical or surgical floors and general hospital and alternate care environments.

This product is available for sale only upon the order of a physician or licensed health care professional.

Contraindications

This system is not intended to be used:

- on patients connected to heart/lung machines
- on patients being transported outside a healthcare facility
- near an MRI machine
- in a hyperbaric chamber
- near flammable anesthetics
- near electro-cauterization devices

For contraindications of SpO₂ sensors, consult the sensor manufacturer's directions for use.

Symbols and definitions

Documentation symbols



WARNING The warning statements in this manual identify conditions or practices that could lead to illness, injury, or death. Warning statements appear with a grey background in a black and white document.



CAUTION The caution statements in this manual identify conditions or practices that could result in damage to the equipment or other property, or loss of data. This definition applies to both yellow and black and white symbols.



Follow instructions/directions for use (DFU) -- mandatory action.
A copy of the DFU is available on this website.
A printed copy of the DFU can be ordered from Welch Allyn for delivery within 7 calendar days.

Power symbols



Power button



Equipotential ground



(on the display) Power plug



Battery absent or faulty



(on the monitor, green indicator) Alternating Current power present, battery fully charged



Battery charge level



(on the monitor, amber indicator) Alternating Current power present, battery is charging





Battery







Alternating Current (AC)













Rechargeable battery











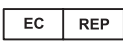

	Rated power input, DC		Rated power input, AC
Li-ion	Lithium-ion battery		Direct current (DC)

Connectivity symbols

	Bluetooth®		Ethernet RJ-45
	USB		Nurse call
	Wireless signal strength <ul style="list-style-type: none"> • Best (4 bars) • Good (3 bars) • Fair (2 bars) • Weak (1 bar) • No signal (no bars) • No connection (blank) 		

Miscellaneous symbols

	Manufacturer		Defibrillation-proof Type BF applied parts
	Product Identifier		Serial number
	Reorder number		China RoHS markings for control of pollution caused by electronic information products. XX indicates Environmentally Friendly Use Period in years.
	Do not reuse		Recycle the product separate from other disposables
	Nonionizing electromagnetic radiation		Call for maintenance

	Light below	R_x ONLY	Prescription only
FCC ID	The identification number assigned by the Federal Trade Commission	IC ID	Industry Canada identification number. The equivalent governing body to the FCC in the United States
	This end up		Fragile
	European Community Representative		Meets essential requirements of European Medical Device Directive 93/42/EEC
IPX1	IP = International Protection Marking X = No object ingress rating 1 = Protected against vertically dripping water		Australian Regulatory Compliance Mark
	Intertek ETL Listed Mark indicating successful independent safety testing		Recycle
	Temperature range		Global Trade Identification Number
	Stacking limit by number		Keep dry
	Humidity range		

Screen symbol



Process indicator for activities like acquiring measurements and connecting to a laptop

About warnings and cautions

Warning and caution statements can appear on the monitor, on the packaging, on the shipping container, or in this document.

The monitor is safe for patients and clinicians when used in accordance with the instructions and the warning and caution statements presented in this manual.

Before using the monitor, familiarize yourself with the sections of this directions for use that pertain to your use of the monitor.



WARNING The warning statements in this manual identify conditions or practices that could lead to illness, injury, or death.



CAUTION The caution statements in this manual identify conditions or practices that could result in damage to the equipment or other property, or loss of patient data.

General warnings and cautions



WARNING Patient injury risk. Many environmental variables, including patient physiology and clinical application, can affect the accuracy and performance of the monitor. The clinician must verify all vital signs information before treating the patient. If there is any question about the accuracy of a measurement, verify the measurement using another clinically accepted method.



WARNING Patient injury risk. To ensure data integrity and patient confidentiality, save readings and clear the monitor's display between patients.



WARNING Personal injury risk. The power cord is the disconnect device to isolate this equipment from supply mains. Position the equipment so that it is not difficult to reach or disconnect the cord.



WARNING Patient injury risk. Damaged cords, cables, and accessories can affect patient and operator safety. Never lift the monitor by the power supply cord or patient connections. Routinely inspect the AC power cord, blood pressure cuff, SpO2 cable, and other accessories for strain relief wear, fraying, or other damage. Replace as necessary.



WARNING Patient injury risk. During defibrillation, keep discharge paddles away from the monitor ECG lead wires, electrodes, any other monitor sensors, and other conductive parts in contact with the patient.



WARNING Patient injury risk. Any external compression of the blood pressure hose or cuff may cause patient injury, system errors, or inaccurate measurements.



WARNING Patient injury risk. Wash hands to reduce the risk of cross-contamination and nosocomial infection.



WARNING Patient injury risk. Do not place the monitor in any position that might cause it to fall on the patient.



WARNING Patient injury risk. Verify patient identity on the monitor after manual or barcode entry and before printing or transferring patient records. Failure to identify the correct patient can result in patient injury.



WARNING Equipment failure and patient injury risk. Do not cover the air intake or exhaust vents on the rear and base of the monitor. Covering these vents could cause overheating of the monitor or muffling of alarms.



WARNING This equipment is not suitable for use in the presence of electro-surgery.



WARNING For operator and patient safety, peripheral equipment and accessories that can come in direct patient contact must comply with all applicable safety, EMC, and regulatory requirements.



WARNING Equipment damage and personal injury risk. When transporting the monitor on a mobile stand, properly secure all patient cables and cords to keep them clear of the wheels and to minimize trip hazards.



WARNING Equipment damage and personal injury risk. No modifications to the monitor are allowed by anyone other than a qualified Welch Allyn service representative. Modification of the monitor could be hazardous to patients and personnel.



WARNING Fire and explosion hazard. Do not operate the monitor in the presence of a flammable anesthetic mixture with air, oxygen, or nitrous oxide; in oxygen-enriched environments; or in any other potentially explosive environment.



WARNING Fire and shock hazard. Only connect LAN cables contained within the perimeter of a single building. Conductive LAN cables spanning multiple buildings may introduce fire or shock hazards unless they are fitted with fiber optic cables, lightning arresters, or other applicable safety features.



WARNING Electric shock hazard. This equipment must only be connected to a supply mains with protective earth.



WARNING Electric shock hazard. Do not open the monitor or attempt repairs. The monitor has no user-serviceable internal parts. Only perform routine cleaning and maintenance procedures specifically described in this manual. Inspection and servicing of internal parts shall only be performed by qualified service personnel.



WARNING Electric shock hazard. All signal input and output (I/O) connectors are intended for connection of only devices complying with IEC 60601-1, or other IEC standards (for example, IEC 60950), as applicable to the monitor. Connecting additional devices to the monitor may increase chassis or patient leakage currents. To maintain operator and patient safety, consider the requirements of IEC 60601-1-1. Measure the leakage currents to confirm that no electric shock hazard exists.



WARNING Explosion or contamination hazard. Improper disposal of batteries may create an explosion or contamination hazard. Never dispose of batteries in refuse containers. Always recycle batteries according to local regulations.



WARNING Use the monitor only as described in this directions for use. Do not use the monitor on patients as described in the Contraindications.



WARNING Alarm limits are patient- or facility-specific. The clinician must set or verify alarm limits appropriate for each patient. Each time the monitor is powered on, you must check that the alarm settings are appropriate for your patient before you start monitoring.



WARNING Inaccurate measurement risk. The monitor is not intended for use during patient transport outside of the medical facility. Do not use the monitor to take measurements on any patient in transit.



WARNING Inaccurate measurement risk. Do not connect more than one patient to a monitor.



WARNING Inaccurate measurement risk. Dust and particle ingress can affect the accuracy of blood pressure measurements. Use the monitor in clean environments to ensure measurement accuracy. If you notice dust or lint build-up on the monitor's vent openings, have the monitor inspected and cleaned by a qualified service technician.



WARNING Inaccurate measurement risk. Do not expose to temperatures higher than 122° F (50° C).



WARNING Inaccurate measurement risk. Do not use the monitor on patients who are on heart-lung machines.



WARNING Inaccurate measurement risk. Do not use the monitor on patients who are experiencing convulsions or tremors.



WARNING Liquids can damage electronics inside the monitor. Prevent liquids from spilling on the monitor.

If liquids are spilled on the monitor:

1. Power down the monitor.
2. Disconnect the power plug.
3. Remove battery pack from the monitor.
4. Dry off excess liquid from the monitor.

Note If liquids possibly entered the monitor, remove the monitor from use until it has been properly dried, inspected, and tested by qualified service personnel.

5. Reinstall battery pack.
6. Reconnect the power plug.
7. Power on the monitor and verify that the monitor functions normally before using it.



WARNING The monitor may not function properly if dropped or damaged. Protect it from severe impact and shock. Do not use the monitor if you notice any signs of damage. Qualified service personnel must check any monitor that is dropped or damaged for proper operation before putting the monitor back into use.



WARNING Defective batteries can damage the monitor. If the battery shows any signs of damage or cracking, it must be replaced immediately and only with a battery approved by Welch Allyn.



WARNING Personal injury risk. Improper handling of the battery can lead to heat generation, smoke, explosion or fire. Do not short-circuit, crush, incinerate, or disassemble the battery. Never dispose of batteries in refuse containers. Always recycle batteries according to national or local regulations.



WARNING Use only Welch Allyn approved accessories, and use them according to the manufacturer's directions for use. Using unapproved accessories with the monitor can affect patient and operator safety and can compromise product performance and accuracy, and void the product warranty.



WARNING Wall mounted equipment and accessories must be installed in accordance with accompanying instructions. Welch Allyn is not responsible for the integrity of any installation not performed by authorized Welch Allyn service personnel. Contact an authorized Welch Allyn service representative or other qualified service personnel to ensure professional installation for safety and reliability of any mounting accessory.



WARNING Welch Allyn is not responsible for the integrity of a facility's power. If the integrity of a facility's power or protective earth conductor is in doubt, always operate the monitor on battery power alone when it is attached to a patient.



CAUTION Electric shock hazard. Do not sterilize the monitor. Sterilizing the monitor could damage the device.



CAUTION United States Federal law restricts this monitor to sale, distribution, or use by or on the order of a physician or licensed healthcare professional.



CAUTION Electromagnetic interference risk. The monitor complies with applicable domestic and international standards for electromagnetic interference. These standards are intended to minimize medical equipment electromagnetic interference. Although this monitor is not expected to present problems to other compliant equipment or be affected by other compliant devices, interference issues still may occur. As a precaution, avoid using the monitor in close proximity to other equipment. In the event that equipment interference is observed, relocate the equipment as necessary or consult manufacturer's directions for use.



CAUTION Do not move the stand while the power source is plugged into the mains outlet.



CAUTION Do not sterilize the monitor. Sterilizing the monitor could harm the device.



CAUTION Use only a Class I (grounded) AC power cord to charge the power source for the monitor.



CAUTION Do not use a long press of  to power down the monitor when it is functioning normally. You will lose patient data and configuration settings.



CAUTION Never move the monitor or mobile stand by pulling on any of the cords. This may cause the monitor to tip over or damage the cord. Never pull on the power cord when disconnecting the cord from the mains outlet. When disconnecting the power cord, always grasp the attachment plug. Keep the cord away from liquids, heat, and sharp edges. Replace the power cord if the strain relief, cord insulation, or metal prongs are damaged or begin to separate from the attachment plug.



CAUTION Use only the Welch Allyn USB client cable to connect a laptop computer to the USB client port. Any laptop connected to the monitor must be running on a battery, a 60601-1 compliant power supply, or a 60601-1 compliant isolation transformer.



CAUTION If the touchscreen is not responding properly, refer to the troubleshooting section. If the problem cannot be resolved, discontinue use of the monitor and contact an authorized Welch Allyn service center or qualified service personnel.

Controls, indicators, and connectors

Note Your model might not contain all of these features.

Front-Left view

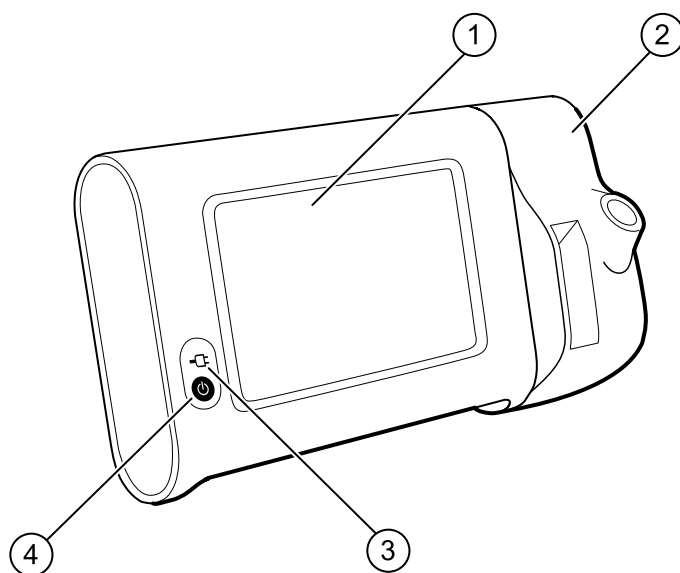

No.	Feature	Description
1	LCD screen	7" color touchscreen provides a graphical user interface.
2	Thermometry	Secures the SureTemp unit to the monitor
3	Battery charge and power-up status indicator	The LED indicates the charging and power-up status when connected to AC power: <ul style="list-style-type: none"> • Green: The battery is charged. • Amber: The battery is charging. • Flashing: the monitor is powering up.
4	Power button	Blue button on lower-left corner of the monitor. <ul style="list-style-type: none"> • Powers on the monitor • Places into Sleep mode, except when an alarm condition is active (brief press)

No.	Feature	Description
		<ul style="list-style-type: none">• Wakes up the monitor from Sleep mode

Back-Bottom-Left view

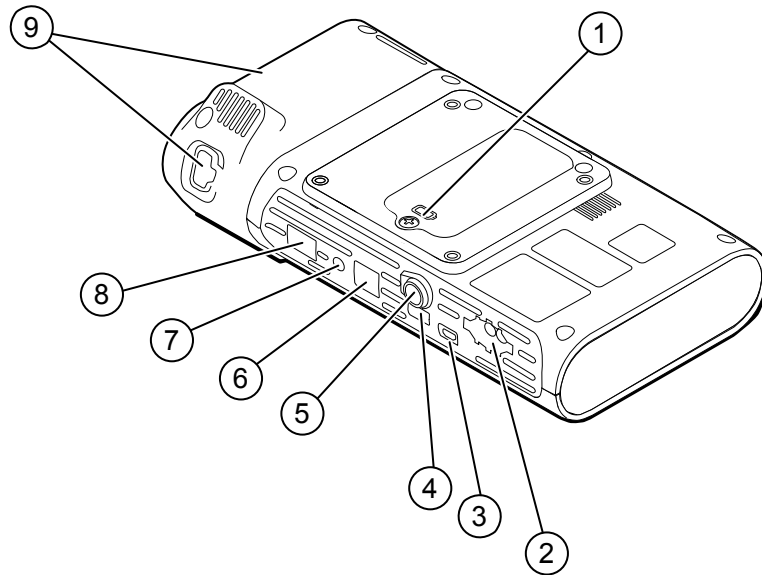

No.	Feature	Description
1	Battery compartment (behind cover)	Houses the battery (captive screw secures cover to monitor)
2	NIBP	Connects NIBP cable to monitor
3	USB client port	Provides a connection to an external computer for testing and software upgrades
4	USB port	Connects APM work surface to monitor
5	Power connection	Connects APM work surface or any accessory to the monitor
6	Ethernet RJ-45	Provides a hardwired connection to the computer network
7	Nurse call	Provides a connection to a hospital nurse call system
8	SpO2	Connects chosen SpO2 system to monitor
9	Thermometry	Configuration shown features SureTemp module and probe connection port

APM

This section applies only to devices with an Accessory Power Management (APM) stand. The APM is an accessory stand with work surface, power supply for enhanced device run time, and organizational bins to arrange sensors and cables for available parameters.

Front-Top-Left view

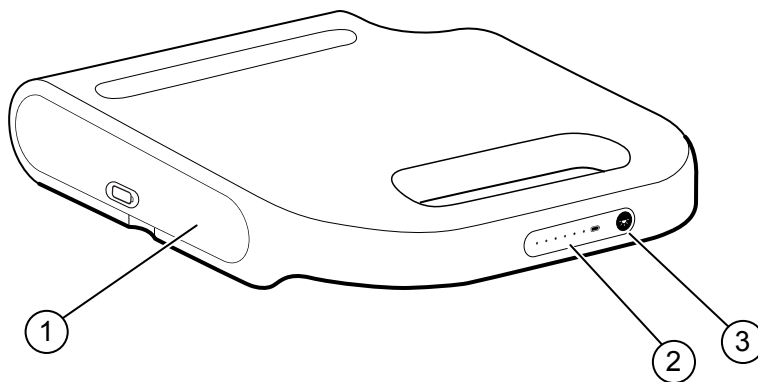

No.	Feature	Description
1	Battery compartment (behind cover)	Houses the battery
2	Battery charge status indicator	Indicates charge level of battery
3	Light power switch	Powers light under APM work surface

Back-Bottom-Right view

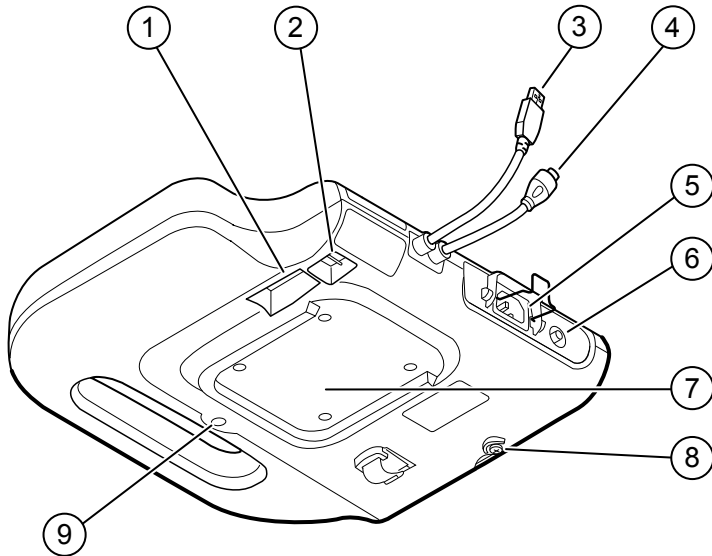

No.	Feature	Description
1	Printer port	Connect a printer (future use)
2	USB ports (2)	Connect optional accessories
3	USB cable	Connects APM work surface to monitor
4	APM power cable	Connects APM work surface to monitor
5	Power connection	Provides an external AC power connection
6	Ground lug (equipotential terminal)	Provided for electrical safety testing and for connecting a potential-equalization conductor
7	Recess for mounting	Secures the APM work surface when it is mounted on the APM stand (with 4 screws)
8	Battery cover screw	Secures APM work surface battery cover
9	APM light	Illuminates accessory bins and path for APM stand

Setup

Supplies and accessories

For a list of all approved supplies and accessories, see *Approved Accessories* in the Appendices.



WARNING Patient injury risk. Clean all accessories, including cables and tubes, before storing the accessories on the device or cart. This helps reduce the risk of cross contamination and nosocomial infection. Refer to 'Clean the equipment' in "Maintenance and service" for directions.

Connect the battery

This procedure applies to first-time setup of the monitor. The battery is inserted in the battery compartment when you receive a new monitor. However, it is not connected.



WARNING Personal injury risk. Improper handling of the battery can lead to heat generation, smoke, explosion, or fire. Do not short-circuit, crush, incinerate, or disassemble the battery. Never dispose of batteries in refuse containers. Always recycle batteries according to national or local regulations.



WARNING Use only Welch Allyn approved accessories, and use them according to the manufacturer's directions for use. Using unapproved accessories with the monitor can affect patient and operator safety and can compromise product performance and accuracy, and void the product warranty.

1. Turn the monitor screen down to access the battery cover.
2. Locate the battery cover, indicated by  on the back of the monitor.
3. Using a double-slotted screwdriver, loosen the captive screw at the base of the battery cover, and then remove the cover.
4. Remove the battery to access the battery connection port on the monitor.
5. Insert the battery connector into the battery connection port on the monitor.
6. Insert the battery into the battery compartment.
7. Replace the battery cover, and then tighten the captive screw at the bottom of the battery cover.

Note Do not over-tighten the screw.

Mount the monitor

The Connex Spot Monitor can be mounted on either the MS3 Connex Spot Classic Mobile Stand, Accessory Power Management (APM) stand, or wall mount. When mounted on an MS3 stand, a separate power supply is required. This power supply connects directly to the mains outlet. Follow the assembly instructions or directions for use included with your stand or wall mount. If you have an APM stand, follow all instructions regarding the equipotential terminal.

Connect AC power to a power source

You can use the monitor with power from the mains outlet. Battery power can be used after charging the battery.

Refer to the AC power directions in the *Instructions for use* that accompanied the stand to which you are mounting your monitor.

Connect AC power to APM and monitor

To connect the monitor to the APM stand, refer to the *APM Assembly instructions*.

Connect AC power to MS3 Classic stand and monitor

This section applies only to devices with Classic (MS3) stands.

1. Thread the power cable from the power supply through one of the spaces next to the pole to reach the monitor.
2. Attach the power supply to the underside of the basket using the 2 Phillips screws provided.

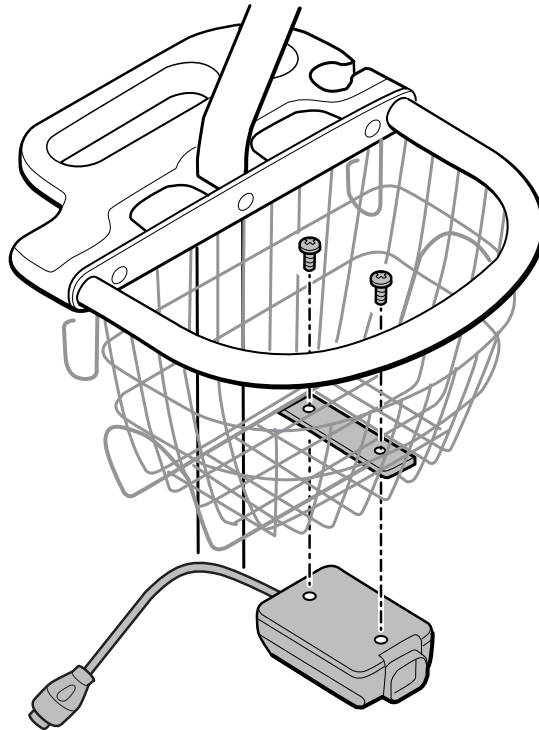

3. Connect the power cable to the monitor.
4. Connect the power cord to the mains outlet.
5. Power up the monitor.

Attach the probe well and temperature probe

1. Align the slots on the monitor and probe well, and slide the probe well onto the monitor.

The probe well snaps into place when it is fully seated.

2. On the underside of the probe well, attach the SureTemp probe connector.
3. Insert the SureTemp probe into the probe well.
4. In the compartment to the left of the probe well, insert a Welch Allyn probe cover carton.

Additional cartons of probe covers can be stored in the lower compartments of the cart if a cart is used.

Remove the temperature probe and probe well

Follow these steps to disconnect the probe cable and remove the probe well.

1. On the underside of the probe well, press the spring tab on the SureTemp probe connector and pull it out of the probe well.
2. Remove the SureTemp probe from the probe well.
3. Grasp the probe well and pull it up to remove it from the monitor.

Connect the NIBP hose

1. Place your thumb and forefinger on the hose connector spring tabs and squeeze firmly.
2. Align the hose connector with the hose connector port on the bottom of the monitor.
3. Insert the hose connector, pressing firmly until both of the spring tabs click into place.

Disconnect the NIBP hose

1. Place your thumb and forefinger on the hose connector spring tabs.

Note Always grasp the hose by the connector spring tabs. Do not pull on the hose itself.

2. Squeeze and pull the spring tabs until the connector releases.

Connect the SpO2 cable



WARNING Patient injury risk. Do not use a damaged sensor or pulse oximetry cable or a sensor with exposed electrical or optical components.

1. On the bottom of the monitor, align the SpO2 cable connector with the cable connector port.
2. Insert the cable connector, pressing firmly until the connector is seated.

Disconnect the SpO2 cable

1. Place your thumb and forefinger on the SpO2 cable connector. Do not grasp the cable.
2. Pull the SpO2 cable connector out of the connector port.

Attach an accessory



CAUTION Accessories attached to this monitor must run on battery power. Do not use any accessory's external power supply when it is attached to the monitor.

To attach an accessory to the monitor, follow the *Directions for use* that accompanied the accessory.



CAUTION Connect cables in a manner that minimizes entangling.

Detach an accessory

To detach an accessory from the monitor, follow the instructions that accompanied the accessory.

Disconnect AC power



CAUTION Never move the monitor or mobile stand by pulling on any of the cords. This may cause the monitor to tip over or damage the cord. Never pull on the power cord when disconnecting the cord from the mains outlet. When disconnecting the power cord, always grasp the attachment plug. Keep the cord away from liquids, heat, and sharp edges. Replace the power cord if the strain relief, cord insulation, or metal prongs are damaged or begin to separate from the attachment plug.

1. Grasp the attachment plug.
2. Pull the attachment plug from the mains outlet.

Startup

Power

The Power button, located on the lower-left corner of the monitor, performs multiple functions.

- Powers up the monitor
- Wakes the monitor from Sleep mode
- Opens a pop-up dialog with controls to sign out, power down, and enter Sleep mode (except when an alarm condition is active)



CAUTION Do not use a long press of the Power button to power down the monitor when it is functioning normally. You will lose patient data and configuration settings. Touch the **Settings** > **Device** tabs to power down the monitor.

The LED in the center of the power plug symbol indicates the battery charging status.

- Green indicates that AC power is present and that the battery is fully charged.
- Amber indicates that AC power is present and that the battery is charging.

Power up the monitor

The monitor runs a brief diagnostic self-test each time it powers up. If an alarm situation occurs, the alert appears in the Status area.



WARNING To ensure patient safety, listen for two audible indicators (a beeper and a speaker tone) and watch for visual alerts at power-up at least once daily. Correct any system errors before using the monitor. In addition to the audible indicators, the screen Status area displays color coding, icons, and messages that help you to distinguish clinical priority and actions, if needed.

Type of alert	Color
High Alarm	Red
Medium Alarm	Flashing amber

Type of alert	Color
Low Alarm	Steady amber
Very Low Alarm	Cyan
Information message	Blue



WARNING Steady amber indicates a low-level alarm. Flashing amber indicates a medium-level alarm. Flashing red indicates a high-level alarm.



WARNING Always observe the monitor during power-up. If any display fails to illuminate properly, or if a system fault code or message displays, inform qualified service personnel immediately, or call your nearest Welch Allyn Customer Service or Technical Support facility. Do not use the monitor until the problem is corrected.



CAUTION Always use the monitor with an adequately charged and properly functioning battery.



CAUTION During intervals monitoring, keep the monitor connected to AC power at all times.



CAUTION Use only a Class I (grounded) AC power cord to charge the battery for this monitor.

Press  to power up the monitor.

When the device is powering up, the LED flashes until the monitor displays the Welch Allyn logo and a power-up tone sounds.

A pop-up screen appears, depending on your configuration and functionality.

- On initial power-up, the monitor prompts you to set the language, date, and time. See “Change the language” and “Set the date and time” for directions.
- If your facility has chosen a login format, then the first image you see is the login screen.
- If your facility has not chosen a login format, then the first image you see is the Home tab.
- If *Bluetooth*[®] is enabled, a list of paired devices and the option to add a new device is available.

***Bluetooth*[®] wireless technology**

Bluetooth wireless technology is available in the Office profile.

***Bluetooth* status**

A monitor with *Bluetooth* wireless technology displays the status between the monitor and the laptop in the Status area.

Image	Description
No image	<i>Bluetooth</i> radio is OFF

Image	Description
<i>Bluetooth</i> icon appears in Status area	<i>Bluetooth</i> radio is ON
<i>Bluetooth</i> icon is blinking on / off slowly	The monitor is pairing with the laptop
<i>Bluetooth</i> icon is blinking on / off quickly	The monitor is connecting with the laptop
<i>Bluetooth</i> icon appears with a border around the icon in the Status area	The monitor and the laptop are connected and the monitor is ready to transmit data

In order to transmit data, you must first pair and then connect the monitor and the laptop.

Pair devices with *Bluetooth* wireless technology

When a monitor with *Bluetooth* wireless technology powers on and there are laptops already paired with the monitor, a pop-up screen appears showing the laptops available for connection with the monitor. Follow the directions below to pair an additional device with the monitor.



1. Touch .
2. Touch **Add new device**.
3. In your *Bluetooth* program manager on your laptop task bar, select the monitor from the list of available devices.

A message appears indicating that the monitor has been discovered and displays a confirmation number on both the laptop and monitor screens.

4. Confirm that the numbers match on the laptop and on the monitor, and then touch **Accept**.

A message appears indicating that the monitor and laptop are paired.

5. Touch **OK**.

A screen appears that allows you to change the laptop name to a preferred name.

6. Enter the preferred name, and then touch **Save**.

The new name appears in the list of paired devices.

Connect devices with *Bluetooth* wireless technology and download data

1. In the *Bluetooth* connection screen, select a laptop from the list of paired devices.

The *Bluetooth* icon in the Device Status area quickly blinks on and off as the monitor and laptop are connecting.

When the monitor and the laptop connect, an information message briefly appears that names the connected laptop. When the message disappears, the name of the connected laptop appears on the top left of the screen, and the *Bluetooth* connected icon appears in the connection area.

2. As the laptop downloads data, the progress indicator spins in the connection area.

The *Bluetooth* connection remains active until the download is complete. After a successful download, the system clears data from the monitor and disconnects the monitor from the laptop.

3. Repeat the process as needed, or touch **Cancel** to dismiss the *Bluetooth* connection screen.

Rename a laptop

You can rename a paired laptop from a system or generic name to a specific name.

1. Select the arrow button to the right of the laptop name you want to edit in the paired list.

A screen appears that allows you to change the laptop name to a preferred name.

2. Enter the name, and then touch **Save**.

The new name appears in the list of paired devices.

Set the date and time

Depending on your facility's configuration, the date and time may already be set. If the time is set in the network configuration, the network time overrides any manual time that is set.

1. Touch the **Settings** tab.
2. Touch the **Date / Time** vertical tab.
3. Touch either the ▲ or ▼ keys or the the key pad, set the date and time.
4. Touch **Set Time**.

You must touch **Set Time** when setting the date, time, or both the date and time.

Note The date and time stamps on saved patient measurements will adjust when you change the date and time settings.

Change the language

Refer to "Advanced Settings" in the *Service manual* for instructions on how to change the language.

Power down the monitor

If you power down the monitor using the  button, patient measurements are retained in the monitor memory for a maximum of 24 hours. These saved measurements are available for recall or electronic transmission to the network. This method also ensures that any configuration settings you have changed and saved will be maintained at the next startup.

1. Press .



If there is a software update available, then a system message asks if you want to upgrade the software.

2. If you want to upgrade the software, touch **OK**.
3. If there is no system message, a dialog box appears with options.
 - Sign out (if you signed in with a Clinician ID)
 - Power down
 - Sleep
 - Cancel

4. Touch one of the options.

The monitor will either sign you out as a clinician so that another clinician can sign in, power down, go into Sleep mode, or return to the prior screen, depending on the option you choose. The battery continues to charge when in Sleep mode.

Reset the monitor

1. If the monitor stops functioning, press and hold , located on the lower-left corner of the monitor, to reset the monitor.
2. If there is a prompt with options to power down, Sleep, or Cancel, continue to press .

The monitor performs a power reset.



CAUTION Do not use a long press of  to power down the monitor when it is functioning normally. You will lose patient data and configuration settings. See “Power down the monitor” to power down the monitor.

Sleep mode

After a configurable amount of time, the monitor enters sleep mode. Different types of inactivity have different time delays.

- When a configurable amount of time has passed since the last screen press
- The sensor modules are not being used to capture vitals
- If the monitor does not have an active alarm

The monitor does not enter sleep mode when it is in Intervals monitoring.

Three situations cause the monitor to leave sleep mode.

- The power button is pressed.
- The screen is tapped.
- An alarm occurs.

Enter Sleep mode

1. Press .
2. If there is no system message, a dialog box appears with options.
 - Sign out (if you signed in with a Clinician ID)
 - Power down
 - Sleep
 - Cancel

3. Touch **Sleep**.

The monitor enters Sleep mode.

Exit Sleep mode

1. Press either  or tap the screen.
The Login dialog box appears.
2. If you are the current user and are in a facility-specific login format, use the scanner or keypad to enter your ID and password.

If you are logging back into the monitor, the monitor returns to the screen that previously was visible, keeps the patient's context, and maintains the vital signs that could have been previously captured.
3. If you are a new user, use the barcode scanner or keypad to enter your ID and password.

Login methods

You can sign in to the monitor in two ways:

- By signing in on the login screen if your facility has chosen a login format.
- By signing in on the Clinician tab if your facility has not chosen a login format.

Sign in using the login screen

1. Using the keyboard or the barcode scanner, enter your ID and password in the respective fields, and then touch **Sign in**.

The Profile selection area becomes active and contains from one to three profiles.

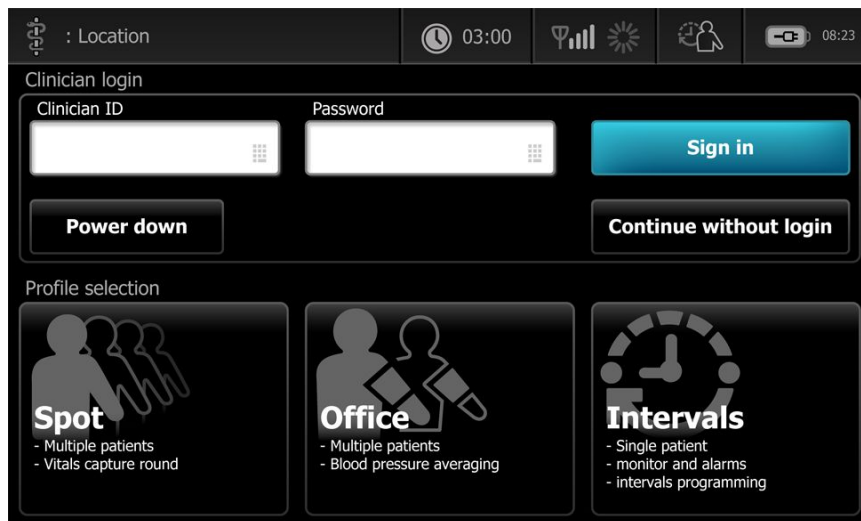

2. From the profiles displayed for your level of permissions, select the desired profile.
The Home tab for the chosen profile appears.

Sign in using the Clinician tab

1. Touch the **Settings** > **Clinician** tabs.
2. Using the keyboard or the barcode scanner, enter your ID and password in the respective fields, and then touch **Sign in**.

The Clinician ID appears in the Clinician ID field on this tab and in the Status area on the Home tab.

Use a barcode scanner

The monitor enables the scanning of patient and clinician barcodes to enter ID information. The barcode scanner (scanner) supports linear and two-dimensional barcodes.

If you have not done so previously, use the instructions provided with the scanner to attach the scanner to the monitor.

Note Refer to the manufacturer's instructions to ensure that the scanner is set to USB Com Emulation mode. Confirm the type of EMR version being used by your facility.

1. Remove the scanner from its holder.
2. Hold the scanner approximately 6 inches (15.4 cm) from the barcode and squeeze the scanner trigger so that the light from the scanner appears on the barcode.

Once the scanner completes a successful barcode reading, the ID appears in the targeted area (Patient frame, data field, or Device Status area). See the additional notes below.

If the scanner has difficulty reading the barcode, slowly adjust the distance and the angle between the scanner and the barcode while squeezing the scanner trigger. If it continues to have difficulty, verify that the barcode is as flat as possible.

Note You can scan a patient's barcode from the Home tab. The scanned ID appears in the Patient frame on the Home tab.

Note Scanning a clinician ID while the Clinician ID pane is open places the scanned ID into the Clinician ID section of the Device Status area. Touch **OK** to return to the Home tab and to begin obtaining patient measurements.

Profiles

The monitor offers multiple profiles, including Spot, Office, and Intervals.

Spot profile

The Spot profile is optimized for rapid multi-patient vitals capture with custom and additional parameters, facility-specific login format, vital sign capture, and multiple patient review.

The Spot profile Home tab displays the following parameters and features:

- NIBP
- Pulse rate
- Respiration rate
- Temperature
- SpO2
- Custom scores
- Additional parameters

- WiFi and ethernet capability

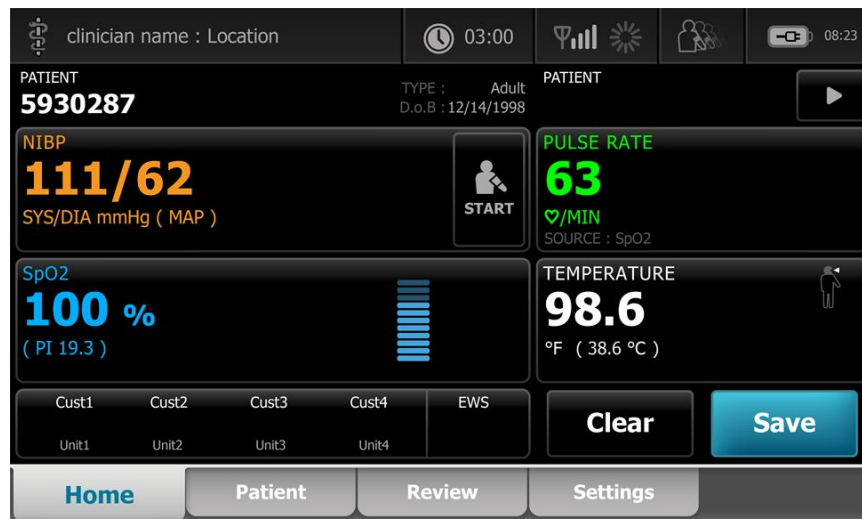

Office profile

The Office profile is optimized for ambulatory vitals capture with external patient context and optional *Bluetooth*® functionality.

The Office profile Home tab displays the following parameters and features:

- NIBP
- Pulse rate
- Respiration rate
- Temperature
- SpO2
- BMI
- Height, weight, pain
- USB and *Bluetooth*® capability

Configurable parameters can be accessed in the Office profile on the Home tab by touching **Height/Weight/Pain/RR**.



Intervals profile

The Intervals profile is optimized for unattended episodic interval monitoring of a single patient with single patient review and alarms.

The Intervals profile Home tab displays the following parameters and features:

- NIBP
- Pulse rate
- Respiration rate
- Temperature
- SpO2
- Alarms
- Custom scores
- Additional parameters
- WiFi and ethernet capability

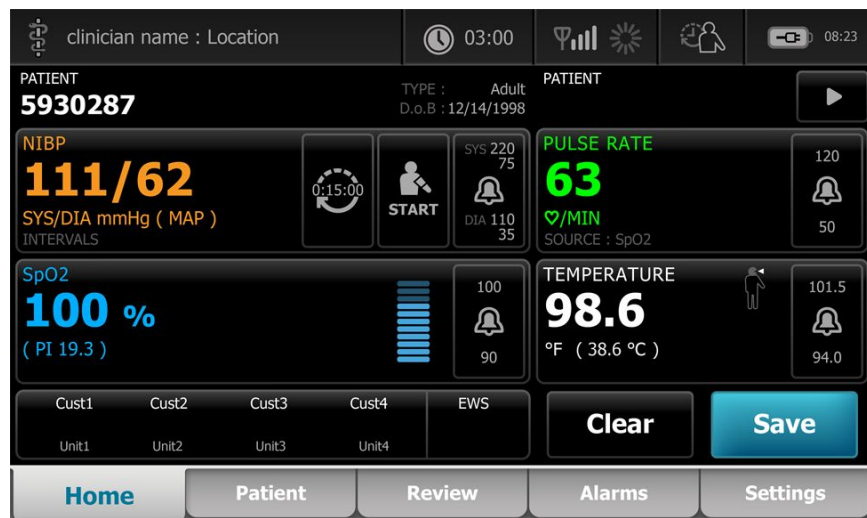

Profile feature comparison

The monitor offers multiple profiles, including Spot, Office, and Interval.

Profile feature comparison

The following table compares the features of the profiles.

Feature	Spot	Office	Intervals
Configure and use interval timing setting			X
Observe and configure alarm limits			X
Observe and respond to physiological alarms			X
Access Alarms tab			X
Take NIBP, SpO2, temperature, and pulse rate readings	X	X	X
Change patient type (adult, pediatric, neonate)	X	X	X
View and enter manual temperatures (height, weight, pain, respiration, temperature and BMI) ¹	X	X	X
Save currently displayed data to device memory	X	X	X
Save patient data	X	X	X
Review patient data	X	X	X
Access Patients tab	X	X	X
Access Review tab	X	X	X
Access Settings tab	X	X	X

¹Braun IR thermometers configured to work with the monitor transfer temperature data automatically to the temperature frame. You can enter the temperature manually if you take a patient temperature with a thermometer that is not connected to the monitor, and you have selected temperature as one of the four manual parameters to display.

Select a profile from the log in area

If your facility has configured the Connex Spot Monitors with a facility-specific format, the Log in screen appears when the monitor is powered up

1. Sign in to the monitor.

The Profile selection screen appears and displays up to three profiles.

2. Touch the desired profile.

The Home tab appears for the chosen profile.

If you change the profile while acquiring patient measurements or while unsaved patient measurements are displayed, the measurements are deleted.

Change a profile

1. Touch the **Settings** tab.
2. Touch the **Profiles** vertical tab.
3. Touch the desired profile.

The corresponding Home tab appears.

Profiles cannot be changed while acquiring patient measurements or while unsaved patient measurements are on the screen.

Common screen functionality

Many parameter areas on the screen allow you to enter data. Touch an icon to perform the function noted.

Icon



Description

Numeric keypad for entering numeric information.





Alphanumeric keyboard for entering both alpha and numeric information.

Shift key enters the next letter touched as uppercase.

Data field in which data is entered.

Back key to delete data starting at the right side of the data being entered.

Next key captures the data entered, clears the data field, and advances to the next data field for data entry.

Icon	Description
	OK key captures entered data and closes keypad or keyboard being used to enter data.
	Cancel key closes the keypad or keyboard without capturing entered data.
	Alpha key in the upper-left corner returns the keyboard to the basic alpha layout.
	Symbol key in the upper-left corner changes the keyboard from the basic alpha layout to the symbols and special characters layout.
	Diacritical marks key in the upper-left corner changes the keyboard from the basic alpha layout and displays diacritical marks for the selected language.

Primary screens

The monitor has primary screens and pop-up screens.

The primary screens have three sections:

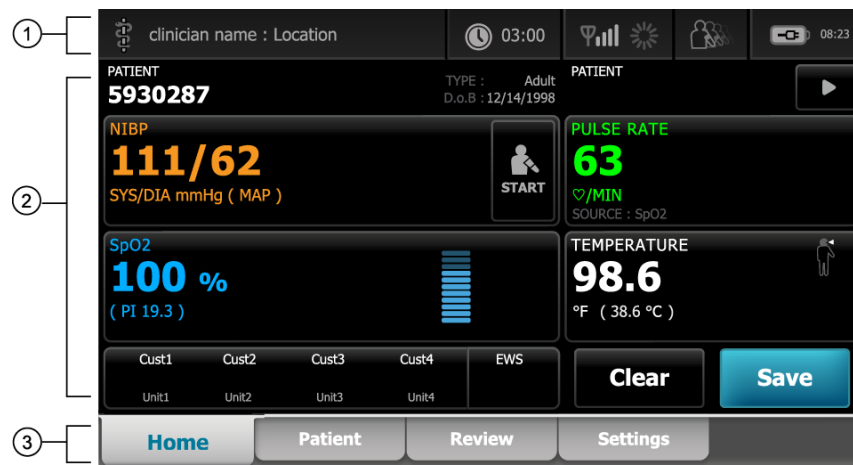

Item	Description
1 Status	Status area appears at the top of the screen and includes information regarding system-wide features.
2 Content	The Content area displays information determined by the primary — or global — navigation tab chosen at the bottom of the screen. The content area also might have vertical tabs on the left side of the screen that relate to the primary navigation tab chosen. It also can display summary information on current vital signs.

Item	Description
3	Primary navigation
	Based on which profile is in use, the primary navigation tabs for that profile appear at the bottom of the screen.

Battery status

The battery status indicator displays the state of the battery.

The battery status is represented by icons in the upper-right corner of the monitor display. The status represents several possible situations.

- The monitor is connected to a power source and the battery is charging or is fully charged. The estimated charge rate is displayed as a percentage of capacity.
- The monitor is not connected to a power source and is running on battery power. The estimated charge time remaining, representing all available batteries in the monitor and stand, is shown by a series of 1–4 bars and hours/minutes:
- The monitor is connected to a power source but the battery does not maintain a charge (or has been removed).

Bars	Description
4	Running on battery, battery charge is high; 76% - 100%; display time remaining (HH:MM)
3	Running on battery, battery charge is medium; 51% - 75%; display time remaining (HH:MM)
2	Running on battery, battery charge is low; 26% - 50%; display time remaining (HH:MM)
1	Running on battery, battery charge is very low; 11% - 25%; display time remaining (HH:MM)

When the battery is not being recharged and power becomes low, an amber, low-priority alarm appears in the Status area.

Note Monitor the remaining battery charge in the battery status indicator and plug the monitor into a power outlet as soon as you are able.

If the low-priority alarm is dismissed or if you take no action to charge the battery, a red, high-priority alarm appears and sounds when battery power is critically low. Plug the monitor into a power outlet immediately to prevent the monitor from powering down.

Alarm and information messages

The Device Status area provides alarm and information messages that are either temporary or exist as long as the condition to which the message applies remains. Alarm or information messages may also include controls or behavior that you can use to manage alarm and information messages.

When the monitor detects an alarm condition, the vitals frame relating to the alarm flashes and an alarm message appears. When multiple alarms occur, the highest priority message appears first. You can cycle through each alarm message by touching the multiple alarm toggle.

Information messages instruct you to interact with the monitor in a specific way or provide information that does not require action. You can dismiss an information message by selecting the control associated with the message or waiting for the message to time out.

Screen lock mode

The screen lock blocks the display of patient information and prevents any input, which may be useful when cleaning the display.

The screen locks when any of the following occur:

- You touch **Display lock**.
- There is no interaction with the monitor for the period specified in the Settings tab. An authorized person can access the Advanced Settings tab to set or change the time specified for the screen lock to be triggered.

Lock the screen

Follow these steps to touch the screen without activating the controls.

1. Touch the battery icon in the Status area or touch the **Settings** tab.
2. Touch the **Device** vertical tab.
3. Touch **Display lock**.

The screen can also be configured to automatically lock after a pre-determined time of inactivity. See "Configuration Settings" for further directions.

Unlock the screen

If a Clinician ID login format has been configured for your site, follow the steps below. Otherwise, simply touch the lock icon to unlock the screen.

1. Using the barcode scanner or keypad, enter your ID or scan your ID and password.
2. Follow the onscreen prompts to unlock the screen.

A user logs on to the device, by either scanning or manually entering their ID and password. When a new user attempts to log onto the device, a dialog box appears: "Would you like to log the current user, XXX, out?"

If the new user selects **No**, then the initial user remains logged on. The new user can use the device, but the initial user is shown as logged on. If the new user selects **OK**, then the initial user is logged out, and the new user is logged on and taken to the Home screen.

Manual entry and parameter modifiers

You can change parameters manually by toggling between parameter values or using a pop-up screen to enter specific values.

Change a parameter unit

The units of measure for NIBP can be manually changed on the Home tab.

Touch the NIBP frame.

The NIBP changes between SYS/DIA and MAP.

Note An authorized person can change the temperature unit of measure in Advanced settings.

Change a frame manually

1. Press and hold a frame, such as **NIBP**.

A pop-up dialog box appears.

2. Manually enter the value.
3. Touch **OK**.

The manual value appears in the frame on the screen.

Pop-up screens

When a pop-up screen appears, you cannot access any buttons or controls on the screen behind the pop-up. The specified action on the pop-up screen must be accomplished or, if allowed, actively dismissed or canceled, before other screens become active.

There are instances when multiple, layered pop-up screens occur. In these instances, only the top pop-up screen is accessible. The specified action on the top pop-up screen must be accomplished or, if allowed, actively dismissed or canceled, before the pop-up screen behind becomes active.

Navigation

There are four types of navigation in the monitor:

- Primary tabs
- Vertical tabs
- Command buttons
- Shortcuts

Primary tabs

The primary tabs at the bottom of the screen enable you to switch between tabs and change the controls in the content area on the monitor. The profile you choose determines which tabs are available. The tab you choose determines what information appears on the screen. The five primary tabs are

- Home

- Patient
- Alarms
- Review
- Settings

Vertical tabs

The vertical tabs on the left side of the screen enable you to navigate to additional areas of a primary tab. The vertical tabs displayed are determined by the primary tab chosen.

Command buttons

Command buttons, such as the Start Intervals button, enable you to navigate and perform actions.

Shortcuts

Shortcuts provide an efficient means of navigation. For example, touching the battery area in the status bar enables you to navigate to Settings [**Settings > Device > Date/Time**] and displays more information about that portion of the monitor.

Home tab

The Home tab displays patient information.

- Status area, including alarm status and battery status
- Patient area, including name and ID
- NIBP
- SpO2
- Pulse rate
- Temperature
- Action area, including Clear and Save

Patient tab

The Patient tab contains the Patient Summary screen.

- Patient name
- Patient location
- Patient ID
- Patient type
- Action area, including OK and Cancel.

Alarms tab

The Alarms tab contains vertical tabs.

- General
- NIBP
- Pulse rate
- SpO2
- Temperature.

The General tab contains parameter controls for alarm limits, volume controls, audio controls, and alarm reset.

Review tab

The Review tab displays patient data that has been previously captured. Data can be viewed for a single patient or for multiple patients. The Review tab displays both core and custom parameters and also provides controls.

- Patient name
- Date / Time
- Core vital signs
- Custom parameters
- Controls, including View, Send and Delete

Settings tab

The Settings tab enables you to edit certain device functions. It contains vertical navigation tabs.

- Intervals
- Profiles
- Device
- Date / Time
- Clinician
- Advanced (this vertical tab is password protected and available only to authorized personnel)

Adjust screen brightness

The screen can be adjusted to 10 levels of brightness. Adjust screen brightness in the Device tab in Settings.

1. On the Settings tab, touch **Device**.
2. In the Brightness area, touch ▲ or ▼ to brighten or dim the screen.

Patient data management

Patient data is managed through the Patient tab.

From the Patient tab, you can do the following:

- Scan a patient ID with the barcode scanner and return an Admit/Discharge/Transfer (ADT) patient name match.
- Enter additional patient information.



WARNING Patient injury risk. To ensure data integrity and patient confidentiality, save readings and clear the monitor's display between patients.



WARNING Verify patient identity on the monitor after manual or barcode entry and before saving or transferring patient records. Failure to identify the correct patient can result in patient injury.

Load patient data with the barcode scanner

You can use a barcode scanner to query existing patient records and perform an ADT patient name match.

Note If the monitor is connected to the network, the monitor can receive a patient name from patient records associated with a scanned ID number.



WARNING Patient injury risk. Verify patient identity on the monitor after manual or barcode entry and before printing or transferring patient records. Failure to identify the correct patient can result in patient injury.

1. Confirm that you are on the Home tab.
2. Scan the patient's barcode with the barcode scanner.

The Patient ID appears in the Patient frame.

If a barcode scanner is not available or not functional, manually enter the patient information using the screen keyboard.

Add a patient

Note This option is available in the Spot and Intervals profiles.

1. Touch the **Patient** tab.
2. Touch  in any field and then enter patient information.
3. Touch **Next** to cycle through the patient data fields.

Note You can use a barcode scanner to enter a patient ID in the Patient ID field. Touch  in the Patient ID field, scan the barcode, and touch **OK**.

4. Touch **OK** to save and return to the Home tab.

Manage patient records

Patient records can be sent to the network or deleted.

1. Touch the **Review** tab.

Note Measurements that triggered a physiological alarm are highlighted on this tab.
2. Select patients by touching the check box next to their names.
3. Touch **Send** to transmit the records to the network or **Delete** to permanently remove the records as desired.



CAUTION Verify patient identity on the monitor after manual or barcode entry and before transferring patient records.

Note The  icon indicates the records have been sent to the network.

- Note** You can configure the Intervals profile, to automatically send measurements to the network.
- Note** Patient measurements older than 24 hours are automatically deleted from the patient records list on the Review tab.
- Note** Modifying the date and time on the device modifies the date and time on all saved readings on the device.

Modifiers

The Modifiers tab enables you to enter additional information for current measurements.

Set modifiers

1. Touch the **Patient** tab.
2. Touch the **Modifiers** tab.
3. Adjust the NIBP, SpO2, and temperature settings as required.
4. Touch **OK** to accept the changes and return to the Home tab or touch **Clear** to delete all entries.

The Modifier settings clear after a power cycle, after you clear or save the Home tab, or after you select a new patient.

Alarms

The monitor presents physiological alarms and technical alarms. Physiological alarms occur when vital sign measurements fall outside of set alarm limits, but they occur only in the Intervals profile. Technical alarms occur in all profiles.

If the alarm system is powered down, the alarm log is maintained on the monitor for 14 days.

Note The three modes of data communication—USB, Ethernet, and IEEE 802.11—are not intended for real-time alarms.

Vital sign summary view

At the top of the Alarms tab is a summary view of the core vital signs.

You cannot control any of the core vital sign parameters from the summary view.

Alarm limits

Default alarm limits are determined by the facility and are incorporated in the configuration file. Only authorized facility personnel can edit these limits.

Alarm reminder signal

An alarm reminder signal appears for all alarms if the global alarm audio has been paused or turned off. The reminder signal interval is the same as the alarm interval with which it appears.

Alarm types

Type	Priority	Color	Alarm audio tone
<ul style="list-style-type: none"> NIBP or SpO2 limit exceeded Some technical alarms Pulse rate limit exceeded 	High	Red	10-pulse tone
<ul style="list-style-type: none"> Some technical alarms 	Medium	Amber	3-pulse tone
<ul style="list-style-type: none"> Temperature limit exceeded 	Low	Amber	2-pulse tone or 1-pulse tone

Type	Priority	Color	Alarm audio tone
<ul style="list-style-type: none"> Some technical alarms 			

Alarm notification locations



WARNING Patient injury risk. If you are relying on visual alarm notifications, maintain a clear line of sight with the monitor and/or Nurse Call. Set the volume as needed considering the environment and ambient noise levels.



WARNING Patient injury risk. Do not set the alarm parameters to extreme levels. Setting extreme parameters could render the alarm system useless, causing the potential for patient injury.

Nurse Call

When the Nurse Call cable is connected and Nurse Call has been enabled, the monitor immediately notifies the Nurse Call system when an alarm occurs. Nurse Call notification settings are specified in the configuration settings.

Home tab

Home tab notifications

Notification	Description
Device Status area	The area changes color and displays a message with an accompanying status icon or button. If the alarm tone is in a pause interval, a timer countdown appears. If multiple alarms and information messages are active, the Device Status area shows the highest priority alarm. If the alarms are equal in priority, the most recent alarm message appears. You can cycle through the messages for each active alarm.
Parameter frame	The frame of the parameter brick flashes in the color of the alarm priority. Touch this area to pause or turn off an alarm audio tone. Visual indicators and Nurse Call notification will persist during an audio paused condition.
Alarm Limit control	The icon in this control indicates the status of the alarm limit settings. Red and amber icons indicate measurements that have exceeded alarm limits. Touch this control to navigate to a parameter-specific tab where you can modify alarm limit settings.





Icons on the Home tab

Icons on the Home tab

Icons in parameter frames

The icons in the parameter frames indicate alarm notification settings. When alarm limits are on, the icons will be gray until an alarm occurs. Then, the icons will change color to indicate the priority of the alarm. Red icons represent high priority alarms, and amber icons represent medium or low priority alarms.





Icons in parameter frames

Icon	Name and status
	Alarm off. No visual or audio alarms or Nurse Call notification will occur for this parameter.
	Alarm on. Audio and visual notifications and Nurse Call are enabled.
	Alarm audio off. Only visual notifications, including Nurse Call, will occur.
	Alarm audio paused. The default audio pause alarm duration is 1 minute. The icon remains until the paused time counts down to 0. Authorized personnel can configure this parameter.

Icons in the Device Status area

The icons in the Device Status area are black and white, but the background area changes color to indicate the alarm priority. Messages accompany these icons. These icons can be controls or status indicators.

Icons in the Device Status area





Icon	Name and status
	Alarm active. One or more alarms are active. Touch this icon to pause or turn off the audio tone.
	Alarm audio off. Audio signals are disabled, but alarm limits and visual alarm signals remain active.
	Multiple alarms toggle. Touch this icon to cycle through the messages for each active alarm.
	Alarm audio paused. The audio tone is paused for a period ranging from 90 seconds to 15 minutes. The icon remains until the paused time counts down to 0. Touch this icon to reset the pause interval. The pause interval is determined by settings in the Advanced tab.

Reset (pause or turn off) audio alarms

Audio alarm characteristics

- After you reset an audio alarm, some tones do not return, but others return after a pause interval if the condition that caused the alarm persists. Settings in the Advanced tab determine the length of the pause interval.
- If a new alarm condition occurs during a pause interval, a new audio tone occurs.

Pause or turn off an audio alarm

1. In the Device Status area, touch .
 - Visual indications remain in the parameter frame until the condition is corrected or until the next measurement is taken.
 - In the Device Status area, if the icon changes to  and the message remains, the timer counts down and the audio tone returns after a pause interval. You can touch  again to restart the timer. If you responded to an NIBP alarm and multiple NIBP limits have been exceeded, the first audio tone and message go away, but another NIBP limit message shows with a countdown timer. A new NIBP audio tone sounds after the countdown unless you touch  to dismiss each remaining NIBP limit message.
2. If multiple alarms are active, a multiple alarm toggle will appear in the Device Status area. Respond to multiple alarms as follows:

- a. Touch  in the Device Status area. (See note below.)
- b. Read the alarm message for the second alarm.

- c. Touch .
- d. Continue to touch multiple alarm toggle buttons and to reset tones until you have read all of the messages.

Note The multiple alarm toggle button will display the number of active alarms inside the alarm icon. A set of dots indicating the display order of alarms from highest (left) to lowest (right) priority (as well as the most recent in the case of multiple alarms of the same priority) will appear below it.

Adjust vital sign alarm limits

You can adjust vital sign alarm limits or turn off alarm limit checking for individual parameters.



WARNING Alarm limits are user adjustable. All alarm limit settings should take into account the patient's condition and acute care needs. Appropriate alarm limits should be set accordingly for each patient.



CAUTION Loss of power will cause the monitor to return to default settings. Each time you power up the monitor, you must set alarm limits appropriate for your patient.

1. On the Home tab, touch the alarm limits control in the selected parameter frame. For





example, to adjust the NIBP alarm limits, touch

2. Adjust vital sign alarm limits.

- To adjust a limit: Touch ▲ or ▼ or touch the keypad to set the desired upper and lower alarm limits.



- To turn alarm limits off or on for the vital sign: Touch  ON OFF or  ON OFF. This button toggles to display the current alarm state. If you turn off alarm limit checking for a vital sign, no visual or audio alarm signals will occur for those limits. If alarm limit checking is off, the icon changes to



on the Home tab in the parameter frame.

Modify audio alarm notification

You can modify the volume of all audio alarms.

Note If the **Allow user to turn off general audio** option has been selected in Advanced settings, you can turn off audio alarms, but turning off alarms is not recommended in some circumstances, such as unattended monitoring.



WARNING The alarm volume should be loud enough for you to hear it from where you are. Set the volume considering the environment and ambient noise levels.

As you set parameters on the Alarms tab, measurements appear across the top of the tab.

1. Touch the **Alarms** tab.
2. On the **General** tab, modify audio alarm notifications.
 - To display alarm limits, in the Limits panel, select the **Display alarm limits** checkbox.
 - To turn audio alarms on or off, select the **Alarm audio on** or **Alarm audio off** button.

If you turn off audio alarms, visual alarm signals still occur in the Device Status area and on the Home tab in parameter frames.



The  in the Device Status area indicates alarm audio turned off, and a

similar bell will appear in the parameter frames . If an alarm condition occurs, the bell will be red or amber in the alarming frame, according to the

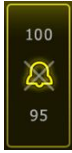
priority of the alarm, as shown here:  or .

- To modify the volume of audio alarms: Select the volume button next to either **High**, **Medium**, or **Low**. An audio tone sounds briefly to indicate the volume level.

Note Periodically test the speaker by selecting different speaker volumes and listening for the different tones.

- To reset alarm settings to the original configuration, touch **Alarm reset**.

Alarm messages and priorities

The following table lists the physiological alarm messages and their priorities.

See “Troubleshooting” for technical alarm messages.

Physiological alarms

Alarm messages	Priority
Alarm limit exceeded. NIBP systolic HIGH.	High
Alarm limit exceeded. NIBP systolic LOW.	High
Alarm limit exceeded. NIBP diastolic HIGH.	High
Alarm limit exceeded. NIBP diastolic LOW.	High
Alarm limit exceeded. NIBP MAP HIGH.	High
Alarm limit exceeded. NIBP MAP LOW.	High
Alarm limit exceeded. Pulse rate HIGH.	High
Alarm limit exceeded. Pulse rate LOW.	High
Alarm limit exceeded. SpO2 HIGH.	High

Alarm messages	Priority
Alarm limit exceeded. SpO2 LOW.	High
Alarm limit exceeded. Temperature HIGH.	High
Alarm limit exceeded. Temperature LOW.	High

Nurse Call

The monitor can be connected to a Nurse Call system through a cable that connects to the Nurse Call connector.

When the Nurse Call cable is connected and Nurse Call is enabled, the monitor immediately notifies the Nurse Call system when any alarm condition occurs that exceeds the preset threshold. The Nurse Call system is also synchronized with the alarm frame and audible alerts on the monitor.

Nurse Call thresholds are set in the configuration settings.

To connect the monitor to a Nurse Call system, you must have a cable that has been adapted to your Nurse Call system (REF 6000-NC), rated 25V AC or 60V DC maximum at 1A maximum. For ordering information, see *Approved Accessories* in the Appendix.



WARNING Do not rely exclusively on Nurse Call for patient monitoring. Although the Nurse Call option enables remote notification of an alarm condition, it is not intended to replace appropriate bedside patient monitoring by trained clinicians.

Note

When a patient alarm occurs, touching the alarm icon in the Device Status area pauses the alarm tone for 1 minute, as specified in the default settings in Advanced Settings, but the visual alarm indicator(s) on the monitor and Nurse Call continue.

Patient monitoring

Required parameters

If a parameter is required, a Skip button appears at the bottom of the parameters, and a Next button appears in the lower-right corner of the screen. Parameters may require three types of inputs.

- Numerics
- Drop-down lists
- Parameter option buttons

If you choose not to record information for the parameter, a dialog box appears to confirm that the parameter is not being recorded.

If you have a required modifier, such as height, weight, or pain, it will take priority over other defined modifiers.

Once all parameters have been completed or skipped all required parameters, optional parameters may appear. Once these have been completed or skipped, touching the Next button returns you to the Home tab.



WARNING Many environmental variables, including patient physiology and clinical application, can affect the accuracy and performance of the monitor. You must verify all vital signs information before treating the patient. If there is any question about the accuracy of a measurement, verify the measurement using another clinically accepted method.



WARNING Patient injury risk. During defibrillation, keep discharge paddles away from monitor sensors, and other conductive parts in contact with the patient.

Complete required parameters

Required parameters appear before optional parameters.

1. From the Home tab, touch **Next**.

A pop-up screen appears with three parameters. The Next button is inactive and the **Cancel** button is active.

2. Touch the first parameter and either manually enter the required information or enter the data with the format presented.

The data is captured.

3. Proceed to the second and third parameters and enter the required information either manually or enter the data with the format presented.
4. If there is a required parameter that you choose not to complete, then touch **Skip**.
An override dialog box appears explaining that it is a required parameter and the EMR will note that it was not captured.
5. Touch **Cancel**, return and complete the parameter, or touch **OK** to continue to the next parameter.
6. Once all parameters on the screen are completed or skipped, touch **Next** to proceed to the next screen.
There may be several screens with required parameters.
7. Once all required parameters have been completed or skipped, optional parameters may appear. Since optional parameters are not required, the Next button is active on each screen with optional parameters. Complete the optional parameters as appropriate for your patient.
8. When you are finished, touch Next.
A screen appears that gives you the option of sending data to a laptop, if it is *Bluetooth*[®] enabled, or saving the data to the monitor.
9. Touch **Save** to save the data to the monitor. If you are connected to a laptop, the data is downloaded automatically.

Intervals

The monitor can capture NIBP and SpO2 measurements automatically, based on intervals you choose on the Settings tab.

In Settings, the Intervals tab provides all intervals features. You can access this tab from the Office and Intervals profiles.

In the Intervals profile, you can set three types of intervals:

- Automatic
- Program
- Stat

In the Office profile, you can set Averaging intervals.

You can do the following from the Intervals tab.

- Configure intervals
- Turn off intervals

When the measurement is complete, the frame for that parameter displays the measurement until the next measurement is complete.

Note During intervals, each automatic and manual save of patient measurements clears all measurements from the Manual parameters frame.

The Intervals button changes to a timer, which counts down to the next automatic measurement.

Automatic measurements continue until you turn off intervals.



WARNING Patient harm risk. Do not use intervals on neonates out of your hearing range. Verify that the audio can be heard from where you intend to be.

Automatic intervals

You can configure the monitor to take automatic NIBP measurements at consistent intervals.

Note An alarm does not turn off intervals. Subsequent automatic measurements continue to occur as scheduled.

Start Automatic intervals

1. Place the proper cuff around the patient's bare upper arm.
2. On the Home tab, touch .
The vertical Intervals tab on the Settings tab appears.
3. Select **Automatic**.
4. Use the keypad to enter the length of time between NIBP measurements.
5. Touch **Start intervals**.

Program intervals

The monitor comes with six custom programs. One program is always available for you to customize to meet your specific needs. If your facility does not configure all of the remaining five programs, you can customize the remaining programs at any time.

The numbers below the program names indicate the length of time between each interval in the cycle.

Start program intervals

You must be in either the Intervals or Office profile to access intervals.

1. Place the proper cuff around the patient's bare upper arm.
2. On the Home tab, touch .
The vertical Intervals tab on the Settings tab appears.
3. Select **Program**.
The preconfigured Program screen appears with the available programs and the interval between measurements displayed to the right of the program.
4. Touch the program you want to use.
5. If you want to change the interval for the program selected, use the keypad to the right of the program to enter the new interval.
6. Touch **Start intervals**.

Stat intervals

You can configure the monitor to take NIBP measurements continuously.

When you select Stat on the Intervals tab in Settings, the monitor takes repeated NIBP measurements for 5 minutes, starting a new cycle each time the cuff deflates below safe venous return pressure (SVRP) for 2 seconds.



WARNING Patient injury risk. If you use Stat mode repeatedly, periodically observe the patient's limb to ensure that circulation is not impaired and that the cuff remains in place. Prolonged impairment of circulation or improper cuff position can cause bruising.

Current cuff pressures are not dynamically displayed during a Stat reading. The Home tab displays the NIBP reading from the previous cycle until the current cycle finishes.

Note Touch **STOP** to stop intervals. To restart intervals, go back to the Stat intervals screen.

Start Stat intervals

1. Place the proper cuff around the patient's bare upper arm.
2. On the Home tab, touch .
The Intervals screen on the Settings tab appears.
3. Select **Stat**.
4. Touch **Start intervals**.

Averaging intervals

The averaging interval program enables you to record the patient's average NIBP readings over a set period of time.

Start Averaging intervals

You must be in the Office profile to access Averaging intervals.

1. Place the proper cuff around the patient's bare upper arm.
2. On the Home tab, touch .
The vertical Intervals tab on the Settings tab appears.
3. Select **Averaging**.
The Averaging screen appears with the necessary parameters to establish the set intervals for obtaining NIBP averages.
4. Using either the keypad or ▲ or ▼, set the necessary parameters to establish the averaging intervals program desired.
5. Touch **Start intervals**.

NIBP

NIBP measurements



WARNING Patient injury risk. Do not install luer connectors on blood pressure tubing. Using luer connectors in manual or automated blood pressure systems creates the risk of inadvertent connection to intravenous (IV) tubing, which can introduce air into the patient's circulatory system.



WARNING Patient injury risk. Any external compression of the blood pressure hose or cuff may cause patient injury, system errors, or inaccurate measurements.



WARNING NIBP readings may be inaccurate for patients experiencing moderate to severe arrhythmia.



WARNING Inaccurate measurement risk. Pulse rate measurements generated through the blood pressure cuff or through SpO2 are subject to artifact and might not be as accurate as heart rate measurements generated through ECG or through manual palpation.



WARNING Use caution when measuring blood pressure using oscillometric blood pressure devices in severely ill neonates and pre-term infants because these devices tend to measure high in this patient population.



WARNING Patient injury risk. Inaccurate measurement risk. Do not place the cuff where it can disturb proper circulation. Do not place the cuff on any area where circulation is compromised or on any extremity used for intravenous infusions.



WARNING Possible measurement error. Use only Welch Allyn blood pressure cuffs and accessories; substitution may result in measurement error.



WARNING Inaccurate measurement risk. Ensure an airtight seal at all connection points before use. Excessive leaking may affect readings.



WARNING Inaccurate measurement risk. Minimize cuff movement and arm motion during readings. Excessive movement may alter readings.



WARNING Inaccurate measurement risk. Properly position the blood pressure cuff to ensure blood pressure accuracy.



WARNING Inaccurate measurement risk. Only use the cuff when the artery index marker falls within the printed range indicated on the cuff; otherwise, erroneous readings will result.



CAUTION Inaccurate measurement risk. Any external compression of the blood pressure hose or cuff may cause system errors or inaccurate measurements.

Located in the upper-left corner of the Home tab, the NIBP frame contains data and features relevant to noninvasive blood pressure measurement. The frame provides different features, based on the profile you are using.

For information about obtaining blood pressure measurements, refer to *Blood pressure guidelines* at www.welchallyn.com/.

NIBP measurement display

In all profiles, the frame can display systolic and diastolic measurements, and MAP calculations. Authorized personnel can configure the default view in Advanced settings. The last NIBP measurement remains on the screen unless you touch Save or Clear, or until a new measurement is taken.

If any NIBP measurement is out of range or cannot be determined, the NIBP frame shows a “++” or “--” in front of the measurement. All other NIBP parameters display no values.

View indicator

Touch the NIBP frame to toggle between views.

Buttons

Use the buttons on the right side of the frame to perform different tasks, depending on the profile you are using. The availability of functions depends on which profile you select. See the Profiles section for more information.

Technical alarms and NIBP measurements

A technical alarm stops any NIBP measurement. Once the alarm is resolved, the start button appears and you can start a new NIBP measurement.

NIBP cuffs



Warning Patient injury risk. Use only blood pressure cuffs and hoses listed as approved accessories to ensure safe and accurate NIBP measurements.



Warning Patient injury risk. Never use an adult or pediatric monitor setting or cuff for an NIBP measurement on a neonatal patient. Adult and pediatric inflation limits can be excessive for neonatal patients, even if a neonatal cuff is used.



Warning Patient injury risk. The decision to use the device on pregnant or pre-eclamptic patients is at the discretion of the trained clinician using the equipment.



CAUTION Correct sizing of the blood pressure cuff is important for accurate blood pressure readings. A cuff that is too small might provide false high readings, while a cuff that is too large might provide false low readings.

The monitor uses the oscillometric method to determine blood pressure; therefore, if the cuff extends to the antecubital fossa (bend in the elbow), you can still acquire an accurate blood pressure reading.

If you use a single tube NIBP cuff, you can take only a step blood pressure measurement. The monitor will automatically default to Step BP.

Obtain a single NIBP measurement

1. Touch **START** to begin a single measurement.
The START button becomes an orange STOP button. NIBP always displays the current inflation rate. When complete, the NIBP parameter displays the completed NIBP measurement.
2. Touch **Save** to save the displayed measurement in the patient's record
The measurement will continue to be displayed until you save it or you start another NIBP measurement.

Interval NIBP measurement

You must be in either the Intervals or Office profile to set intervals. Refer to the "Intervals" section for directions on setting intervals.

While you are in the Intervals profile, touch **Start** on the Home tab to acquire a spot NIBP measurement.

The default interval for NIBP measurements is 15 minutes. You can adjust this interval as needed.

Stop automatic measurements

You must be in either the Intervals or Office profile to access intervals.

1. On the Home tab, touch .
2. Touch **Stop intervals**.

Cancel a NIBP measurement

In the NIBP parameter, touch **STOP**.

The monitor cancels the NIBP measurement and an information message appears informing you that the NIBP reading was stopped and that no reading was captured.

If intervals are turned on, the timer icon counts down to the next automatic measurement.

Configure NIBP alarms

1. Verify that you are using the Intervals profile, which contains the Alarms tab.
2. Touch the **Alarms** tab.
3. Touch the **NIBP** vertical tab.
4. Using either the keypad or ▲ or ▼, enter the desired upper and lower alarm limits for systolic and diastolic measurements, and MAP calculation.
5. Touch the **Home** tab.

The new alarm settings display in the Alarm Limit control button.

Temperature

Configure temperature alarms

You must be in the Intervals profile to set alarm limits.

1. Touch the **Alarms** tab.
2. Touch the **Temperature** vertical tab.
3. Using either the keypad or ▲ or ▼, enter the desired upper and lower alarm limits.
4. Touch the **Home** tab.

The new alarm settings appear in the Alarm Limit control button.

General temperature warnings and cautions



WARNING Patient injury risk: The decision to use this device with children, or pregnant or nursing women is at the discretion of the trained clinician using the equipment.



WARNING Inaccurate measurement risk. To ensure optimal accuracy, always confirm that the correct mode and site are selected.



WARNING Patient injury risk. Do not exceed the recommended temperature measurement durations in Direct mode. Continuous measurement durations of 3 minutes at the oral and rectal sites and 5 minutes at the axillary site are recommended for accurate measurement. Do not continuously measure beyond 10 minutes in any mode.



WARNING Patient injury risk. Always take a temperature measurement with a single-use probe cover securely attached. Failure to use a probe cover can cause patient cross-contamination and inaccurate temperature readings.



WARNING Patient injury risk. Always remain with patient while measuring temperature.



WARNING Patient injury risk. Inaccurate measurement risk. Do not use the thermometer if you notice any signs of damage to the probe or the instrument. If the thermometer probe is dropped or damaged, remove it from service and have it inspected by a qualified service person.

Temperature frame

From the temperature frame you can measure patient temperature.





Located in the lower right corner of the Home tab, the temperature frame contains data and features relevant to temperature measurement. The frame provides different features based on the profile you are using.

Temperature measurement display

In all profiles, the frame displays the temperature in Celsius and Fahrenheit. You can configure the default view in Advanced settings.

Site selection



Remove the temperature probe and touch the **Temperature site control** to toggle between sites.

Icon	Description
	Pediatric axillary
	Adult axillary
	Oral
	Rectal. Monitors configured with the temperature module and the red rectal probe well and probe default to the rectal mode.
	Ear mode. The monitor displays the ear mode when it receives a temperature measurement from the ear thermometer.

If a rectal probe is used, The rectal icon appears in the temperature brick and the Site Selection feature is not available.

Temperature buttons

The buttons on the right side of the frame enable you to perform different tasks, depending on the profile you are using. The profile you choose determines which functions are available.

Icon	Button name	Description
	Temperature alarm	Displays alarm limits and status. Touch the button to display the Alarms tab.
	Direct mode	Touch the button to enter Direct mode.

SureTemp® Plus temperature module

The temperature module uses a thermistor thermometer design and a predictive algorithm to calculate patient temperatures in the Predictive mode.



WARNING Patient injury risk. Do not exceed the recommended temperature measurement durations in Direct mode. Continuous measurement durations of 3 minutes at the oral and rectal sites and 5 minutes at the axillary site are recommended for accurate measurement. Do not continuously measure beyond 10 minutes in any mode.



WARNING Patient injury risk. Inaccurate measurement risk. Oral/axillary probes (blue ejection button at top of probe) and blue removable probe wells are used for taking oral and axillary temperatures only. Rectal probes (red ejection button) and red removable probe wells are used for taking rectal temperatures only. Use of the incorrect removable probe well could result in patient cross-contamination. Use of the probe at the wrong site will result in temperature errors.



WARNING Patient injury risk. When taking rectal temperatures, insert the probe tip a maximum of 5/8 inch (approximately 1.5 cm) inside the rectum of adults and a maximum of 3/8 inch (approximately 1 cm) inside the rectum of children to avoid the risk of bowel perforation.



WARNING Inaccurate measurement risk. Always take an axillary temperature with direct contact between the probe cover and the skin. Carefully place the probe in the axilla, avoiding contact with other objects or material.



WARNING Patient injury risk. Always take a temperature measurement with a Welch Allyn single-use probe cover securely attached. Failure to use a probe cover can cause patient discomfort from a heated probe, patient cross-contamination, and inaccurate temperature readings.



WARNING Inaccurate measurement risk. To ensure optimal accuracy, always confirm that the correct mode and site are selected.



WARNING Never use a damaged temperature probe. The thermometer consists of high-quality precision parts and should be protected from severe impact or shock. Do not use the thermometer if you notice any signs of damage to the probe or monitor. If the thermometer probe is dropped or damaged, remove it from use and have it inspected by qualified service personnel.



WARNING Inaccurate measurement risk. For rectal measurements, apply a thin layer of lubricant to probe cover, if necessary, for patient comfort. Use of excessive lubricant may affect reading accuracy.



CAUTION Inaccurate measurement risk. Patient activities such as strenuous exercise, ingesting hot or cold liquids, eating, chewing gum or mints, brushing teeth, or smoking may affect oral temperature measurements for up to 20 minutes.



CAUTION Inaccurate measurement risk. Always use new probe covers taken from the monitor's probe cover box holder to ensure accurate temperature measurements. Probe covers taken from other places or that haven't stabilized in temperature may result in inaccurate temperature measurements.



CAUTION Probe covers are disposable, nonsterilized, and single-use. Probes are also nonsterilized. Do not autoclave probes and probe covers. Ensure that probe covers are disposed of according to facility requirements or local regulations.

Temperature mode selection

The monitor with the temperature module takes a patient temperature in either Predictive (Normal) or Direct mode. The default setting is the Predictive mode.

Predictive mode



WARNING Inaccurate measurement risk. To ensure optimal accuracy, always confirm that the correct mode and site are selected.



WARNING Patient injury risk. Do not exceed the recommended temperature measurement durations in Direct mode. Continuous measurement durations of 3 minutes at the oral and rectal sites and 5 minutes at the axillary site are recommended for accurate measurement. Do not continuously measure beyond 10 minutes in any mode.

Predictive mode is a one-time measurement that takes a temperature in approximately 6-15 seconds. Removing the probe from the probe well, loading a probe cover, and holding the probe tip in place at the measurement site initiates a Predictive mode measurement. The monitor sounds a tone to indicate the end of a predictive measurement.

Direct mode

Direct mode provides continual temperature measurements. For oral and rectal measurements, it is recommended to measure temperature until the temperature stabilizes or for 3 minutes. For axillary measurements, it is recommended to measure temperature until the temperature stabilizes or for 5 minutes. The monitor changes to Direct mode approximately 60 seconds after the probe is removed from the probe well.



CAUTION The monitor does not retain Direct mode temperatures in memory unless there is a physiological temperature alarm condition. If there is a physiological temperature alarm condition, the monitor automatically saves the measurement in the patient record. For temperature measurements that are within normal range, it is important to note the temperature before removing the thermometer probe from the measurement site and then manually record it in the patient record. Once the temperature probe is returned to the well, the temperature measurement is removed from the Home tab

After 10 minutes of using the Direct mode, the monitor stops updating the measurement, generates a technical alarm condition, and clears the measurement.

Take a temperature in the Predictive mode



WARNING Inaccurate measurement risk. To ensure optimal accuracy, always confirm that the correct mode and site are selected.



CAUTION Probe covers are disposable, nonsterilized, and single-use. Probes are also nonsterilized. Do not autoclave probes and probe covers. Ensure that probe covers are disposed of according to facility requirements or local regulations.

1. Remove the temperature probe from the probe well.
The monitor sounds a tone as it enters the ready state.
2. Insert the probe into a new probe cover and press the probe handle down firmly.
3. Touch **Temperature site control** to select the measurement site: oral, pediatric axillary, or adult axillary.
4. Hold the probe tip in place at the measurement site.

While the measurement is being obtained, the temperature frame displays the process indicator.

The monitor sounds a tone when the final temperature is obtained (in approximately 6 to 15 seconds). The temperature frame continues to display the temperature in degrees Fahrenheit and degrees Celsius even after the probe is returned to the probe well.

5. To switch to the Direct mode, touch **Direct mode** after you acquire the Predictive mode measurement. The temperature frame in the lower-left corner changes to "MODE: Direct..." as it switches to Direct mode.

The monitor sounds a tone at the start of a Direct mode measurement.

Take a temperature in the Direct mode

Direct mode displays the temperature of the probe as long as the probe tip remains in place at the measurement site and remains within the operating patient temperature range. The patient's temperature will reach final equilibrium in approximately 3 minutes at the oral and rectal measurement sites and approximately 5 minutes at the axillary site.

The monitor enters Direct mode by the following methods.

- After you complete a Predictive mode measurement, touch to change from Predictive to Direct mode. The temperature frame in the lower-left corner changes to "MODE: Direct..." as it switches to the Direct mode.

- Remove the probe from the probe well, load a probe cover, select a temperature site, and expose the probe to ambient air for more than 60 seconds. The temperature frame changes to "MODE: Direct...".
- If you have a patient whose body temperature is below the normal temperature range and you follow the previous step, the probe sensor identifies this condition and turns off the probe preheater in order to accommodate the lower body temperature measurement.



WARNING Inaccurate measurement risk. To ensure optimal accuracy, always confirm that the correct mode and site are selected.



WARNING Patient injury risk. Do not exceed the recommended temperature measurement durations in Direct mode. Continuous measurement durations of 3 minutes at the oral and rectal sites and 5 minutes at the axillary site are recommended for accurate measurement. Do not continuously measure beyond 10 minutes in any mode.



CAUTION Probe covers are disposable, nonsterilized, and single-use. Probes are also nonsterilized. Do not autoclave probes and probe covers. Ensure that probe covers are disposed of according to facility requirements or local regulations.

1. Remove the temperature probe from the probe well.
The monitor sounds a tone as it enters the ready state.
2. Insert the probe into a new probe cover and press the probe handle down firmly.
3. Touch **Temperature site control** to choose from the measurement site: oral, pediatric axillary, or adult axillary.
The temperature frame changes to Direct mode approximately 60 seconds after the probe is removed from the probe well.
The monitor sounds a tone to indicate the start of a Direct mode measurement.
4. Hold the probe tip in place at the oral or rectal measurement site for a total of 3 minutes and at the axillary site for 5 minutes.
5. While the measurements are being obtained, the temperature frame displays the patient's continuous temperature measurements in degrees Fahrenheit and degrees Celsius.

Note The monitor does not retain Direct mode temperatures in memory. Therefore, it is important to note the temperature before removing the probe from the measurement site and then manually record it in the patient record.

6. Remove the probe after the temperature measurement is obtained and firmly press the eject button on the top of the probe to release the probe cover.
7. Return the probe to the probe well to continue taking temperatures in the Predictive mode.

Take a temperature at the rectal site



WARNING Patient injury risk. When taking rectal temperatures, insert the probe tip only 5/8 inch (approximately 1.5 cm) inside the rectum of adults and only 3/8 inch (approximately 1 cm) inside the rectum of children to avoid the risk of bowel perforation.



WARNING Cross-contamination or nosocomial infection risk. Thorough hand-washing greatly reduces the risk of cross-contamination and nosocomial infection.



WARNING Patient injury risk. Do not exceed the recommended temperature measurement durations in Direct mode. Continuous measurement durations of 3 minutes at the oral and rectal sites and 5 minutes at the axillary site are recommended for accurate measurement. Do not continuously measure beyond 10 minutes in any mode.



WARNING Inaccurate measurement risk. To ensure optimal accuracy, always confirm that the correct mode and site are selected.



CAUTION Probe covers are disposable, nonsterilized, and single-use. Probes are also nonsterilized. Do not autoclave probes and probe covers. Ensure that probe covers are disposed of according to facility requirements or local regulations.

1. Remove the rectal temperature probe from the rectal probe well.
The monitor sounds a tone as it enters the ready state. The Temperature Site Control defaults to the rectal site.
2. Insert the rectal probe into a new probe cover and press the probe handle down firmly.
3. Perform a rectal temperature measurement using medical best practices. While the measurement is taking place, the temperature frame displays the process indicator.
4. The monitor sounds a tone when the final temperature is reached (in approximately 10 to 13 seconds). The temperature frame continues to display the temperature in degrees Fahrenheit and degrees Celsius even after the probe is returned to the probe well.

Note To switch to the Direct mode, touch **Direct mode** after the Predictive mode measurement is acquired. The temperature frame (in the lower-left corner) changes to "MODE: Direct..." as it switches to the Direct mode. The monitor sounds a tone to indicate the start of a Direct measurement.

Note The monitor does not retain Direct mode temperatures in memory. Therefore, it is important to note the temperature before removing the probe from the measurement site and then manually record it in the patient record.

5. Remove the probe after the temperature measurement is complete and firmly press the eject button on the top of the probe to release the probe cover.
6. Return the probe to the probe well.

Braun ThermoScan[®] PRO 6000 thermometer

The Braun ThermoScan Pro 6000 thermometer enables you to transfer an ear temperature measurement to the monitor.

Read the thermometer manufacturer's directions for use before attempting to configure, use, troubleshoot, or maintain the thermometer.



WARNING Liquids can damage electronics inside the thermometer. Prevent liquids from spilling on the thermometer. If liquids are spilled on the thermometer, dry off the thermometer with a clean cloth. Check for proper operation and accuracy. If liquids possibly entered the thermometer, remove the thermometer from use until it has been properly dried, inspected, and tested by qualified service personnel.



CAUTION Probe covers are disposable, nonsterilized, and single-use. The thermometer is also nonsterilized. Do not autoclave the thermometer and probe covers. Ensure that probe covers are disposed of according to facility requirements or local regulations.



CAUTION The thermometer has no user-serviceable parts. If service is required, call your nearest Welch Allyn Customer Service or Technical Support facility.



CAUTION Store the thermometer and probe covers in a dry location, free from dust and contamination and away from direct sunlight. Keep the ambient temperature at the storage location fairly constant and within the range of 50°F to 104°F (10°C to 40°C).

Take a temperature at the ear site



WARNING Probe covers are single-use only. Re-use of a probe cover may result in spread of bacteria and cross-contamination.



WARNING Inaccurate measurement risk. Use only Braun ThermoScan probe covers with this thermometer.



WARNING Inaccurate measurement risk. Frequently inspect the probe window and keep it clean, dry, and undamaged. Fingerprints, cerumen, dust, and other contaminants reduce the transparency of the window and result in lower temperature measurements. To protect the window, always keep the thermometer in the accessory dock when the thermometer is not in use.



CAUTION Inaccurate measurement risk. Before taking a temperature measurement, make sure that the ear is free from obstructions and excess cerumen build-up.



CAUTION Inaccurate measurement risk. The following factors can affect ear temperature measurements for up to 20 minutes:

- The patient was lying on his or her ear.
- The patient's ear was covered.
- The patient was exposed to very hot or very cold temperatures.
- The patient was swimming or bathing.
- The patient was wearing a hearing aid or an ear plug.



CAUTION Inaccurate measurement risk. If ear drops or other ear medications have been placed in one ear canal, take the temperature in the untreated ear.

Note A temperature measurement taken in the right ear might differ from a measurement taken in the left ear. Therefore, always take the temperature in the same ear.

Note When the monitor receives an ear temperature measurement, it displays the measurement on the Home tab. If the Home tab already contains a temperature measurement, the new measurement overwrites it.

To take a measurement and transfer it to the monitor:

1. Make sure that the monitor is powered on.
2. Remove the ear thermometer from the accessory dock.
3. Locate the probe cover box in the accessory dock.
4. Firmly push the probe tip into the probe cover box.

When the probe cover is in place, the thermometer turns on automatically.

5. Wait for the ready beep and three dashes to appear on the thermometer display.
6. Fit the probe snugly into the ear canal and then push and release **Start**.
 - If the probe is positioned correctly in the ear canal the ExacTemp light flashes. When the thermometer detects an accurate measurement, the ExacTemp light is continuously on, a long beep signals the end of the measurement, and the display shows the result.
 - If the probe is positioned incorrectly in the ear canal or is moved during the measuring process, the ExacTemp light goes out, a sequence of short beeps sounds, and the error message POS (position error) appears.
7. When you are finished taking the temperature, press the ejector button to eject the used probe cover.
8. Return the thermometer to the accessory dock.

The LED on the dock flashes while the measurement is being transferred.

After the transfer is complete, the temperature and the temperature scale appear on the Home tab according to the monitor settings.

Note Only the latest measurement is transferred to the monitor.

Note Measurements that have already been transferred to the monitor cannot be transferred again.

For more information about thermometer functionality, refer to the thermometer manufacturer's directions for use.

Change the temperature scale on the ear thermometer

Refer to the thermometer manufacturer's directions for use to change between Celsius and Fahrenheit.

Charge the ear thermometer battery

To charge the battery pack:

1. Place the thermometer in the accessory dock.
2. Make sure that the monitor is connected to AC power.
3. Make sure that the monitor is powered on.

The LED on the dock indicates the charging status of the battery pack:

- Orange: The battery pack is charging.
- Green: The battery pack is charged.
- Not illuminated: The battery pack is not charging.

Note The battery pack continues to charge while the monitor is in Display power saving mode.

Note It is strongly recommended that you use only the Welch Allyn rechargeable battery pack in the thermometer because the dock cannot charge other batteries.

SpO2

SpO2 and pulse rate monitoring continuously measures functional oxygen saturation of arteriolar hemoglobin as well as the pulse rate in a patient through a pulse oximeter. SpO2 measurements are updated each second \pm 0.5 seconds.

The SpO2 sensors provided by Nonin, Masimo, and Nellcor for use with the monitor have been tested for biocompatibility in accordance with ISO 10993.

SpO2 frame

The SpO2 frame displays data and the controls used in pulse oximetry measurements.

The frame provides a numeric view and a waveform view of SpO2 data. You can toggle between views by touching the left side of the frame.

The SpO2 frame remains blank if no SpO2 measurement has been acquired.

SpO2 numeric view

The numeric view indicates the SpO2 saturation percentage and the pulse amplitude. Features of this view differ, based on the type of sensor enabled and the profile selected.

The SpO2 saturation percentage ranges between zero and 100. The SpO2 reading is updated each second \pm 0.5 seconds.

Pulse amplitude

The pulse amplitude bar, shown when you are in the Spot profile, indicates the pulse beat and shows the relative pulse strength. More bars illuminate as the detected pulse gets stronger.

Level of perfusion

The level of perfusion (LofP) is a relative reading of pulse strength at the monitoring site. The LofP is a numerical value that indicates the strength of the infrared (IR) signal returning from the monitoring site. The LofP display ranges from .02 percent (very weak pulse strength) to 20 percent (very strong pulse strength). The LofP is a relative number

and varies between monitoring sites and from patient to patient, as physiological conditions vary.

Masimo displays the LofP as a numeric value and refers to it as Perfusion Index. Nonin displays the LofP as a color value (yellow or red) only when the LofP is low, based on the sensor's algorithm.

During sensor placement, the LofP can be used to evaluate the appropriateness of an application site by looking for the site with the highest LofP number. Placing the sensor at the site with the strongest pulse amplitude (the highest LofP number) improves performance during motion. Monitor the trend of the LofP for changes in physiological conditions.

SatSeconds™ alarm management

The SatSeconds feature is an SpO2 alarm management system available only with monitors that are equipped with Nellcor™ SpO2 OxiMax™ Technology.

The SatSeconds feature is the product of the time and magnitude that a patient falls outside of the SpO2 alarm limits. For example, three points below the alarm limit for 10 seconds equals 30 SatSeconds. An alarm is triggered only when a desaturation event reaches the SatSeconds limit. The SatSeconds feature is clinician controlled and can be set to 0, 10, 25, 50, or 100 SatSeconds. If a desaturation event resolves on its own within the preset time, the clock will automatically reset and the monitor will not alarm.

Note The SatSeconds feature has a built-in safety protocol that sounds an alarm whenever three SpO2 violations of any amount or duration occur within a 1-minute period.

SpO2 waveform view

The waveform view shows the real-time SpO2 plethysmograph waveform. Authorized personnel can select the waveform sweep speed in Advanced settings.

For additional normalization and waveform information, refer to the manufacturer's *Directions for use*.

Interval SpO2 measurement

You must be in either the Intervals or Office profile to set intervals. Refer to the "Intervals" section for directions on setting intervals. For a description of the effect on displayed and transmitted SpO2 pulse rate values, refer to the SpO2 manufacturer's directions for use.

Measure SpO2 and pulse rate

The SpO2 sensor measures oxygen saturation and pulse rate. Oxygen saturation is displayed as a percentage from zero (0) to 100%. The oxygen saturation and pulse rate are updated and refreshed each second, ± 0.05 seconds.



WARNING Inaccurate measurement risk. Use only Masimo SET or MX-5 sensors and accessories on Masimo-equipped monitors.



WARNING Inaccurate measurement risk. Use only Nellcor sensors and accessories on Nellcor-equipped monitors.



WARNING Inaccurate measurement risk. Severe anemia may cause erroneous SpO2 readings.



WARNING Inaccurate measurement risk. The pulse oximeter can be used during defibrillation, but the readings may be inaccurate for up to 20 seconds.



WARNING Inaccurate measurement risk. Misapplied sensors or sensors that become partially dislodged may cause either over or under reading of actual arterial oxygen saturation.



WARNING Inaccurate measurement risk. Venous congestion may cause under reading of actual arterial oxygen saturation. Therefore, assure proper venous outflow from monitored site. Sensor should not be below heart level (e.g. sensor on hand of a patient in a bed with arm dangling to the floor).



WARNING Inaccurate measurement risk. Use only Nonin sensors and accessories on Nonin-equipped monitors.



WARNING The pulsations from intra-aortic balloon support can increase the pulse rate displayed on the monitor. Verify the patient's pulse rate against the ECG heart rate.



WARNING Patient injury risk. Do not attempt to reprocess, recondition, or recycle any sensors or patient cables. Doing so might damage electrical components.



WARNING Patient injury risk. The pulse oximeter is NOT intended for use as an apnea monitor.



WARNING Patient injury risk. To avoid cross contamination only use Masimo single use sensors on the same patient.



WARNING Patient injury risk. Do not use tape to secure the sensor to the site; this can restrict blood flow and cause inaccurate readings. Use of additional tape can cause skin damage or damage the sensor.



WARNING Unless otherwise specified, do not sterilize sensors or patient cables by irradiation, steam, autoclave or ethylene oxide. See the cleaning instructions in the Directions for use for the Masimo re-useable sensors.



WARNING Patient injury risk. Loss of pulse signal can occur when the patient has severe anemia or hypothermia.



WARNING SpO2 is empirically calibrated in healthy adult volunteers with normal levels of carboxyhemoglobin (COHb) and methemoglobin (MetHb).



WARNING High-intensity extreme lights, such as pulsating strobe lights, directed on the sensor may not allow the pulse oximeter to obtain vital sign readings.



WARNING Pulse rate measurement might not detect certain arrhythmias because it is based on the optical detection of a peripheral flow pulse. Do not use the pulse oximeter as a replacement or substitute for ECG-based arrhythmia analysis.



WARNING Use the pulse oximeter as an early warning device. As you observe a trend toward patient hypoxemia, use laboratory instruments to analyze blood samples to better understand the patient's condition.



WARNING The accuracy of SpO₂ measurements can be affected by any of the following:

- elevated levels of total bilirubin
- elevated levels of Methemoglobin (MetHb)
- elevated levels of Carboxyhemoglobin (COHb)
- hemoglobin synthesis disorders
- low perfusion at the monitored site
- the presence of concentrations of some intravascular dyes, sufficient to change the patient's usual arterial pigmentation
- patient movement
- patient conditions such as shivering and smoke inhalation
- motion artifact
- painted nails
- poor oxygen perfusion
- hypotension or hypertension
- severe vasoconstriction
- shock or cardiac arrest
- venous pulsations or sudden and significant changes in pulse rate
- proximity to an MRI environment
- moisture in the sensor
- excessive ambient light, especially fluorescent
- the use of the wrong sensor
- a sensor applied too tightly



CAUTION If using pulse oximetry during full body irradiation, keep the sensor out of the irradiation field. If the sensor is exposed to the irradiation, the reading might be inaccurate or the unit might read zero for the duration of the active irradiation period.



CAUTION The instrument must be configured to match your local power line frequency to allow for the cancellation of noise introduced by fluorescent lights and other sources.



CAUTION Exercise caution when applying a sensor to a site with compromised skin integrity. Applying tape or pressure to such a site may reduce circulation and/or cause further skin deterioration.



CAUTION If the Low Perfusion message is frequently displayed, find a better perfused monitoring site. In the interim, assess the patient and, if indicated, verify oxygenation status through other means.



CAUTION Circulation distal to the sensor site should be checked routinely.



CAUTION Do not modify or alter the sensor in any way. Alterations or modification may affect performance and/or accuracy.

1. Verify that the sensor cable is connected to the monitor.



WARNING Patient injury risk. The sensor and extension cable are intended only for connection to pulse oximetry equipment. Do not attempt to connect these cables to a PC or any similar device. Always follow the sensor manufacturer's directions for care and use of the sensor.

2. Clean the application site. Remove anything, such as nail polish, that could interfere with sensor operation.

Note Do not use disposable sensors on patients who have allergic reactions to the adhesive.

3. Attach the sensor to the patient according to the manufacturer's directions for use, observing all warnings and cautions.

Note If a sterile sensor is required, select a sensor that has been validated for sterilization, and follow the sensor manufacturer's directions for sterilizing the sensor.

Place the sensor and the NIBP cuff on different limbs to reduce unnecessary alarms when you monitor these parameters at the same time.

Note Consult the sensor manufacturer's instructions for selecting the correct sensor.

4. Confirm that the monitor displays SpO₂ and pulse rate data within 6 seconds after connecting the sensor to the patient.



WARNING Patient injury risk. Incorrect sensor application or excessive duration of sensor use can cause tissue damage. Inspect the sensor site periodically as directed in the sensor manufacturer's instructions.

While SpO₂ is being measured, the displayed pulse rate is acquired from the sensor. If SpO₂ is not available, the pulse rate is acquired from NIBP. The monitor identifies SpO₂ or NIBP as the pulse rate source.

An alarm sounds if you detach the sensor during a measurement in intervals mode.

If SpO₂ is being measured continuously on a patient for an extended period, change the sensor location at least every three hours or as indicated by the sensor manufacturer's instructions.

Pulse rate frame

The pulse rate frame is located in the upper right of the Home tab. The pulse rate frame displays data, information, and the controls used in reading pulse rates.

Typically, the pulse rate is derived from the SpO₂ sensor. If SpO₂ is not available, the pulse rate is derived from NIBP or manually obtained.

The source of the pulse rate is displayed beneath the numeric representation of the pulse rate.



WARNING Inaccurate measurement risk. Pulse rate measurements generated through the blood pressure cuff or through SpO2 are subject to artifact and might not be as accurate as heart rate measurements generated through ECG or manual palpation.

Configure pulse rate alarms

You must be in the Intervals profile to configure the pulse rate alarms.

1. Touch the **Alarms** tab.
2. Touch the **Pulse rate** vertical tab.
3. Using either the keypad or ▲ or ▼, enter the desired upper and lower alarm limits.
4. Touch the **Home** tab.

The new alarm settings appear in the Pulse Rate Alarm Limit control button.

SpO2 alarms

SpO2 alarm signal delays

Alarm signal delays are built into the system and are not accessible by clinicians.

The lower range of signal delays is 50–98%. The upper range of signal delays is 52–100%.

Refer to the SpO2 manufacturer's directions for use for additional information on alarm signal delays.

Configure SpO2 alarms

1. Verify that you are using the Intervals profile, which contains the Alarms tab.
2. Touch the **Alarms** tab.
3. Touch the **SpO2** vertical tab.
4. Using the keypad or ▲ or ▼, enter the desired upper and lower alarms limits.
5. Touch the **Home** tab.

The new alarm settings appear in the Alarm Limit control button.

Modifiers and manual parameters

Modifiers enable you to save additional information for the measurements for a specific patient:

- Standard modifiers are the same on all devices
- Custom modifiers are specific to a facility or a unit; custom modifiers are set up during the initial configuration requested by your facility.

Manual parameters are core measurements that you can enter physically on the monitor, such as height, weight, temperature, and pain.

The Manual parameters frame, accessed when you are in the Office profile, is located in the lower-right corner of the Home tab and can display up to five designated parameters.

Enter manual parameters

Note Authorized personnel can select and configure the Manual parameters frame in Advanced settings. Only four parameter types appear in the Manual parameters frame.

1. On the Home tab, press and hold the parameter desired.
2. Using either the keypad or ▲ or ▼, manually enter information for the parameter chosen.

Note Ensure that the current patient ID is correct before saving.

3. Touch **Ok** to capture the parameter that you entered..
4. Touch Save to save the data.

Note During intervals, each automatic and manual save of patient measurements clears all measurements from the Manual parameters frame.

Configuration tool

The configuration tool is a web-based tool on the Welch Allyn website. The configuration tool enables you to set the device settings for your facility. For more information, visit the Connex Spot Monitor page on the Welch Allyn website.

Custom scoring



WARNING Risk to patient safety. Custom scores and messages serve as guides to your facility's protocols; **do not substitute custom scores for patient physiological alarms**. Appropriate alarms settings must be set and maintained to ensure patient safety.

Custom scoring is defined through the Configuration tool on the Welch Allyn web site. The order in which the custom score parameters are entered in the Configuration tool is the order in which they will appear in the custom scoring.

Custom scoring enables you to configure specific parameters, based on your institution's practice standards, that calculate scores for patient monitoring. These scores generate messages regarding the patient status, based on the parameters chosen. These messages are provided only as reminders.

Advanced settings

Consult the Connex Spot Monitor Service manual for Advanced settings.

Maintenance and service

Perform periodic checks

1. Verify the following at least daily.
 - The audio speaker tone, especially at startup
 - The touchscreen alignment
 - The date
 - The time
2. Visually inspect the following at least weekly.
 - The monitor for any damage or contamination
 - All cables, cords, and connector ends for damage or contamination
 - All mechanical parts, including covers, for integrity
 - All safety-related labeling for legibility and adhesion to the monitor
 - All accessories (cuffs, tubing, probes, sensors) for wear or damage
 - Documentation for current revision of the monitor
3. Visually inspect the following at least monthly
 - The mobile stand wheels for wear and faulty operation
 - The mounting screws on wall units or carts for looseness and wear

Update settings, replace items, or call for service as necessary, based on results from a visual inspection. Do not use the monitor if you see any signs of damage. Qualified service personnel must check any monitor that is damaged for proper operation before putting the monitor back into operation.

Replace the monitor battery



WARNING Personal injury risk. Improper handling of the battery can lead to heat generation, smoke, explosion or fire. Do not short-circuit, crush, incinerate, or disassemble the battery. Never dispose of batteries in refuse containers. Always recycle batteries according to national or local regulations.

1. Turn the monitor upside down to access the battery cover.
2. Locate the battery cover, indicated by .
3. Using a double-slotted screwdriver, loosen the captive screw at the base of the battery cover, and then remove the cover.

4. Remove the old battery from the battery compartment.
5. Disconnect the battery connector from the battery connection port on the monitor.
6. Insert the battery connector for the new battery into the battery connection port on the monitor.
7. Insert the new battery into the battery compartment.
8. Replace the battery cover, and then tighten the captive screw at the bottom of the battery cover.

Note Do not overtighten the screw.

Replace the APM work surface battery

Before removing the APM work surface battery, power down the monitor and disconnect the power cord from the mains outlet.

Note You do not have to remove the APM work surface from the stand to remove the APM work surface battery.

1. Loosen the captive screw on the bottom of the APM work surface that secures the battery cover.

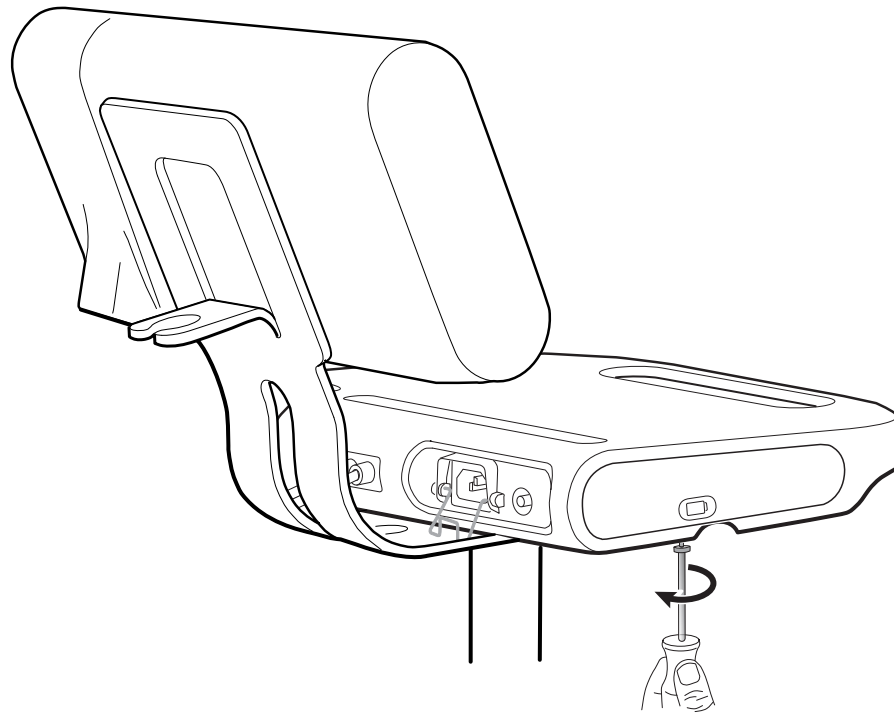

2. Remove the battery cover and put it aside.

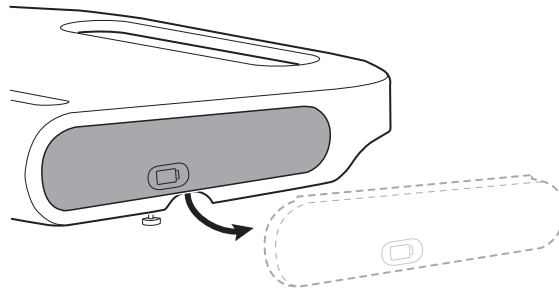

3. Gently lift the latch with one hand and pull the tab on the top of the battery with your other hand to remove the battery from its slot.

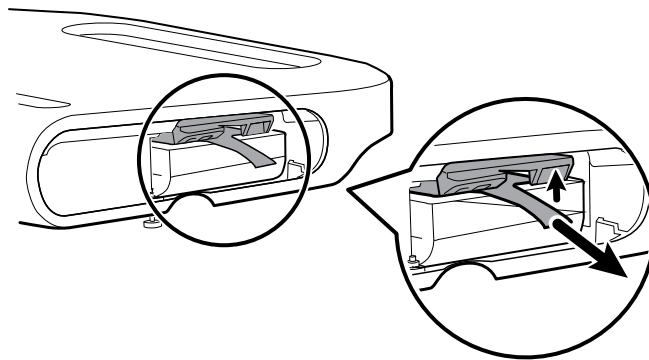

4. Slide the new battery into the slot.

Note Ensure that the tab is facing you on the top of the battery.

5. Replace the battery cover and tighten the captive screw on the bottom of the APM work surface.

Cleaning requirements

This section presents procedures for cleaning the Connex Spot Monitor (including the monitor, stand, APM work surface, accessories, and accessory basket and bins).

Welch Allyn has validated these instructions to be capable of preparing your Connex Spot Monitor devices and above accessories for re-use. Clean on a routine basis according to your facility's protocols and standards or local regulations. If the monitor is on, lock the display.



WARNING Patient injury risk. Clean all accessories, including cables and tubes, before storing the accessories on the device or stand. This helps reduce the risk of cross contamination and nosocomial infection.



WARNING Electric shock hazard. Before cleaning the monitor, disconnect the AC power cord from the mains outlet and the power source.



WARNING Electric shock hazard. DO NOT immerse or autoclave the monitor or accessories. The monitor and the accessories are not heat-resistant.



WARNING Liquids can damage electronics inside the monitor. Prevent liquids from spilling on the monitor.



CAUTION Do not sterilize the monitor. Sterilizing the monitor could harm the device.

If liquids are spilled on the monitor:

1. Power down the monitor.
2. Disconnect the power cord from the mains outlet and the power source.
3. Remove battery pack from the monitor.
4. Dry off excess liquid from the monitor.

Note If liquids possibly entered the monitor, remove the monitor from use until it has been properly dried, inspected, and tested by qualified service personnel.

5. Reinstall battery pack.
6. Reconnect the power cord.
7. Power on the monitor and verify that the monitor functions normally before using it.

Prepare to clean the equipment



CAUTION Some cleaning agents are not appropriate for all components of the device. Use only approved cleaning agents, and observe restrictions noted for some components in the following table. Using unapproved cleaning agents may cause damage to components.



CAUTION Do not use bleach solutions of any kind when cleaning metal electrical contacts. They will damage the device.

Select a cleaning agent from the following table.

Section 1. Approved for all Connex Spot Monitor components

Cleaning agent	Additional information
Accel INTERVention	
Accel TB	
CaviWipes	
Clinell® Universal Wipes	
Oxiver TB	
Sani-Cloth® Plus	
Super Sani-Cloth®	
70 percent isopropyl alcohol solution	Applied to a clean cloth

Section 2. Not approved for all Connex Spot Monitor components

Note The following cleaning agents are NOT approved for cleaning Connex Spot Monitors equipped with the Braun ThermoScan PRO 6000

Cleaning agent	Additional information
Cleancide	
Clorox HealthCare Bleach Germicidal Cleaner	
Sani-Cloth® Bleach	Not approved for cleaning the display
Super HDQ® L10	Dilution rate of ½ oz per gallon of water (1:256) applied to a clean cloth
Tuffie5 Cleaning Wipes	
Virex II (256)	Dilution rate of ½ oz per gallon of water (1:256) applied to a clean cloth
10 percent bleach solution	(.5% - 1% sodium hypochlorite) applied to a clean cloth

Remove liquid spills from the monitor

Liquids can damage electronics inside the monitor. Follow these steps if liquids spill on the monitor.

1. Power down the monitor.
2. Disconnect the power cord from the mains outlet and the power source.
3. Remove battery pack from the monitor.
4. Dry excess liquid from the monitor.
5. Reinstall battery pack.
6. Reconnect the power cord.
7. Power on the monitor and verify that the monitor functions normally before using it.

If liquids possibly entered the monitor, remove the monitor from use until it has been properly dried, inspected, and tested by qualified service personnel.

Clean the equipment

The screen lock blocks the display of patient information and prevents any input, which may be useful when cleaning the display.

Follow the cleaning agent manufacturer's instructions to prepare solution, if applicable, and clean all exposed surfaces of the monitor, APM work surface, accessory bin(s) and basket, cords and cables, and stand. Wipe all surfaces until no visible soil remains. Change the wipe or cloth throughout the cleaning procedure as needed.



WARNING Electric shock hazard. Do not open the monitor or attempt repairs. The monitor has no user-serviceable internal parts. Only perform routine cleaning and maintenance procedures specifically described in this manual. Inspection and servicing of internal parts shall only be performed by qualified service personnel.



CAUTION Sterilizing the monitor could damage the device.

1. Disconnect the AC power cord from the mains outlet.
2. Wipe the top of the monitor.
3. Wipe the sides, front, and rear of the monitor.
4. Avoid residual film buildup on the LCD screen. After cleaning and disinfecting, wipe the LCD screen with a clean cloth dampened with water, and then wipe the screen dry with a dry clean cloth.
5. Wipe the bottom of monitor.
6. Wipe the APM work surface.
7. Wipe the accessory bins or basket.
8. Wipe the AC power cord and the APM work surface power/USB cable assembly.
9. Wipe the stand from top to bottom.

Dry the equipment

1. Allow all components except the LCD screen to air dry.
2. Wipe the LCD screen dry with a clean cloth.

Store the device

Store the device according to facility guidelines to keep the device clean, dry, and ready for service.

Cleaning accessories

Accessories include components like blood pressure cuffs and hoses, SpO2 sensors and cables, thermometers, and the barcode scanner. Follow accessory manufacturer's instructions for cleaning and disinfection.

For the Braun ThermoScan PRO 6000 thermometer, use only the approved cleaning agents published in the manufacturer's instructions for cleaning. Unapproved cleaning agents can damage the device and interfere with data transmission.

Clean the Braun ThermoScan PRO 6000 contacts

Debris that accumulates on the Braun ThermoScan PRO 6000 electrical contacts can interfere with data transmission. Welch Allyn recommends cleaning the contacts on the thermometer and the dock once every 4 months to maintain optimal performance.



CAUTION Do not use bleach solutions of any kind when cleaning metal electrical contacts. They will damage the device.

1. Slightly dampen a cotton swab with 70% isopropyl alcohol.

2. Remove the thermometer from the dock and clean the metal electrical contacts on the thermometer with the cotton swab.

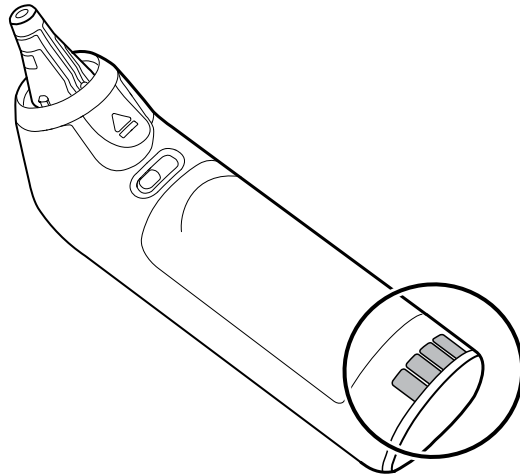

3. Place the thermometer aside for 1 minute, allowing the contacts to air dry.
4. Clean the metal electrical contacts on the device dock with the cotton swab.

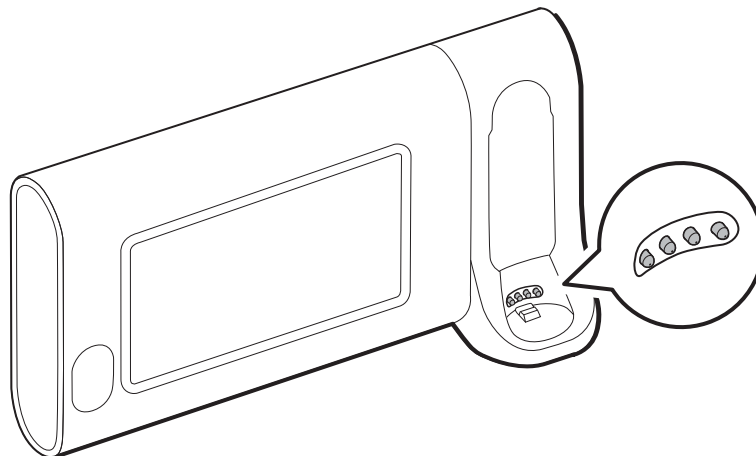

5. Allow the contacts to air dry for 1 minute.
6. Optional step to improve performance: **On the dock only**, apply DeoxIT Gold® to the tip of each electrical contact. Do not apply DeoxIT Gold to the thermometer.
No drying time is required.
7. Return the Braun thermometer to the dock.

Troubleshooting

This section presents tables of technical alarm and information messages, as well as problem descriptions that do not generate messages, to help you troubleshoot issues on the monitor.

Note Problem descriptions without messages appear at the end of this section.

When the monitor detects certain events, a message appears in the Device Status area at the top of the screen. Below are the message types.

- Information messages, which appear on a blue background.
- Very low-priority alarms, which appear on a cyan background.
- Low- and medium-priority alarms, which appear on an amber background.
- High-priority alarms, which appear on a red background.

Technical alarm messages are low or very low priority unless noted in the Message column.

Alarm logs are not viewable by clinicians. However, all logs are transferred to Welch Allyn on a regularly scheduled basis. In the event of an unplanned power failure, all information, including device logs and patient data, are retained on the system.

You can dismiss a message by touching the message on the screen or, for some messages, you can wait for the message to time out.

To use these tables, locate the message that displays on the monitor in the left column of the table. The remainder of the row explains possible causes and suggests actions that can resolve the issue.

Note Instructions to "Call for service" in the following tables mean that you should contact qualified service personnel in your facility to investigate the issue.

NIBP messages

Message	Possible cause	Suggested action	Alarm priority
User cancelled NIBP reading.	The NIBP measurement was cancelled by user	Clear the alarm and retry NIBP.	Information
NIBP not functional. 050002	The NIBP measurement is not available	Internal malfunction. If the problem persists, replace the module.	Medium

Message	Possible cause	Suggested action	Alarm priority
Unable to determine NIBP; check connections; limit patient movement. 050003	The NIBP measurement may be inaccurate, patient motion occurred, or the settings for patient readings obtain might not be accurate	Make sure the NIBP settings/patient mode is appropriate. If the problem persists, replace the module.	Medium
Unable to determine NIBP; check connections; limit patient movement. 050004	Excessive artifact, no blood pressure parameters could be calculated	Unable to determine blood pressure. Check connections; restrict patient movement. If problem persists, replace module	Medium
Unable to determine NIBP; check inflation settings. 050005	Low inflation on blood pressure measurement attempt	Make sure the NIBP settings/patient mode is appropriate. If the problem persists, replace the module.	Medium
Unable to determine NIBP; check connections and tubing for kinks. 050006	The NIBP tubing has a kink, or there is a NIBP transducer calibration failure	Internal malfunction. If the problem persists, replace the module.	Medium
Unable to determine NIBP; check connections; limit patient movement. 050007	The blood pressure measurement dumped too soon	Make sure the NIBP settings/patient mode is appropriate. If the problem persists, replace the module.	Medium
Unable to determine NIBP; check connections; limit patient movement. 050008	There were not enough steps on the measurement attempt	Unable to determine blood pressure. Check connections; restrict patient movement.	Medium
Unable to determine NIBP; check inflation settings. 050009	There is invalid patient information for the selected mode	Make sure the NIBP settings/patient mode is appropriate. If the problem persists, replace the module.	Medium
Unable to determine NIBP; check connections; limit patient movement. 05000A	The re-inflation was too late on the measurement attempt	Unable to determine blood pressure. Check connections; restrict patient movement.	Medium
Unable to determine NIBP; check inflation settings. 05000B	There were many re-inflate attempts on the measurement attempt	Unable to determine blood pressure. Check connections; restrict patient movement.	Medium
Unable to determine NIBP; check connections and tubing for kinks. 05000C	Couldn't bleed pressure below safe venous return pressure	Unable to release cuff pressure. Check tubing for kinks and connection integrity.	Medium
No display	The safety check failed on the measurement attempt	Internal malfunction. If the problem persists, replace the module.	
Unable to determine NIBP; check connections; limit	The NIBP pressure is not stable and the transducer zero value cannot be set	The NIBP pressure is not stable and the transducer zero value cannot be set. If problem persists, replace module.	Medium

Message	Possible cause	Suggested action	Alarm priority
patient movement. 05000F			
NIBP not functional. 050105	WACP message CRC mismatch on NIBP module	Internal malfunction. If the problem persists, replace the module.	Very low
NIBP not functional. 050201	This message is not implemented by the NIBP module	Internal malfunction. If the problem persists, replace the module.	Very low
NIBP not functional. 050202	This message is not supported by the NIBP module	Internal malfunction. If the problem persists, replace the module.	Very low
NIBP not functional. 050203	The NIBP module has run out of memory	Internal malfunction. If the problem persists, replace the module.	Very low
NIBP not functional. 050205	The NIBP module has received a invalid parameter	Internal malfunction. If the problem persists, replace the module.	Very low
NIBP not functional. 050206	The parameter provided by the NIBP module is outside of the allowable range for the specified message	Internal malfunction. If the problem persists, replace the module.	Very low
NIBP not functional. 050207	The NIBP module message requires an object, but did not contain one	Internal malfunction. If the problem persists, replace the module.	Very low
NIBP not functional. 050208	The NIBP module object provided with the message could not be deserialized	Internal malfunction. If the problem persists, replace the module.	Very low
NIBP not functional. 050209	The NIBP module object could not be serialized	Internal malfunction. If the problem persists, replace the module.	Very low
NIBP not functional. 05020A	The NIBP module message is performing a request or action when the module state prohibits the request or action.	Internal malfunction. If the problem persists, replace the module.	Very low
NIBP not calibrated. 050503	Factory EEPROM checksum error on NIBP. Units internal configuration was corrupted	Internal malfunction. If the problem persists, replace the module.	Very low
NIBP not functional. 050504	User EEPROM checksum error. Configuration data which can be set in the user's configuration menu was damaged or lost on NIBP	Calibrate the NIBP Module. If problem persists, replace module.	Very low
NIBP not functional. 050505	Post failure of A/D convertor	Internal malfunction. If the problem persists, replace the module.	Very low
NIBP not calibrated. Calibrate the module. 050509	NIBP module calibration failure, the calibration signature is zero	Calibrate the NIBP module.	Very low

Message	Possible cause	Suggested action	Alarm priority
Invalid algorithm. Select correct algorithm and retry. 05050A	Invalid NIBP Algorithm. NIBP component software tried to configure the sensor in an illegal manner	Verify the algorithm. If the problem persists, replace the module.	Very low
NIBP not functional. 050513	Invalid NIBP initiation code	Internal malfunction. If the problem persists, replace the module.	Very low
Invalid patient mode. Select correct patient mode and retry. 050514	Invalid patient mode on NIBP. The NIBP component software tried to configure the sensor in an illegal manner	Verify correct patient mode. If the problem persists, replace the module.	Very low
NIBP not functional. 050515	Invalid module configuration for NIBP	Internal malfunction. If the problem persists, replace the module.	Very low
NIBP not functional. 050516	NIBP module malfunction	Internal malfunction. If the problem persists, replace the module.	Very low
Ambient temperature out of range. Clear error and retry. 050517	Ambient temp out of range on NIBP	Restore device to normal temperature ranges and try again.	Very low
Low battery. Plug into outlet. 050518	The NIBP module power rail is too low	Plug device into an AC outlet to charge the battery.	Very low
Battery overcharged. Disconnect from outlet. 050519	The NIBP module power rail is too high.	Battery is overcharged. Remove from charging source.	Very low
NIBP not calibrated. Calibrate the module. 050601	NIBP failed to load safety processors calibration record from EEPROM	Calibrate the NIBP module. If the problem persists, replace the module.	Very low
NIBP not functional. 050602	NIBP safety processor failed ROM checksum	Internal malfunction. If the problem persists, replace the module.	Very low
NIBP not calibrated. Calibrate the module. 050603	NIBP safety processor not calibrated, missing calibration signature	Calibrate the NIBP module. If the problem persists, replace the module.	Very low
Cuff pressure limits exceeded. 050604	NIBP system failure. Overpressure	Restrict patient movement.	Medium
Premature auto cycle skipped. 050605	NIBP auto cycle skipped, SVRP requirement not satisfied	Cuff pressure is not below safety return pressure long enough to allow a cycle to occur.	Very low
Cuff pressure too high. Clear error to retry. 050606	NIBP cuff pressure above SVRP for too long	Verify cuff connections. If the problem persists, replace the module.	Medium
NIBP not functional. 050607	NIBP cannot clear the failsafe alerts	Internal malfunction. If the problem persists, replace the module.	Very low
NIBP not functional. 050608	NIBP safety processor has stopped responding	Internal malfunction. If the problem persists, replace the module.	Very low

Message	Possible cause	Suggested action	Alarm priority
Stat mode requested too soon. Clear to retry. 050609	NIBP excessive stat mode time. The time between readings is less than one minute and the readings plus time between readings result in the device taking over 15 minutes to complete the averaging cycle.	Internal malfunction. If the problem persists, replace the module.	Very low
Unable to determine NIBP; check connections and tubing for kinks. 05060A	NIBP transducers are not matched	The transducer are above 5 mmHg and the difference in pressure is greater than 40 mmHg. Check cuff for pinched or obstructed tubing. If the problem persists, replace the module.	Medium
NIBP not calibrated. Calibrate the module. 05060B	Factory EEPROM checksum error on NIBP. Units internal configuration was corrupted	Calibrate the NIBP module. If the problem persists, replace the module.	Very low
NIBP not functional. 05060C	NIBP command not implemented	Internal malfunction. If the problem persists, replace the module.	Very low
NIBP not functional. 05060D	NIBP wrong data count	Internal malfunction. If the problem persists, replace the module.	Very low
NIBP not functional. 05060E	NIBP data range error	Internal malfunction. If the problem persists, replace the module.	Very low
NIBP not functional. 05060F	NIBP no POST error to clear	Internal malfunction. If the problem persists, replace the module.	Very low
NIBP not functional. 050610	NIBP cannot clear this POST error	Internal malfunction. If the problem persists, replace the module.	Very low
NIBP not functional. 050611	NIBP command not command type	Internal malfunction. If the problem persists, replace the module.	Very low
NIBP not functional. 050612	NIBP communication timeout	Internal malfunction. If the problem persists, replace the module.	Very low
NIBP not functional. 050613	NIBP response header wrong	Internal malfunction. If the problem persists, replace the module.	Very low
NIBP not functional. 050614	NIBP response checksum wrong	Internal malfunction. If the problem persists, replace the module.	Very low
NIBP not functional. 050615	Too much NIBP data was received	Internal malfunction. If the problem persists, replace the module.	Very low
NIBP not functional. 050616	NIBP FEPROM erase error	Internal malfunction. If the problem persists, replace the module.	Very low
NIBP not functional. 050617	NIBP FEPROM programming error	Internal malfunction. If the problem persists, replace the module.	Very low
NIBP not functional. 050618	Invalid NIBP target pressure	Internal malfunction. If the problem persists, replace the module.	Very low

Message	Possible cause	Suggested action	Alarm priority
Check cuff inflation settings.	Cuff inflation target was overridden due to max pressure being too low	Change cuff inflation target or maximum pressure so that the cuff inflation target is at least 20 mmHg lower than maximum pressure.	Information
Tube type does not match device configuration.	Switching to step BP	Change tube type to dual lumen or change the algorithm configuration to step BP	Information
NIBP not functional. 05FF01	Unrecognized WACP parameter received from sensor	Internal malfunction. If the problem persists, replace the module.	Very low
NIBP not functional. 05FF02	Timeout waiting for sensor response	Internal malfunction. If the problem persists, replace the module.	Very low
NIBP not functional. 05FF03	Error deserializing the WACP message received from the sensor	Internal malfunction. If the problem persists, replace the module.	Very low
NIBP not functional. 05FF04	WACP stack send message failure	Internal malfunction. If the problem persists, replace the module.	Very low
NIBP not functional. 05FF05	Timeout waiting for asynchronous sensor message	Internal malfunction. If the problem persists, replace the module.	Very low
NIBP not functional. 05FF06	One or more undetermined numerics when reading status indicates OK	Check connections. Restrict patient movement.	Very low
NIBP not functional. 05FF07	Unrecognized sensor reading status code	Internal malfunction. If the problem persists, replace the module.	Very low
NIBP not functional. 05FF08	Sensor power up failure	Internal malfunction. If the problem persists, replace the module.	Very low
NIBP not functional. 05FF09	WACP rendezvous failure	Internal malfunction. If the problem persists, replace the module.	Very low
NIBP not functional. 05FF0A	Application firmware retrieval error during POST	Internal malfunction. If the problem persists, replace the module.	Very low
NIBP not functional. 05FF0B	Upgrade .pim file is corrupt	Internal malfunction. If the problem persists, replace the module.	Very low
NIBP not functional. 05FF0C	Configured upgrade firmware directory cannot be accessed	Internal malfunction. If the problem persists, replace the module.	Very low
Device configuration issue. 05FF0D	Configured parameter (NIBP or SpO2) used in Intervals is missing	Use configured parameters for Intervals	Very low
NIBP not functional. 05FF0E	The NIBP sensor unexpectedly reset	Clear the error and try again	Very low
NIBP not functional. 05FF0F	The NIBP sensor firmware failed to upgrade	Internal malfunction. If the problem persists, replace the module.	Very low

Message	Possible cause	Suggested action	Alarm priority
Tube type does not match device configuration.	The tube type settings and the actual tube type do not match	Change the tube type setting to match the actual tube type.	Information

SpO2 messages

General SpO2 messages

Message	Possible cause	Suggested action	Alarm priority
SpO2 not functional. 044800	The SpO2 power on self test failed	Internal hardware malfunction in SpO2 module. Replace the module.	Very low
SpO2 rebooting. 044900	The SpO2 module is rebooting	Informational error. The host software is attempting to clear an error by rebooting the SpO2 module. No action required.	Very low
SpO2 rebooting. 044901	The SpO2 module stopped sending data	Informational error. The host software is attempting to clear an error by rebooting the SpO2 module. No action required.	Very low
SpO2 rebooting. 044902	SpO2 received a packet with bad CRC from module	Informational error. The host has received a packet with bad CRC from the SpO2 module. The packet in question is ignored. No action required.	Very low
SpO2 rebooting. 044903	The SpO2 power on self test failed	Internal hardware malfunction in SpO2 module. Replace the module.	Very low
SpO2 rebooting. 044904	The SpO2 power on self test timed out	Internal hardware malfunction in SpO2 module. Replace the module.	Very low

Masimo messages

Message	Possible cause	Suggested action	Alarm priority
Sensor not connected. Clear to retry. 040600	The SpO2 cable is not connected	Connect SpO2 cable. If the problem is still present, replace the SpO2 sensor. If the problem is still present, verify the module functionality by replacing the sensor with an applicable SpO2 tester. If the message persists, replace the module.	Very low
Replace the SpO2 cable. 040700	The SpO2 cable life has expired	Replace the SpO2 cable. If the problem is still present, verify module functionality by replacing the sensor with an applicable SpO2	Very low

Message	Possible cause	Suggested action	Alarm priority
		tester. If the message persists, replace the module.	
Replace the SpO2 cable. 040800	The SpO2 cable is incompatible with the monitor	Replace the SpO2 cable. If the problem is still present, verify module functionality by replacing the sensor with an applicable SpO2 tester. If the message persists, replace the module.	Very low
Replace the SpO2 cable. 040900	The SpO2 cable is not recognized by the monitor	Replace the SpO2 cable. If the problem is still present, verify module functionality by replacing the sensor with an applicable SpO2 tester. If the message persists, replace the module.	Very low
Replace the SpO2 cable. 040a00	The SpO2 cable is defective	Replace the SpO2 cable. If the problem is still present, verify module functionality by replacing the sensor with an applicable SpO2 tester. If the message persists, replace the module.	Very low
Sensor not connected. Clear to retry. 040b00	The SpO2 sensor is not connected to the monitor	Connect SpO2 sensor. If the problem is still present, replace the SpO2 cable. If the problem is still present, verify the module functionality by replacing the sensor with an applicable SpO2 tester. If the message persists, replace the module.	Very low
The sensor has expired. Replace the SpO2 sensor. 040c00	The SpO2 sensor has expired	Replace SpO2 sensor. If the problem is still present, replace the SpO2 cable. If the problem is still present, verify the module functionality by replacing the sensor with an applicable SpO2 tester. If the message persists, replace the module.	Very low
Incompatible sensor. Replace the SpO2 sensor. 040d00	The SpO2 sensor is not recognized by the monitor	Replace SpO2 sensor. If the problem is still present, replace the SpO2 cable. If the problem is still present, verify the module functionality by replacing the sensor with an applicable SpO2 tester. If the message persists, replace the module.	Very low
Incompatible sensor. Replace the SpO2 sensor. 040e00	The SpO2 sensor is not recognized	Replace SpO2 sensor. If the problem is still present, replace the SpO2 cable. If the problem is still present, verify the module functionality by replacing the sensor with an applicable SpO2 tester. If the message persists, replace the module.	Very low

Message	Possible cause	Suggested action	Alarm priority
Replace the SpO2 sensor. 040f00	The SpO2 sensor is defective	Replace SpO2 sensor. If the problem is still present, replace the SpO2 cable. If the problem is still present, verify the module functionality by replacing the sensor with an applicable SpO2 tester. If the message persists, replace the module.	Very low
Replace the SpO2 sensor. Replace the SpO2 cable. 041000	There was a fault with the SpO2 sensor and cable.	Check the sensor and cable connection. If the problem is still present, replace the SpO2 sensor. If the problem is still present, replace the cable. If the problem is still present, verify the module functionality by replacing the sensor with an applicable SpO2 tester. If the message persists replace the module.	Very low
Sensor not connected. Clear to retry. 041100	An adhesive SpO2 sensor is not connected	Connect SpO2 sensor. If the problem is still present, replace the SpO2 cable. If the problem is still present, verify the module functionality by replacing the sensor with an applicable SpO2 tester. If the message persists, replace the module.	Very low
The sensor has expired. Replace the SpO2 sensor. 041200	The adhesive SpO2 sensor is expired	Replace SpO2 sensor. If the problem is still present, replace the SpO2 cable. If the problem is still present, verify the module functionality by replacing the sensor with an applicable SpO2 tester. If the message persists, replace the module.	Very low
Incompatible sensor. Replace the SpO2 sensor. 041300	The adhesive SpO2 sensor is incompatible	Replace SpO2 sensor. If the problem is still present, replace the SpO2 cable. If the problem is still present, verify the module functionality by replacing the sensor with an applicable SpO2 tester. If the message persists, replace the module.	Very low
Incompatible sensor. Replace the SpO2 sensor. 041400	The adhesive SpO2 sensor is not recognized	Replace SpO2 sensor. If the problem is still present, replace the SpO2 cable. If the problem is still present, verify the module functionality by replacing the sensor with an applicable SpO2 tester. If the message persists, replace the module.	Very low
Replace the SpO2 sensor. 041500	The adhesive SpO2 sensor is defective	Replace SpO2 sensor. If the problem is still present, replace the SpO2 cable. If the problem is still present, verify the module functionality by replacing the sensor with an	Very low

Message	Possible cause	Suggested action	Alarm priority
		applicable SpO2 tester. If the message persists, replace the module.	
Searching for pulse signal. 041800	SpO2 pulse search	Pulse search is part of normal operation, and does not have an associated corrective action.	High
Low perfusion index. Clear to retry. 041a00	There is marginal SpO2 pulse quality or artifact.	Reapply the sensor to the patient. If the problem is still present, replace the SpO2 sensor. If the problem is still present, replace the cable. If the problem is still present, verify module functionality by replacing the sensor with an applicable SpO2 tester. If the message persists replace the module.	Very low
Demo mode active. 041b00	The SpO2 parameter is in demo mode	None. ¹	Very low
Sensor not connected. Clear to retry. 041c00	Check the SpO2 sensor connection	Check the sensor and cable connection. If the problem is still present, replace the SpO2 sensor. If the problem is still present, replace the cable. If the problem is still present, verify the module functionality by replacing the sensor with an applicable SpO2 tester. If the message persists replace the module.	Very low
SpO2 rebooting. 04ef00	There is an SpO2 raw queue overrun	A malfunction is detected. There are two possible causes of these failures. First, the power provided to the board is out of specification. In this case, the failure may be cleared once the underlying cause is removed. Second, the board has an actual hardware failure and recovery is not possible. It is recommended that the SpO2 module be replaced, and if problem is still present replace the monitor's main board.	Very low
SpO2 rebooting. 041f00	There is an SpO2 hardware failure	A malfunction is detected. There are two possible causes of these failures. First, the power provided to the board is out of specification. In this case, the failure may be cleared once the underlying cause is removed. Second, the board has an actual hardware failure and recovery is not possible. It is recommended that the SpO2 module be replaced, and if problem is still present replace the monitor's main board.	Very low
SpO2 rebooting. 042000	There is an SpO2 MCU failure	A malfunction is detected. There are two possible causes of these failures. First, the power provided to	Very low

Message	Possible cause	Suggested action	Alarm priority
		the board is out of specification. In this case, the failure may be cleared once the underlying cause is removed. Second, the board has an actual hardware failure and recovery is not possible. It is recommended that the SpO2 module be replaced, and if problem is still present replace the monitor's main board.	
SpO2 rebooting. 042100	There is an SpO2 watchdog failure	A malfunction is detected. There are two possible causes of these failures. First, the power provided to the board is out of specification. In this case, the failure may be cleared once the underlying cause is removed. Second, the board has an actual hardware failure and recovery is not possible. It is recommended that the SpO2 module be replaced, and if problem is still present replace the monitor's main board.	Very low
SpO2 not functional. 042200	There is an invalid SpO2 board type	A malfunction is detected. There are two possible causes of these failures. First, the power provided to the board is out of specification. In this case, the failure may be cleared once the underlying cause is removed. Second, the board has an actual hardware failure and recovery is not possible. It is recommended that the SpO2 module be replaced, and if problem is still present replace the monitor's main board.	Very low
SpO2 rebooting. 042300	There is an invalid SpO2 master control state	A malfunction is detected. There are two possible causes of these failures. First, the power provided to the board is out of specification. In this case, the failure may be cleared once the underlying cause is removed. Second, the board has an actual hardware failure and recovery is not possible. It is recommended that the SpO2 module be replaced, and if problem is still present replace the monitor's main board.	Very low
SpO2 rebooting. 042400	There is an SpO2 SRAM transfer failure	A malfunction is detected. There are two possible causes of these failures. First, the power provided to the board is out of specification. In this case, the failure may be cleared once the underlying cause is removed. Second, the board has an actual hardware failure and recovery is not possible. It is recommended that the SpO2 module be replaced, and if problem is still present replace the monitor's main board.	Very low

Message	Possible cause	Suggested action	Alarm priority
SpO2 rebooting. 042500	There is an SpO2 SRAM task queue overrun	A malfunction is detected. There are two possible causes of these failures. First, the power provided to the board is out of specification. In this case, the failure may be cleared once the underlying cause is removed. Second, the board has an actual hardware failure and recovery is not possible. It is recommended that the SpO2 module be replaced, and if problem is still present replace the monitor's main board.	Very low
SpO2 rebooting. 042600	There is an SpO2 database failure	A malfunction is detected. There are two possible causes of these failures. First, the power provided to the board is out of specification. In this case, the failure may be cleared once the underlying cause is removed. Second, the board has an actual hardware failure and recovery is not possible. It is recommended that the SpO2 module be replaced, and if problem is still present replace the monitor's main board.	Very low
SpO2 rebooting. 042700	There is an invalid SpO2 flash memory device	A malfunction is detected. There are two possible causes of these failures. First, the power provided to the board is out of specification. In this case, the failure may be cleared once the underlying cause is removed. Second, the board has an actual hardware failure and recovery is not possible. It is recommended that the SpO2 module be replaced, and if problem is still present replace the monitor's main board.	Very low
SpO2 rebooting. 042800	There is a problem with the SpO2 analog ground	A malfunction is detected. There are two possible causes of these failures. First, the power provided to the board is out of specification. In this case, the failure may be cleared once the underlying cause is removed. Second, the board has an actual hardware failure and recovery is not possible. It is recommended that the SpO2 module be replaced, and if problem is still present replace the monitor's main board.	Very low
SpO2 rebooting. 042900	There is a problem with the SpO2 digital ground	A malfunction is detected. There are two possible causes of these failures. First, the power provided to the board is out of specification. In this case, the failure may be cleared once the underlying cause is removed. Second, the board has an actual hardware failure and recovery is not possible. It is recommended	Very low

Message	Possible cause	Suggested action	Alarm priority
		that the Sp02 module be replaced, and if problem is still present replace the monitor's main board.	
Sp02 rebooting. 042a00	There is a problem with the Sp02 LED ground	A malfunction is detected. There are two possible causes of these failures. First, the power provided to the board is out of specification. In this case, the failure may be cleared once the underlying cause is removed. Second, the board has an actual hardware failure and recovery is not possible. It is recommended that the Sp02 module be replaced, and if problem is still present replace the monitor's main board.	Very low
Sp02 rebooting. 042b00	There is a problem with the Sp02 reference voltage	A malfunction is detected. There are two possible causes of these failures. First, the power provided to the board is out of specification. In this case, the failure may be cleared once the underlying cause is removed. Second, the board has an actual hardware failure and recovery is not possible. It is recommended that the Sp02 module be replaced, and if problem is still present replace the monitor's main board.	Very low
Sp02 rebooting. 042c00	There is a problem with the Sp02 DSP core voltage	A malfunction is detected. There are two possible causes of these failures. First, the power provided to the board is out of specification. In this case, the failure may be cleared once the underlying cause is removed. Second, the board has an actual hardware failure and recovery is not possible. It is recommended that the Sp02 module be replaced, and if problem is still present replace the monitor's main board.	Very low
Sp02 rebooting. 042d00	There is a problem with the Sp02 filtered input voltage	A malfunction is detected. There are two possible causes of these failures. First, the power provided to the board is out of specification. In this case, the failure may be cleared once the underlying cause is removed. Second, the board has an actual hardware failure and recovery is not possible. It is recommended that the Sp02 module be replaced, and if problem is still present replace the monitor's main board.	Very low
Sp02 rebooting. 042e00	There is a problem with the Sp02 DSP I/O voltage	A malfunction is detected. There are two possible causes of these failures. First, the power provided to the board is out of specification. In this case, the failure may be cleared once the underlying cause is	Very low

Message	Possible cause	Suggested action	Alarm priority
		removed. Second, the board has an actual hardware failure and recovery is not possible. It is recommended that the SpO2 module be replaced, and if problem is still present replace the monitor's main board.	
SpO2 rebooting. 042f00	There is a problem with the SpO2 positive detector voltage	A malfunction is detected. There are two possible causes of these failures. First, the power provided to the board is out of specification. In this case, the failure may be cleared once the underlying cause is removed. Second, the board has an actual hardware failure and recovery is not possible. It is recommended that the SpO2 module be replaced, and if problem is still present replace the monitor's main board.	Very low
SpO2 rebooting. 043000	There is a problem with the SpO2 negative detector voltage	A malfunction is detected. There are two possible causes of these failures. First, the power provided to the board is out of specification. In this case, the failure may be cleared once the underlying cause is removed. Second, the board has an actual hardware failure and recovery is not possible. It is recommended that the SpO2 module be replaced, and if problem is still present replace the monitor's main board.	Very low
SpO2 rebooting. 043100	There is a problem with the SpO2 positive LED Voltage	A malfunction is detected. There are two possible causes of these failures. First, the power provided to the board is out of specification. In this case, the failure may be cleared once the underlying cause is removed. Second, the board has an actual hardware failure and recovery is not possible. It is recommended that the SpO2 module be replaced, and if problem is still present replace the monitor's main board.	Very low
SpO2 rebooting. 043200	There is a problem with the SpO2 LED drive voltage	A malfunction is detected. There are two possible causes of these failures. First, the power provided to the board is out of specification. In this case, the failure may be cleared once the underlying cause is removed. Second, the board has an actual hardware failure and recovery is not possible. It is recommended that the SpO2 module be replaced, and if problem is still present replace the monitor's main board.	Very low
SpO2 rebooting. 043300	There is a problem with the SpO2 positive preamp voltage	A malfunction is detected. There are two possible causes of these failures. First, the power provided to	Very low

Message	Possible cause	Suggested action	Alarm priority
		the board is out of specification. In this case, the failure may be cleared once the underlying cause is removed. Second, the board has an actual hardware failure and recovery is not possible. It is recommended that the SpO2 module be replaced, and if problem is still present replace the monitor's main board.	
SpO2 rebooting. 043400	There is a problem with the SpO2 Sensor ID	A malfunction is detected. There are two possible causes of these failures. First, the power provided to the board is out of specification. In this case, the failure may be cleared once the underlying cause is removed. Second, the board has an actual hardware failure and recovery is not possible. It is recommended that the SpO2 module be replaced, and if problem is still present replace the monitor's main board.	Very low
SpO2 rebooting. 043500	There is a problem with the SpO2 thermistor	A malfunction is detected. There are two possible causes of these failures. First, the power provided to the board is out of specification. In this case, the failure may be cleared once the underlying cause is removed. Second, the board has an actual hardware failure and recovery is not possible. It is recommended that the SpO2 module be replaced, and if problem is still present replace the monitor's main board.	Very low
SpO2 rebooting. 043600	There is a problem with the SpO2 LED current	A malfunction is detected. There are two possible causes of these failures. First, the power provided to the board is out of specification. In this case, the failure may be cleared once the underlying cause is removed. Second, the board has an actual hardware failure and recovery is not possible. It is recommended that the SpO2 module be replaced, and if problem is still present replace the monitor's main board.	Very low
SpO2 rebooting. 043700	There is a problem with the SpO2 preamp	A malfunction is detected. There are two possible causes of these failures. First, the power provided to the board is out of specification. In this case, the failure may be cleared once the underlying cause is removed. Second, the board has an actual hardware failure and recovery is not possible. It is recommended that the SpO2 module be replaced, and if problem is still present replace the monitor's main board.	Very low

Message	Possible cause	Suggested action	Alarm priority
SpO2 rebooting. 044200	The SpO2 module received a bad packet	There is an internal software malfunction in the main PCBA. Update the software. If the problem persists, replace the module.	Very low
SpO2 rebooting. 044300	The SpO2 module received an invalid command	There is an internal software malfunction in the main PCBA. Update the software. If the problem persists, replace the module.	Very low
SpO2 rebooting. 044400	The SpO2 module received a command that would result in more output than the baud rate can support	There is an internal software malfunction in the main PCBA. Update the software. If the problem persists, replace the module.	Very low
SpO2 rebooting. 044500	The SpO2 module received a command that requires an application that is not present	There is an internal software malfunction in the main PCBA. Update the software. If the problem persists, replace the module.	Very low
SpO2 rebooting. 044600	The SpO2 module received a command while still locked	There is an internal software malfunction in the main PCBA. Update the software. If the problem persists, replace the module.	Very low

¹Demo mode is reported when you plug a Masimo demo tool into the patient cable connector. This tool simulates a patient being connected, and is only used in a development environment. Because this tool simulates a patient without a patient actually being connected, it should NEVER be present in a clinical setting.

Nellcor messages

Message	Possible cause	Suggested action	Alarm priority
Sensor not connected. Clear to retry. 043800	The SpO2 sensor is not connected	Connect SpO2 sensor. If the problem is still present, replace the SpO2 cable. If the problem is still present, verify the module functionality by replacing the sensor with an applicable SpO2 tester. If the message persists, replace the module.	Very low
Searching for pulse signal 043900	None	None ¹	High
SpO2 interference detected. Clear to retry. 043b00	SpO2 module interference detected.	Reapply the sensor to the patient. If the problem is still present, replace the SpO2 Ssensor. If the problem is still present, replace the cable. If the problem is still present, verify module functionality by replacing the sensor with an applicable SpO2 tester. If the message persists, replace the module.	Very low
SpO2 rebooting. 043c00	SpO2 module hardware error	A module hardware error is detected. Replace module.	Very low

Message	Possible cause	Suggested action	Alarm priority
SpO2 rebooting. 043d00	SpO2 module hardware error	A module hardware error is detected. Replace module.	Very low
SpO2 rebooting. 043e00	SpO2 module software error	A module hardware error is detected. Replace module.	Very low
SpO2 rebooting. 043f00	The SpO2 module received a bad message	This error indicates a bug in the main board software. Call for service.	Very low
Replace the SpO2 sensor. 044000	The SpO2 sensor is defective	Replace the SpO2 sensor. If the problem is still present, replace the SpO2 sensor. If the problem is still present, replace the cable. If the problem is still present, verify module functionality by replacing the sensor with an applicable SpO2 tester. If the message persists, replace the module.	Very low
SpO2 rebooting. 044100	The SpO2 module received a bad message	This error indicates a bug in the main board software. Call for service.	Very low

¹Pulse search is a normal part of operation and does not have an associated corrective action.

Nonin messages

Message	Possible cause	Suggested action	Alarm priority
Sensor not connected. Clear to retry. 040100	The SpO2 sensor is not connected	Connect SpO2 sensor, if the problem is still present, replace the SpO2 cable. If the problem is still present, verify the module functionality by replacing the sensor with an applicable SpO2 tester. If the message persists, replace the module.	Very low
Searching for pulse signal. 040200	None	None ¹	High
SpO2 interference detected. Clear to retry. 040400	The SpO2 interference detected.	Reapply the sensor to the patient. If the problem is still present, replace the SpO2 Sensor. If the problem is still present, replace the cable. If the problem is still present, verify module functionality by replacing the sensor with an applicable SpO2 tester. If the message persists, replace the module.	Very low
Low SpO2 perfusion index. Clear to retry. 040500	SpO2 marginal pulse quality or artifact	Reapply the sensor to the patient. If the problem is still present, replace the SpO2 Sensor. If the problem is still present, replace the cable. If the problem is still present, verify module functionality by replacing the sensor with an applicable SpO2	Very low

Message	Possible cause	Suggested action	Alarm priority
		tester. If the message persists, replace the module.	
¹ Pulse search is a normal part of operation and does not have an associated corrective action.			

Temperature messages

SureTemp messages

Message	Possible cause	Suggested action	Alarm priority
Temperature not functional. 30105	WACP message CRC mismatch on temperature module	Internal malfunction. If the problem persists, replace the module.	Very low
Temperature not functional. 30201	This message is not implemented by the temperature module	Internal malfunction. If the problem persists, replace the module.	Very low
Temperature not functional. 30202	This message is not supported by the temperature module	Internal malfunction. If the problem persists, replace the module.	Very low
Temperature not functional. 30203	The temperature module has run out of memory.	Internal malfunction. If the problem persists, replace the module.	Very low
Temperature not functional. 30205	The temperature module received a invalid parameter	Internal malfunction. If the problem persists, replace the module.	Very low
Temperature not functional. 30206	The parameter provided by the temperature module is outside of the allowable range for the specified message.	Internal malfunction. If the problem persists, replace the module.	Very low
Temperature not functional. 30207	The temperature module message requires an object, but did not contain one.	Internal malfunction. If the problem persists, replace the module.	Very low
Temperature not functional. 30208	The temperature module object provided with the message could not be deserialized.	Internal malfunction. If the problem persists, replace the module.	Very low
Temperature not functional. 30209	The temperature module object could not be serialized.	Internal malfunction. If the problem persists, replace the module.	Very low
Temperature not functional. 3020A	The temperature module message is performing a request/action when the	Internal malfunction. If the problem persists, replace the module.	Very low

Message	Possible cause	Suggested action	Alarm priority
	module state prohibits the request/action.		
Temperature not functional. 3020B	The temperature module requested item is not currently available due to the module state.	Internal malfunction. If the problem persists, replace the module.	Very low
Temperature not functional. 30503	The temperature module factory settings, and calibration information is corrupt.	Internal malfunction. If the problem persists, replace the module.	Very low
Temperature not functional. 30504	The temperature module user settings are corrupt.	Internal malfunction. If the problem persists, replace the module.	Very low
Temperature not functional. 30509	The temperature module calibration is not set.	Internal malfunction. If the problem persists, replace the module.	Very low
Temperature not functional. 3050C	The temperature module error log is corrupt.	Internal malfunction. If the problem persists, replace the module.	Very low
Temperature not functional. 30516	A hardware malfunction on the temperature module has been detected.	Internal malfunction. If the problem persists, replace the module.	Very low
Temperature not functional. 30518	The temperature module power rail is too low.	Internal malfunction. If the problem persists, replace the module.	Very low
Temperature not functional. 30519	The temperature module power rail is too high.	Internal malfunction. If the problem persists, replace the module.	Very low
Temperature not functional. 3051A	The temperature module reference voltage circuit was detected to be under voltage or unstable.	Internal malfunction. If the problem persists, replace the module.	Very low
Ambient temperature out of range. Clear to retry. 30801	The temperature module measurement is below the allowable temperature values and beyond the low ambient or patient limits.	Verify conditions are greater than 50 °F or 10 °C. If conditions are valid and the problem persists, replace the probe. If the problem still persists, replace the module.	Very low
Ambient temperature out of range. Clear to retry. 30802	The temperature module measurement is above the allowable temperature values and beyond the high	Verify conditions are less than 104 °F or 40 °C. If conditions are valid and the problem persists, replace the probe. If the problem still persists, replace the module.	Very low

Message	Possible cause	Suggested action	Alarm priority
	ambient or patient limits.		
Temperature not functional. 30803	The temperature module internal calibration resistor (RCAL) on the board is damaged or contaminated (pulse too long).	Internal malfunction. If the problem persists, replace the module.	Very low
Temperature not functional. 30804	The temperature module internal calibration resistor (RCAL) on the board is damaged or contaminated (pulse too short).	Internal malfunction. If the problem persists, replace the module.	Very low
Temperature not functional. 30805	The temperature module internal circuit validation resistor (PTB) on the board is damaged (value is over).	Internal malfunction. If the problem persists, replace the module.	Very low
Temperature not functional. 30806	The temperature module internal circuit validation resistor (PTB) on the board is damaged (value is under).	Internal malfunction. If the problem persists, replace the module.	Very low
Ambient temperature out of range. Clear to retry. 30807	The temperature module A/D measurement timed out	Verify conditions are greater than 50 °F or 10 °C. If conditions are valid and the problem persists, replace the probe. If the problem still persists, replace the module.	Very low
Replace temperature probe. 30808	The temperature module probe was not characterized/calibrated	Probe malfunction. Replace the probe. If the problem persists, replace the module.	Very low
Insert correct color-coded probe well. 30809	The temperature module is missing the probe well	Insert the probe well	Very low
Temperature not functional. 3080A	The temperature module has a problem saving to the monitor EEPROM in biotech mode	Internal malfunction. If the problem persists, replace the module.	Very low
Temperature not functional. 3080B	The temperature module error detection mechanism detected an error	Internal malfunction. If the problem persists, replace the module.	Very low
Replace temperature probe. 3080C	The temperature module probe error	Probe malfunction. Replace probe. If the problem persists, replace the module.	Very low

Message	Possible cause	Suggested action	Alarm priority
	detection mechanism detected an error		
Temperature not functional. 3080D	The temperature module log error detection mechanism detected an error	Probe malfunction. Replace probe. If the problem persists, replace the module.	Very low
Temperature not functional. 3080E	The temperature module calibration error detection mechanism detected an error	Probe malfunction. Replace probe. If the problem persists, replace the module.	Very low
Connect temperature probe. 3080F	The temperature module detected no probe connected	Probe malfunction. Replace probe. If the problem persists, replace the module.	Very low
Replace temperature probe. 30810	The temperature module cannot read the probe EEPROM correctly or the probe left the factory without being tested.	Probe malfunction. Replace probe. If the problem persists, replace the module.	Very low
Temperature not functional. 30811	The temperature module has an invalid events index	Internal malfunction. If the problem persists, replace the module.	Very low
Temperature not functional. 30812	There is a problem reading the temperature module EEPROM or saving to the monitor EEPROM in biotech mode.	Internal malfunction. If the problem persists, replace the module.	Very low
Replace temperature probe. Code 30813	The temperature module has a problem reading the probe EEPROM.	Probe malfunction. Replace probe. If the problem persists, replace the module.	Very low
Temperature not functional. 30814	The temperature module TEMP CONFIG ACQUIRE FAILURE	Internal malfunction. If the problem persists, replace the module.	Very low
Temperature not functional. 30815	The temperature module TEMP CONFIG RELEASE FAILURE	Internal malfunction. If the problem persists, replace the module.	Very low
Temperature not functional. 30816	The temperature module TEMP CONFIG INVALID PTR FAILURE	Internal malfunction. If the problem persists, replace the module.	Very low
Temperature not functional. 30817	The temperature module internal error. EEPROM not initialized	Internal malfunction. If the problem persists, replace the module.	Very low
Unable to detect new temperature. Retry measurement. 30818	The temperature module heater	Probe malfunction. Replace probe. If the problem persists, replace the module.	Very low

Message	Possible cause	Suggested action	Alarm priority
	indicates on when turned off.		
Unable to detect new temperature. Retry measurement. 30819	The temperature module heater indicates off when turned on.	Probe malfunction. Replace probe. If the problem persists, replace the module.	Very low
Temperature not functional. 3081A	The temperature module HTR_Q is on and HTRC is off but still has voltage.	Internal malfunction. If the problem persists, replace the module.	Very low
Temperature not functional. 3081B	The temperature module HTR_Q is tri-stated with HTRC enabled and has heater power.	Internal malfunction. If the problem persists, replace the module.	Very low
Temperature not functional. 3081C	The temperature module turned Q&C on and the heater voltage is not high enough.	Internal malfunction. If the problem persists, replace the module.	Very low
Temperature not functional. 3081D	The temperature module heater hardware failsafe should have turned off but did not.	Internal malfunction. If the problem persists, replace the module.	Very low
Replace temperature probe. 3081E	The temperature module probe is above 112°F or 43.3°C.	Probe malfunction. Replace probe. If the problem persists, replace the module.	Very low
Replace temperature probe. 3081F	The temperature module has excessive heater energy	Probe malfunction. Replace probe. If the problem persists, replace the module.	Very low
Temperature not functional. 30820	The temperature module host interface error	Internal malfunction. If the problem persists, replace the module.	Very low
Ambient temperature out of range. Clear to retry. 30821	The temperature module over ambient 45 °C temp	Verify conditions are less than 104 °F or 40 °C. If conditions are valid and the problem persists, replace the probe. If the problem still persists, replace the module.	Very low
Ambient temperature out of range. Clear to retry. 30822	The temperature module under ambient temp	Verify conditions are greater than 50 F or 10°C. If conditions are valid and the problem persists, replace the probe. If the problem still persists, replace the module.	Very low
Temperature not functional. 30823	The temperature module has an invalid SureTemp algorithm	Internal malfunction. If the problem persists, replace the module.	Very low
Temperature not functional. 30824	The temperature module is over max battery volts	Internal malfunction. If the problem persists, replace the module.	Very low

Message	Possible cause	Suggested action	Alarm priority
Temperature not functional. 30825	The temperature module is under min battery volts	Internal malfunction. If the problem persists, replace the module.	Very low
Temperature not functional. 30826	The temperature module battery volts not set	Internal malfunction. If the problem persists, replace the module.	Very low
Temperature not functional. 30827	The temperature module predict algorithm is not set	Internal malfunction. If the problem persists, replace the module.	Very low
Temperature not functional. 30828	The temperature module ambient temp is not set	Internal malfunction. If the problem persists, replace the module.	Very low
Temperature not functional. 30829	The temperature module has a non-responsive probe. The thermistor has pulled away from the tip or the heater is broken.	Probe malfunction. Replace probe. If the problem persists, replace the module.	Very low
Temperature not functional. 3082A	The temperature module is experiencing bad probe gain	Probe malfunction. Replace probe. If the problem persists, replace the module.	Very low
Temperature not functional. 3082B	The temperature module has a bad probe response value	Probe malfunction. Replace probe. If the problem persists, replace the module.	Very low
Temperature not functional. 03C800	The temperature module is not functional	Internal malfunction. If the problem persists, replace the module.	Very low
Temperature not functional. 03C900	Unable to deserialize messages from the temperature module	Internal malfunction. If the problem persists, replace the module.	Very low
Temperature not functional. 03CA00	Unsupported message received from the Temperature module	Internal malfunction. If the problem persists, replace the module.	Very low
Temperature not functional. 03CB00	Unable to send message to the Temperature module	Internal malfunction. If the problem persists, replace the module.	Very low
Temperature not functional. 03CC00	Temperature module communication times out	Internal malfunction. If the problem persists, replace the module.	Very low
Temperature not functional. 03CD00	Failed to upgrade the temperature module	Internal malfunction. If the problem persists, replace the module.	Very low
Temperature not functional. 03CE00	Unable to read PIM file	Retry the device update.	Very low

Message	Possible cause	Suggested action	Alarm priority
Temperature not functional. 03CE01	Upgrade file directory could not be accessed	Retry the device update	Very low
Direct mode reading timed out	Direct mode reading times out	Direction mode reading times out	Information
Tissue contact lost.	Lost tissue contact while attempting to acquire a temperature measurement or acquired measurement was performed with limited tissue contact.	Check the tissue contact and try the measurement again.	Information
Temperature module reset. 03D000	Temperature sensor reset unexpectedly	None	Very low

Braun 6000 messages

Message	Possible cause	Suggested action	Alarm priority
Temperature not functional. 3F0105	WACP message CRC mismatch.	Internal malfunction. If the problem persists, replace the module.	Very low
Temperature not functional. 3F0201	This message is not implemented by the module.	Internal malfunction. If the problem persists, replace the module.	Very low
Temperature not functional. 3F0202	This message is not supported by the module.	Internal malfunction. If the problem persists, replace the module.	Very low
Temperature not functional. 3F0203	The module has run out of memory.	Internal malfunction. If the problem persists, replace the module.	Very low
Temperature not functional. 3F0204	No parameter provided for the specified message.	Internal malfunction. If the problem persists, replace the module.	Very low
Temperature not functional. 3F0205	The parameter provided is invalid for the specified message.	Internal malfunction. If the problem persists, replace the module.	Very low
Temperature not functional. 3F0206	The parameter provided is outside of the allowable range for the specified message.	Internal malfunction. If the problem persists, replace the module.	Very low
Temperature not functional. 3F0207	The message requires an object, but did not contain one.	Internal malfunction. If the problem persists, replace the module.	Very low

Message	Possible cause	Suggested action	Alarm priority
Temperature not functional. 3F0208	The object provided with the message could not be deserialized.	Internal malfunction. If the problem persists, replace the module.	Very low
Temperature not functional. 3F0209	The object could not be serialized.	Internal malfunction. If the problem persists, replace the module.	Very low
Temperature not functional. 3F020A	The message is performing a request/action when the module state prohibits the request/action.	Internal malfunction. If the problem persists, replace the module.	Very low
Temperature not functional. 3F020B	The requested item is not currently available due to the module state.	Internal malfunction. If the problem persists, replace the module.	Very low
Temperature not functional. 3F0503	The factory settings, and calibration information is corrupt.	Internal malfunction. If the problem persists, replace the module.	Very low
Temperature not functional. 3F0504	The user settings are corrupt.	Internal malfunction. If the problem persists, replace the module.	Very low
Temperature not functional. 3F0509	The calibration is not set.	Internal malfunction. If the problem persists, replace the module.	Very low
Temperature not functional. 3F050C	The error log is corrupt.	Internal malfunction. If the problem persists, replace the module.	Very low
Temperature not functional. 3F0516	A hardware malfunction has been detected	Internal malfunction. If the problem persists, replace the module.	Very low
Temperature not functional. 3F0518	The module power rail is too low.	Internal malfunction. If the problem persists, replace the module.	Very low
Temperature not functional. 3F0519	The module power rail is too high.	Internal malfunction. If the problem persists, replace the module.	Very low
Temperature not functional. 3F051A	The reference voltage circuit was detected to be under voltage or unstable.	Internal malfunction. If the problem persists, replace the module.	Very low
Temperature not functional. 3F0821	The ambient temperature is too high	Verify conditions are less than 104°F or 40°C. If conditions are valid and the problem persists, replace the probe. If the problem still persists, replace the module.	Very low
Temperature not functional. 3F0822	The ambient temperature is too low	Verify conditions are greater than 50°F or 10°C. If conditions are valid and problem persists, replace the probe. If the problem still persists, replace the module.	Very low

Message	Possible cause	Suggested action	Alarm priority
Temperature not functional. 3F0824	The battery is over the maximum voltage	Internal malfunction. If the problem persists, replace the module.	Very low
Temperature not functional. 3F0833	The sensor not functional	Internal malfunction. If the problem persists, replace the module.	Very low
Temperature not functional. 3F0E04	Low battery	Recharge the battery. If the problem persists, check the battery.	Very low
Unable to detect new temperature. Retry measurement.	No temperature measurement was available from the thermometer at the time it was docked.	If a measurement should have been available, retry the measurement. If problem the persists, replace the module.	Information
Thermometer might be docked improperly. Check contacts and connections.	Communication failure with docked Braun	The thermometer might be docked improperly. Check contacts and connections. If problem the persists, replace the module.	Information
Temperature not functional. 3FFF01	Unrecognized WACP parameter received from sensor	Internal malfunction. If the problem persists, replace the module.	Very low
Temperature not functional. 3FFF02	Timeout waiting for sensor response	Internal malfunction. If the problem persists, replace the module.	Very low
Temperature not functional. 3FFF03	Error deserializing WACP message received from sensor	Internal malfunction. If the problem persists, replace the module.	Very low
Temperature not functional. 3FFF04	WACP stack send message failure	Internal malfunction. If the problem persists, replace the module.	Very low
Re-dock Braun. 3FFF05	Anti-theft timer expired	Re-dock the thermometer after taking a measurement.	Very low

Patient and clinician data messages

Message	Possible cause	Suggested action	Alarm priority
Unable to identify clinician. No provider configured at host.	Clinician authentication failure	Information status message; press OK button to dismiss.	Information
Unable to identify clinician. Security provider error.	Clinician authentication failure	Information status message; press OK button to dismiss.	Information
Unable to identify clinician. User not found.	Clinician authentication failure	Information status message; press OK button to dismiss.	Information

Message	Possible cause	Suggested action	Alarm priority
Unable to identify clinician. Invalid ID or system password.	Clinician authentication failure	Information status message; press OK button to dismiss.	Information
Unable to identify clinician. Account disabled/expired.	Clinician authentication failure	Information status message; press OK button to dismiss.	Information
Unable to identify clinician. Password expired/reset required.	Clinician authentication failure	Information status message; press OK button to dismiss.	Information
Unable to identify clinician. Group membership error.	Clinician authentication failure	Information status message; press OK button to dismiss.	Information
Unable to identify clinician. Touch Clear to delete all data.	Clinician authentication failure	Information status message; press OK button to dismiss.	Information
Unable to identify patient. Touch Clear to delete all data.	Patient authentication failure	Information status message; press OK button to dismiss.	Information
Database schema out of data; recreating.	The database was cleared due to a schema update	Information status message; press OK button to dismiss.	Information
Database is unreadable during startup; recreating. 1F0001	The database was unreadable during startup	Press OK button to dismiss.	Very low
Error accessing PDM database; restarting PDM. 1F0002	Database corrupted when device is in operation	Press OK button to dismiss.	Very low
Maximum number of patient records + Oldest record overwritten.	Data was deleted as it contained more than 400 records	Information status message; press OK button to dismiss.	Information
No data saved.	A manual save is not allowed	Information status message; press OK button to dismiss.	Information
Save successful.	A manual record was saved	Information status message; press OK button to dismiss.	Information
Patient ID required to save data.	A Patient ID is required to save data	Information status message; press OK button to dismiss.	Information
Patient ID required to start intervals.	A Patient ID is required to start intervals	Information status message; press OK button to dismiss.	Information
Clinician ID required to save data.	A Clinician ID is required to save data	Information status message; press OK button to dismiss.	Information

Message	Possible cause	Suggested action	Alarm priority
Clinician ID required to start intervals.	A Clinician ID is required to start intervals	Information status message; press OK button to dismiss.	Information
Patient ID match required to save data.	A Patient ID match is required to save data	N/A	Information
Patient ID match required to start intervals.	A Patient ID match is required to start intervals	N/A	Information
Clinician ID match required to save data.	A Clinician ID match is required to save data	N/A	Information
Clinician ID match required to start intervals.	A Clinician ID match is required to start intervals	N/A	Information
Unable to auto save.	The device was unable to auto save	Information status message; press OK button to dismiss.	Information
Barcode scan not accepted.	Barcode scanning is not available	Information status message; press OK button to dismiss.	Information
Invalid NIBP interval parameter during interval capture.	An invalid interval parameter was detected.	Information status message; press OK button to dismiss.	Information
Save successful.	The auto save is successful in Office Profile	Information status message; press OK button to dismiss.	Information
Unsent records: N of M	There are unsent records waiting when the device is powered down	Information status message; press OK button to dismiss.	Information
Barcode scanning is not available. Enter patient information manually.	Barcode scanning is not available. Enter patient information manually.	Information status message; press OK button to dismiss.	Information
Invalid SpO2 interval parameter during interval capture.	An invalid interval parameter was detected.	If SpO2 intervals are enabled and SpO2 clip was removed, either stop the intervals or reattach the SpO2 clip. Information status message; press OK button to dismiss.	Information

Radio messages

Message	Possible cause	Suggested action	Alarm priority
Radio not functional. 350001	Deserialization failure. There is a software communication issue between the host and the radio	Check for a software update and apply it. If still present, replace the radio.	Very low

Message	Possible cause	Suggested action	Alarm priority
Radio not functional. 350002	Permissions. There is an internal software error on the radio	Check for a software update and apply it. If still present, replace the radio.	Very low
Radio not functional. 350003	Unsupported operating system. There is an internal software error on the radio	Check for a software update and apply it. If still present, replace the radio.	Very low
Radio not functional. 350004	Unknown. There is an internal software error on the radio	Check for a software update and apply it. If still present, replace the radio.	Very low
Radio not functional. 350006	Invalid authentication. There is an internal software error on the radio	Check for a software update and apply it. If still present, replace the radio.	Very low
Radio not functional. 350008	Unknown SDC Error. There is an internal software error on the radio	Check for a software update and apply it. If still present, replace the radio.	Very low
Radio not functional. 350009	Invalid SDC configuration. There is an internal software error on the radio	Check for a software update and apply it. If still present, replace the radio.	Very low
Radio not functional. 35000a	Invalid SDC profile. There is an internal software error on the radio	Check for a software update and apply it. If still present, replace the radio.	Very low
Invalid radio configuration. Reconfigure and try again. 35000b	Invalid SDC WEP type. There is an internal software error on the monitor. Attempt to configure settings that don't apply in current authentication mode on radio	Check the radio configuration. If the problem is still present, reset the radio to factory defaults. If the problem persists, check for software update and apply it. If still present, replace the radio.	Very low
Invalid radio configuration. Reconfigure and try again. 35000c	Invalid SDC EAP type. There is an internal software error on the monitor: attempt to configure settings that don't apply in current authentication mode on radio	Check the radio configuration. If the problem is still present, reset the radio to factory defaults. If the problem persists, check for software update and apply it. If still present, replace the radio.	Very low
Invalid radio configuration. Reconfigure and try again. 35000d	Invalid SDC parameter. The Laird SDK rejects a parameter being configured.	Check the radio configuration. If the problem is still present, reset the radio to factory defaults. If the problem persists, check for software update and apply it. If still present, replace the radio.	Very low
Radio not functional. 35000e	Unrecognized. There is a version compatibility error if the radio or the monitor adds new features and software upgrade of the radio fails after the monitor successfully updates	Check for a software update and apply it. If still present, replace the radio.	Very low
Radio not functional. 35000f	No statistics file. There is an internal software error on the radio indicating a Linux kernel error	Check for a software update and apply it. If still present, replace the radio.	Very low

Message	Possible cause	Suggested action	Alarm priority
Radio not functional. 350010	Missing interface. There is an internal software error on the radio indicating a Linux kernel error or failure to initialize the network interface	Check for a software update and apply it. If still present, replace the radio.	Very low
Radio not functional. 350011	Unknown interface. There is a software communication issue between the host and the radio	Check for a software update and apply it. If still present, replace the radio.	Very low
Invalid radio configuration. Reconfigure and try again. 350012	Invalid WEP key length. WEP keys should be 10 or 26 characters long.	Check the radio configuration. If the problem is still present, reset the radio to factory defaults. If the problem persists, check for software update and apply it. If still present, replace the radio.	Very low
Invalid radio configuration. Reconfigure and try again. 350013	Not in EAP mode. There is an internal software error on the monitor: attempt to configure settings that don't apply in current authentication mode on radio	Check the radio configuration. If the problem is still present, reset the radio to factory defaults. If the problem persists, check for software update and apply it. If still present, replace the radio.	Very low
Invalid radio configuration. Reconfigure and try again. 350014	Invalid inner EAP method. There is an internal software error on the monitor: attempt to configure settings that don't apply in current authentication mode on radio	Check the radio configuration. If the problem is still present, reset the radio to factory defaults. If the problem persists, check for software update and apply it. If still present, replace the radio.	Very low
Radio not functional. 350015	Out of memory. There is an internal software error on the radio	Check for a software update and apply it. If still present, replace the radio.	Very low
Radio not functional. 350016	Invalid log level. There is a software communication issue on the radio	Check for a software update and apply it. If still present, replace the radio.	Very low
Radio not functional. 350017	Certificate path too long. There is an internal software error on the radio. The radio has a fixed path length	Check for a software update and apply it. If still present, replace the radio.	Very low
Invalid radio configuration. Reconfigure and try again. 350018	Missing client certificate. The radio attempted to configure for an EAP mode that requires a client certificate and no certificate is installed	Check the radio configuration. If the problem is still present, reset the radio to factory defaults. If the problem persists, check for software update and apply it. If still present, replace the radio.	Very low
Invalid radio configuration. Reconfigure and try again. 350019	Missing CA certification. The radio attempted to enable server validation and CA certification is missing	Check the radio configuration. If the problem is still present, reset the radio to factory defaults. If the problem persists, check for software update and apply it. If still present, replace the radio.	Very low
Radio not functional. 35001e	MAC request failed. There is an internal software error on the radio indicating a Linux kernel error or a failure to initialize the network interface	Check for a software update and apply it. If still present, replace the radio.	Very low

Message	Possible cause	Suggested action	Alarm priority
Radio not functional. 35001f	Invalid power mode. There is an internal software error on the radio	Check for a software update and apply it. If still present, replace the radio.	Very low
Radio not functional. 350020	Post results missing. There is an internal software error on the radio	Check for a software update and apply it. If still present, replace the radio.	Very low
Radio not functional. 350021	Post results format. There is an internal software error on the radio	Check for a software update and apply it. If still present, replace the radio.	Very low
Radio not functional. 350025	Unrecognized component. There is a version compatibility error if the radio or the monitor adds new features and software upgrade of the radio fails after the monitor successfully updates	Check for a software update and apply it. If still present, replace the radio.	Very low
Radio not functional. 350027	Missing release file. There is an internal software error on the radio with a missing file	Check for a software update and apply it. If still present, replace the radio.	Very low
Radio not functional. 350028	Not ready. Displays when logging verbosity is turned on	Check for a software update and apply it. If still present, replace the radio.	Very low
Radio not functional. 350029	Disconnected. There is a software communication issue between the host and the radio. Socket connection is down	Check for a software update and apply it. If still present, replace the radio.	Very low
Invalid radio configuration. Reconfigure and try again. 35002a	Invalid parameter. There is a software issue on the monitor while trying to configure radio	Check the radio configuration. If the problem is still present, reset the radio to factory defaults. If the problem persists, check for software update and apply it. If still present, replace the radio.	Very low
Radio not functional. 35002b	Timeout. There is a software communication issue between the host and the radio	Check for a software update and apply it. If still present, replace the radio.	Very low
Radio not functional. 35002c	Socket error. There is a software communication issue between the host and the radio	Check for a software update and apply it. If still present, replace the radio.	Very low
Radio not functional. 35002e	Cannot parse DHCP lease. There is an internal software error on the radio (error reading and converting DHCP lease file)	Check for a software update and apply it. If still present, replace the radio.	Very low
Invalid radio configuration. Reconfigure and try again. 350032	Invalid certificate password. The radio is misconfigured with a password that does not match the certificate.	Check the radio configuration. If the problem is still present, reset the radio to factory defaults. If the problem persists, check for software update and apply it. If still present, replace the radio.	Very low

Message	Possible cause	Suggested action	Alarm priority
Radio not functional. 350033	Serialization failure. There is an internal software error on the radio or the monitor	Check for a software update and apply it. If still present, replace the radio.	Very low
Radio not functional. 350034	Missing PAC file. There is a misconfiguration of the radio (configured for EAP-FAST and manual PAC but none supplied)	Check the radio configuration. If the problem is still present, reset the radio to factory defaults. If the problem persists, check for software update and apply it. If still present, replace the radio.	Very low
Invalid radio configuration. Reconfigure and try again. 350035	Invalid PAC file password. There is a misconfiguration of the radio (configured for EAP-FAST and manual PAC but password for PAC is incorrect)	Check the radio configuration. If the problem is still present, reset the radio to factory defaults. If the problem persists, check for software update and apply it. If still present, replace the radio.	Very low
Radio not functional. 350036	Invalid BSSID format. There was an internal software error on the radio (related to AP scan feature, may not occur with current Laird software)	Check for a software update and apply it. If still present, replace the radio.	Very low
Radio not functional. 350037	Unknown certificate ID. There is an internal software error on the monitor: attempt to query a certificate status for a certificate that does not exist	Check the radio configuration. If the problem is still present, reset the radio to factory defaults. If the problem persists, check for software update and apply it. If still present, replace the radio.	Very low
Radio not functional. 350038	Certificate information absent. The device queries certificate status for a certificate that isn't installed on the radio.	Check the radio configuration. If the problem is still present, reset the radio to factory defaults. If the problem persists, check for software update and apply it. If still present, replace the radio.	Very low
Radio not functional. 350039	Invalid sequence number. The device queries certificate status fragment that does not exist.	Check the radio configuration. If the problem is still present, reset the radio to factory defaults. If the problem persists, check for software update and apply it. If still present, replace the radio.	Very low
Invalid radio configuration. Reconfigure and try again. 35003c	CCKM not allowed. There is an attempt to use CCKM when not in WPA-Personal or WPA2-Enterprise modes	Check the radio configuration. If the problem is still present, reset the radio to factory defaults. If the problem persists, check for software update and apply it. If still present, replace the radio.	Very low
Radio not functional. 35003d	Send failure. The radio failed to send a message to the host	Check for a software update and apply it. If still present, replace the radio.	Very low
Radio not functional. 35003e	Unable to store global configuration settings to the backup file	Check for a software update and apply it. If still present, replace the radio.	Very low
Radio not functional. 35003f	Configuration hookup. There is an internal software error on the radio	Check for a software update and apply it. If still present, replace the radio.	Very low

Message	Possible cause	Suggested action	Alarm priority
Radio not functional. 350041	Unable to configure DHCP 60 on the radio	Check the radio configuration. If the problem is still present, reset the radio to factory defaults. If the problem persists, check for software update and apply it. If still present, replace the radio.	Very low
Radio not functional. 350042	DHCP option corrupt. The DHCP option file is not in the expected format	Check for a software update and apply it. If still present, replace the radio.	Very low
Radio not functional. 350043	Cannot delete file. There is an internal software error on the radio (occurs for Option 60 upload and factory default)	Check for a software update and apply it. If still present, replace the radio.	Very low
Radio not functional. 350046	Invalid SDC value. There is a software issue on the when trying to configure the radio.	Check for a software update and apply it. If still present, replace the radio.	Very low
Unable to establish network communications. Radio out of network range. 350100	No IP address after 30 seconds. Unable to associate.	Check ESSID and radio mode settings.	Very low
Invalid radio configuration. Reconfigure and try again. 350200	No IP address after 30 seconds. Unable to authenticate	Check radio security settings.	Very low
Radio card DHCP timeout. 350300	No IP address after 30 seconds. Unable to obtain DHCP address.	Check DHCP server settings.	Very low
Lost network communications. Radio out of network range. 350400	Radio lost association	Ensure the access point is still powered on and in range.	Very low
Radio not functional. 350500	POST failure	Power cycle the device and re-enable the radio. If the problem persists, replace the radio.	Very low
Radio software upgrade failed. 350600	The radio software upgrade failed.	Restart the monitor.	Information
Certificate load successful.	The radio customer certificate was successfully loaded from the host	None.	Information
Certificate load failed.	The radio customer certificate was not loaded	Try again.	Information

Connectivity messages

Message	Possible cause	Suggested action	Alarm priority
Unable to obtain wired device IP address. 210000	No wired connection	Verify DHCP functionality and configuration.	Very low
Network not found; check network cable connection. 210100	Lost ethernet DHCP address	Check wired connection into device then verify DHCP functionality and configuration.	Very low
Unable to communicate with NRS. 360000	Cannot communicate with NRS	Verify NRS IP configuration and functionality.	Very low
Communication error with host. 1A0000	Communication timeout failure with external Host	Verify the external host services are loaded and started on the server. If the problem persists, check for available software upgrades of the monitor or the system.	Very low
Data rejected. CRC mismatch. 1A0001	The WACP stack has detected a CRC mismatch in the message	Check the data and try again. If the problem persists, contact your system administrator.	Very low
Data rejected. Unsupported message. 1A0002	External Host NACK - The host does not support the message/object.	Check the monitor and try again. If the problem persists, contact your system administrator.	Very low
Data rejected. Invalid parameter. 1A0003	The message has an invalid parameter.	Check the data and try again. If the problem persists, contact your system administrator.	Very low
Data rejected. Deserialize the object. 1A0004	The monitor failed to deserialize the object.	Check the data and try again. If the problem persists, contact your system administrator.	Very low
Data rejected. Unsupported message. 1A0005	The host is in a state that cannot accept the message.	Check the data and try again. If the problem persists, contact your system administrator.	Very low
Data rejected. Patient ID required. 1A0006	The message has a missing patient ID	Add the patient ID to the record.	Very low
Data rejected. Clinician ID required. 1A0007	The message is missing a clinician ID	Add the clinician ID to the record.	Very low
Data rejected. Time mismatch. 1A0008	The message has a mismatched time	Ensure that the clock on the monitor and the server match.	Very low
Unable to establish network communications. 1A0009	No network connection is available	Connect the device to an active network so that the clinician ID can be imported.	Very low
No connection for send.	No connection for send.	None	Information
Send not successful.	Send not successful.	None	Information

Message	Possible cause	Suggested action	Alarm priority
Error in record. Try again	Connectivity NACK received for NRS/ECS/CS/NCE	NRS/ECS/CS/NCE NACK that is record specific and can be fixed by a clinician in the next record	Information
Send successful.	Data was successfully sent over USB/BT	None	Information

System messages

Message	Possible cause	Suggested action	Alarm priority
000001	System failure	Restart the monitor	N/A
000002	System failure	Restart the monitor	N/A
000003	System failure	Restart the monitor	N/A
000004	System failure	Restart the monitor	N/A
000005	System failure	Restart the monitor	N/A
000006	System failure	Restart the monitor	N/A
Internal hardware failure.	The root file system is corrupted; restart not possible	Restart the monitor. If the problem persists, replace the main PCBA.	N/A
Internal hardware failure. 140100	EEPROM access failed. The device boot is possible, but wired communications are disabled	Reprogram the EEPROM. If the problem persists replace the main PCBA.	Very low
Internal hardware failure.	SPL memory test failure, the monitor will sound an SOS pattern	Restart the monitor. If the problem persists, replace the main PCBA.	N/A
Internal hardware failure. 1C1000	The monitor PIC communications never starts or quits. The communication won't reasonably recover at startup or during operation	Restart the monitor. If the problem persists, replace the main PCBA.	N/A
Low battery 30 minutes or less remaining. 1C1005	The battery power is low	Connect the power supply to AC power to charge the monitor.	Very low
Low battery 5 minutes or less remaining. 1C1006	The battery power is extremely low	Connect the power supply to AC power to charge the monitor.	High
Battery is critically low; plug into outlet. Device is shutting down. 1C1007	The battery power is critically low	Connect the power supply to AC power to charge the monitor.	High

Message	Possible cause	Suggested action	Alarm priority
Update unsuccessful. Reboot and retry. 1C1008	The software update failed	Restart the monitor. If the problem is still present, replace the main PCBA.	Very low
Host battery not charging. 1C100A	The host battery is not charging	Restart the monitor. If the problem is still present, check cable connections. If the problem is still present, perform functional checks for host. If the problem is still present, replace battery. If the problem persists, replace the main PCBA.	Very low
Factory default settings now active. 3A0001	The factory configuration settings are active	The monitor has been configured to factory defaults, any user settings have been reset.	Very low
Unable to read configuration from USB. 3A0002	Unable to load file from the external USB memory device.	Retry the USB connection. If the problem is still present, check for a proper format of the USB drive. If the problem is still present, replace the USB device. If the problem persists, replace the main PCBA.	Very low
Internal hardware failure. Device will shut down. 1C100D	Power supply issue. The PMIC is too hot	Check the operating environment temperature. Allow the monitor to cool down before operating again. If the problem is still present, check the cable connections. If the problem is still present, perform functional checks for host. If the problem is still present, replace the battery. If the problem is still present, replace the main PCBA.	Very low
Input voltage too low. Device will shut down. 1C100C	Power supply issue. The PMIC input voltage is too low	Check the operating environment temperature. Allow the monitor to cool down before operating again. If the problem is still present, check the cable connections. If the problem is still present, perform functional checks for host. If the problem is still present, replace the battery. If the problem is still present, replace the main PCBA.	Very low
Unexpected restart occurred. 1C1012	The monitor unexpectedly restarted	Continue normal operation	High
Audio system not functional 1D0100	The speaker or audio codec is faulty	Replace speaker. If the problem is still present, replace the main PCBA.	Very low
CSM battery is not installed. 1C100E	There is no battery in the monitor	Check the monitor for a battery and install one if it is missing. If the problem is still present, perform diagnostic checks on the monitor. If the problem persists, replace the main PCBA.	Very low
Device shutdown is not available at this time	System shutdown failure	Monitor cannot perform an immediate shutdown. Disconnect AC power and remove battery.	Information
No valid files found	No valid files were found on the USB flash drive	Re-insert the USB flash drive with valid files.	Information

Message	Possible cause	Suggested action	Alarm priority
Firmware update successful.	The software successfully updated	Information status message; press OK button to dismiss.	Information
Audio alarms are off.	The monitor alarm audio is off	Information status message; press OK button to dismiss.	Information
Advanced settings unavailable.	The advanced settings are unavailable because the monitor is not in an idle state	Confirm that no sensors are attached to the monitor, no alarms are active, and there is no unsaved data in the Spot or Intervals profile.	Information
USB accessory disconnected.	The USB device was disconnected from the monitor	Information status message; press OK button to dismiss	Information
Advanced settings	The Advanced settings code was entered correctly	Information status message; Exit Advanced settings to dismiss.	Information
Save not successful.	The device configuration or logs were not saved to the USB device	Information status message; press OK button to dismiss	Information
Save successful.	The device configuration or logs were saved to the USB device	Information status message; press OK button to dismiss	Information
Software upgrade is downloading. Do not shutdown.	Cannot power down device as software install is in progress	N/A	Information
Factory reset successful.	The monitor was reset to factory settings	Information status message; press OK button to dismiss	Information
Factory reset failed. Custom configuration file not deleted.	The monitor factory reset has failed.	Information status message; Exit Advanced settings to dismiss.	Information
Configuration upload successful.	The device configuration has successfully uploaded	Information status message; press OK button to dismiss	Information
Unable to load configuration.	The device configuration was not successfully uploaded	N/A	Information

Software update messages

Message	Possible cause	Suggested action	Alarm priority
Software Update: Manifest transfer timed out. Verify connection and retry.	The manifest file transfer timed out or connection was lost during download	Verify the connection and retry.	Information
Software Update: Package file transfer timed out. Verify connection and retry	The package file transfer timed out or connection was lost during download	Verify the connection and retry.	Information

Message	Possible cause	Suggested action	Alarm priority
Software Update: Invalid token file.	There was an invalid token file	Verify and update the token file.	Information
Software Update: Unable to find manifest file on server.	The manifest file was not found on the server	Verify the manifest file is on the server.	Information
Software Update: Unable to verify manifest file signature.	The manifest file signature verification failed.	Regenerate the software package and retry.	Information
Software Update: Package file corrupted. Regenerate package and retry.	The package file is corrupt, does not have expected SHA256 hash	Regenerate the software package and retry.	Information
Software Update: Unable to find package file.	The package file cannot be found	Verify the package file is on the server.	Information
Software Update: Installation failed. Reboot and retry.	At least one of the sub systems failed to install	Restart the monitor.	Information
Software Update: Upgrade unsuccessful. Insufficient disk space.	The partition is running out of space	Free up adequate space needed to perform the upgrade.	Information
Software Update: Update unsuccessful. Incompatible firmware.	The current firmware version is lower than the one required by the token file	Try to update to an earlier software package.	Information
Software Update: SWUP internal error	SWUP NIBP is not functional	Information status message; click OK button to dismiss.	Information
Software Update: Manager internal error	The Software Update manager is not functional	Information status message; click OK button to dismiss.	Information
Radio software upgrade failed. 350600	The radio software was not upgraded.	Check for software update and apply it. If message is still present, replace the radio.	Very low

Bluetooth® messages

Message	Possible cause	Suggested action	Alarm priority
Bluetooth not functional. 370001	The monitor detected a Bluetooth device that is not functional	Reboot the monitor. If the problem persists, replace the Bluetooth radio. If the problem persists, replace the main PCBA.	Very low
Bluetooth not functional. 370002	The monitor cannot detect a Bluetooth module	Replace the Bluetooth radio. If the problem persists, replace the main PCBA.	Very low

Message	Possible cause	Suggested action	Alarm priority
<i>Bluetooth</i> device connection successful	The <i>Bluetooth</i> device connected	None.	Information
<i>Bluetooth</i> device disconnected	The <i>Bluetooth</i> disconnected	None.	Information

APM messages

Message	Possible cause	Suggested action	Alarm priority
APM not functional. 1C1001	The APM is detected as connected but there is no communication through the APM serial port	Restart the monitor and the APM. If the problem is still present, check the cable connections from the monitor to APM. If the problem still present, replace the APM. If the message persists, replace the main PCBA on the monitor.	Very low
APM not functional. 1C100B	The APM battery is installed, but does not communicate with the monitor	Perform diagnostic checks on the monitor. If the problem is still present, replace the APM battery. If the problem still present, replace the APM. If the message persists, replace the main PCBA on the monitor.	Very low
APM battery is absent or faulty. 1C100F	The APM battery is not installed	Ensure than an APM battery is installed, and install one if it is missing. If the problem is still present, perform diagnostic checks on the monitor. If the problem is still present, replace the APM. If the message persists, replace the main PCBA on the monitor.	Very low
The APM is disconnected. 1C1002	The APM is unplugged from the monitor while the monitor is powered on	Restart the monitor and the APM. If the problem is still present, check the cable connections from the monitor to APM. If the problem still present, replace the APM. If the message persists, replace the main PCBA on the monitor.	Very low
USB cable is disconnected. 1C1003	The APM USB hub is unplugged from the monitor while the monitor is powered on	Restart the monitor and the APM. If the problem is still present, check the cable connections from the monitor to APM. If the problem still present, replace the APM. If the message persists, replace the main PCBA on the monitor.	Very low
APM is plugged in.	The APM was plugged in while the monitor is powered on.	Restart the monitor and the APM. If the problem is still present, check the cable connections from the monitor to APM. If the problem still present, replace the APM. If the message persists, replace the main PCBA on the monitor.	Information
APM not functional. 1C1010	The APM USB hub is plugged in while the monitor communication cable is disconnected	Restart the monitor and the APM. If the problem is still present, check the cable connections from the monitor to APM. If the problem still present, replace the APM. If the	Very low

Message	Possible cause	Suggested action	Alarm priority
		message persists, replace the main PCBA on the monitor.	
APM not functional. 1C1004	The APM PIC cannot communicate with the accelerometer	Restart the monitor and the APM. If the problem is still present, check the cable connections from the monitor to APM. If the problem still present, replace APM. If the message persists, replace the main PCBA on the monitor.	Very low
APM not functional. 1C1009	The APM PIC software update and any retries have failed	Restart the monitor and the APM. If the problem is still present, check the cable connections from the monitor to APM. If the problem still present, retry the software update. If still present, replace the APM. If the message persists, replace the main PCBA on the monitor.	Very low
APM not functional. 1C100B	The APM battery is not recharging	Restart the monitor and the APM. If the problem is still present, check the cable connections from the monitor to APM. If the problem still present, replace the APM. If the message persists, replace the main PCBA on the monitor.	Very low
APM not functional.	The APM USB changes from unplugged to plugged after monitor startup	Restart the monitor and the APM. If the problem is still present, check the cable connections from the monitor to APM. If the problem still present, retry the software update. If still present, replace the APM. If the message persists, replace the main PCBA on the monitor.	Information
Device is operating in battery mode.	AC power cord has been disconnected.	Information status message; press OK button to dismiss.	Information
Sleep mode is unavailable. Intervals monitoring is in progress.	Sleep mode is not allowed when intervals are in progress	Stop any active intervals.	Information
Sleep mode is unavailable. An alarm is active.	Sleep mode is not allowed when alarms are active	Clear all active alarms.	Information
Display lock is unavailable. Missing patient context.	Lockout is not allowed without active patient information	Enter patient information	Information
Power cable is disconnected. 1C1011	The APM communication cable is plugged in while the APM USB cable is disconnected	Restart the monitor and the APM. If the problem is still present, check the cable connections from the monitor to APM. If the problem still present, retry the software update. If still present, replace the APM. If the message persists, replace the main PCBA on the monitor.	Very low

Specifications

Physical specifications

Protection classifications, all monitor configurations

Characteristic	Specification
Electrical rating	100 – 240 V AC, 50 – 60 Hz, 0.8X– 1.5 A
Duty cycle	Continuous operation
Type of protection against electric shock	Class I internally powered
Degree of protection against electric shock, for parts applied to patients	Type BF defibrillator proof IEC EN 60601-1, 2nd and 3rd Editions
Recovery time following defibrillator discharge	Less than or equal to 15 seconds
Flammable anesthetics	 WARNING Not suitable for use with flammable anesthetics.
Degree of protection provided by the enclosure with respect to harmful ingress of liquids	IPX1 Protection against vertically falling drops of water
Height	Standard chassis: 6.3 in. (16.1 cm) Extended chassis: 6.5 in. (16.6 cm) with Braun Extended chassis: 6.4 in. (16.6 cm) with SureTemp
Width	Standard chassis: 9.2 in. (23.4 cm) Extended chassis: 11.7 in. (29.8 cm) with Braun Extended chassis: 11.7 in. (29.8 cm) with SureTemp
Depth	Standard chassis: 2.3 in. (5.8 cm) Extended chassis: 4.4 in. (11.0 cm) with Braun Extended chassis: 4.2 in. (10.6 cm) with SureTemp
Weight (including battery)	Standard chassis: 2.9 lb (1.3 kg) Extended chassis: 3.7 lb (1.7 kg) with Braun Extended chassis: 3.5 lb in. (1.6 kg) with SureTemp

Protection classifications, all monitor configurations

Graphical display resolution

Dimensional outline	6.5 in. (W) x 4.1 in. (H) x 0.13 in. (D) (164.9 mm [H] x 103.8 mm [W] x 3.40 mm [D])
Active area	6.1 in. (W) x 3.4 in. (H) (154.08 mm [W] x 85.92 mm [H])
Resolution	800 x 480 pixels
Pixel arrangement	RGB (red, green, blue)
Pixel size	63.2 μm (W) x 179 μm (H)
Luminance	530 cd/m ²

Speaker volume

Minimum Output sound pressure	60 dB at 1.0 meter
-------------------------------	--------------------

Alarm and pulse tones	per IEC 60601-1-8
------------------------------	-------------------

Pulse frequency (f_0)	150 – 1000 Hz
---------------------------	---------------

Number of harmonic components in the range 300 Hz to 4000 Hz	minimum of 4
--	--------------

Effective pulse duration (t_d)	high priority: 75 – 200 ms medium and low priority: 125 – 250 ms
------------------------------------	---

Rise time (t_r)	10 – 20% of t_d
---------------------	-------------------

Fall time ¹ (t_f)	$t_f \leq t_s - t_r$
----------------------------------	----------------------

Note The range of the relative sound pressure level of the harmonic components should be between a minimum of at least 53 dBA and a maximum of at least 80 dBA at the pulse frequency.

¹Prevents overlap of pulses

Battery specifications

2 Cell battery specifications¹
Hours of use

Continuous run time (Nellcor)	5.22
6 patients/hour - 41 patient cycles (Nellcor)	6.83
8 patients/hour - 54 patient cycles (Nellcor)	6.78
8 patients/hour - 55 patient cycles (Nonin)	6.90

2 Cell battery specifications¹	Hours of use
Acute care continuous 10 minute cycles - 49 patient cycles - BP, temp, SpO2, no radio, no scanner (Nellcor)	8.22
Acute care continuous 10 minute cycles - 50 patient cycles - BP, temp, SpO2, no radio, no scanner (Nonin)	8.37
Acute care continuous 10 minute cycles - 49 patient cycles - BP, temp, SpO2, no radio, no scanner (Masimo)	8.29
Acute care continuous 10 minute cycles - 41 patient cycles - BP, temp, SpO2, radio, scanner (Nellcor)	6.84
Acute care continuous 10 minute cycles - 41 patient cycles - BP, temp, SpO2, radio, scanner (Nonin)	6.96
Acute care continuous 10 minute cycles - 41 patient cycles - BP, temp, SpO2, radio, scanner (Masimo)	6.90

¹ Nellcor is the default for these examples.

Nurse Call specifications

Nurse Call connection specifications	
Nurse Call	25 V AC or 60 V DC maximum at 1A maximum

NIBP specifications

NIBP specifications	
Cuff pressure range	Meets or exceeds IEC/ISO 80601-2-30 standards for cuff pressure range
Systolic range	Adult: 30 to 260 mmHg (StepBP, SureBP) Pediatric: 30 to 260 mmHg (StepBP, SureBP) Neonate: 20 to 120 mmHg (StepBP)
Diastolic range	Adult: 20 to 220 mmHg (StepBP, SureBP) Pediatric: 20 to 220 mmHg (StepBP, SureBP) Neonate: 10 to 110 mmHg (StepBP)
Cuff Inflation Target	Adult: 160 mmHg (StepBP) Pediatric: 140 mmHg (StepBP) Neonate: 90 mmHg (StepBP)
Maximum Target Pressure	Adult: 280 mmHg (StepBP, SureBP) Pediatric: 280 mmHg (StepBP, SureBP) Neonate: 130 mmHg (StepBP)

NIBP specifications

Blood pressure determination time	Typical: 15 seconds Maximum: 150 seconds
Blood pressure accuracy	Meets or exceeds ANSI.AAMI SP10:2002 standards for noninvasive blood pressure accuracy (± 5 mmHg mean error, 8 mmHg standard deviation)
Mean Arterial Pressure (MAP) range The formula used to calculate MAP yields an approximate value.	Adult: 23 to 230 mmHg (StepBP, SureBP) Pediatric: 23 to 230 mmHg (StepBP, SureBP) Neonate: 13 to 110 mmHg (StepBP)
Pulse rate range (using blood pressure determination)	Adult: 30 to 200 bpm (StepBP, SureBP) Pediatric: 30 to 200 bpm (StepBP, SureBP) Neonate: 35 to 220 bpm (StepBP)
Pulse rate accuracy (using blood pressure determination)	$\pm 5.0\%$ (± 3 bpm)
Overpressure cutoff	Adult: 300 mmHg ± 15 mmHg Pediatric: 300 mmHg ± 15 mmHg Neonate: 150 mmHg maximum

SureTemp Plus temperature module specifications**SureTemp Plus temperature module specifications**

Temperature range	80°F to 110°F (26.7°C to 43.3°C)
Calibration accuracy	$\pm 0.2^\circ\text{F}$ ($\pm 0.1^\circ\text{C}$) (Direct mode)

Braun ThermoScan Pro 6000 specifications**Braun ThermoScan PRO 6000 thermometer specifications (refer to Braun ThermoScan Pro 6000's directions for use for additional information)**

Temperature range	68°F to 108°F (20°C to 42.2°C)
Calibration accuracy	<ul style="list-style-type: none"> $\pm 0.4^\circ\text{F}$ ($\pm 0.2^\circ\text{C}$) for temperatures ranging from 95.9°F to 107.6°F (35.5°C to 42°C) $\pm 0.5^\circ\text{F}$ ($\pm 0.25^\circ\text{C}$) for temperatures outside of this range
Display resolution	0.1°F or °C

SpO₂ specifications

Refer to sensor manufacturer's directions for use for additional information.



WARNING Functional testers cannot be used to assess the accuracy of a pulse oximeter monitor.

While functional testers may be useful for verifying that the pulse oximeter sensor, cabling, and monitor are functional, they are incapable of providing the data required to properly evaluate the accuracy of a system's SpO₂ measurements. Fully evaluating the accuracy of the SpO₂ measurements requires, at a minimum, accommodating the wavelength characteristics of the sensor and reproducing the complex optical interaction of the sensor and the patient's tissue. These capabilities are beyond the scope of known bench-top testers. SpO₂ measurement accuracy can only be evaluated in vivo by comparing pulse oximeter readings with SaO₂ measurements obtained from simultaneously sampled arterial blood made using a laboratory CO-oximeter.

Note Contact the sensor manufacturer for further SpO₂ clinical testing information.

Note Refer to sensor manufacturers' directions for use for further accuracy information.

SpO₂ specifications (Masimo specifications, see footnotes 1, 2, 3, 4, 5, and 6)

SpO ₂ performance measurement range	1 to 100%
Masimo SpO₂ specifications	Accuracy specified when used with Masimo SET pulse oximetry monitors or with licensed Masimo SET pulse oximetry modules using PC series patient cables, during no motion. Numbers present ± 1 standard deviation. Plus or minus one standard deviation represents 68% of the population.
Masimo SpO ₂ , No Motion	60 – 80 $\pm 3\%$, adults/pediatrics/infants 70 – 100 $\pm 2\%$, adults/pediatrics/infants; $\pm 3\%$, neonates
Masimo SpO ₂ , Motion	70 – 100 $\pm 3\%$, adults/pediatrics/infants/neonates
Masimo SpO ₂ , Low perfusion	70 – 100 $\pm 2\%$, adults/pediatrics/infants/neonates
Perfusion	0.02 % to 20 %
Masimo pulse rate , No Motion	25 – 240 ± 3 bpm, adults/pediatrics/infants/neonates
Masimo pulse rate, Motion	25 – 240 ± 5 bpm, adults/pediatrics/infants/neonates
Masimo pulse rate, Low perfusion	25 – 240 ± 3 bpm, adults/pediatrics/infants/neonates
Pulse rate	25 to 240 beats per minute (bpm)

SpO2 specifications (Masimo specifications, see footnotes 1, 2, 3, 4, 5, and 6)

	No motion: ± 3 digits Motion: ± 5 digits
Saturation	60% to 70% Adults, Neonates: ± 3 digits
Note	Saturation accuracy varies by sensor type. Refer to the sensor <i>Directions for use</i> for additional accuracy information.

Nellcor sensor accuracy guide^{7, 8}

	SpO2 measurement accuracy can only be evaluated in vivo by comparing pulse oximeter readings with SpO2 measurements obtained from simultaneously sampled arterial blood made using a laboratory CO-oximeter. SpO2 accuracy was validated through breathe-down-equivalent testing by Covidien using electronic measurements to prove equivalence to the Nellcor N600x predicate device. The Nellcor N600x predicate device was validated by performing human-subject, "breathe-down" clinical trials.
Pulse rate	25 to 240 beats per minute (bpm) ± 3 digits (no motion)
Saturation	70% to 100% Adult, neonate: ± 3 digits Low Perfusion: 0.02 % to 20 % ± 2 digits
Note	Saturation accuracy varies by sensor type.
Detected pulse rate	20 to 250 beats per minute (bpm) ± 3 digits

Nonin sensor accuracy guide

	SpO2 accuracy testing is conducted during induced hypoxia studies on healthy, non-smoking, light-to-dark-skinned subjects during motion and no-motion conditions in an independent research laboratory. The measured arterial hemoglobin saturation value (SpO2) of the sensors is compared to arterial hemoglobin oxygen (SaO2) value, determined from blood samples with a laboratory co-oximeter. The accuracy of the sensors in comparison to the co-oximeter samples measured over the SpO2 range of 70 – 100%. Accuracy data is calculated using the root-mean-squared (A_{rms} value) for all subjects, per ISO 9919:2005, Standard Specification for Pulse Oximeters for Accuracy.
Perfusion	40–240 BPM. Adult/Ped = +/- 3 digits; Neonate = +/- 3 digits
Pulse rate	18 to 321 beats per minute (bpm) No motion (18 to 300 bpm): ± 3 digits Motion (40 to 240 bpm): ± 5 digits
Saturation	70% to 100% 70% to 100%
Note	Saturation accuracy varies by sensor type. Adult/Pediatrics Neonates No Motion No Motion Finger Clip: ± 3 digits

SpO2 specifications (Masimo specifications, see footnotes 1, 2, 3, 4, 5, and 6)

Finger Clip: ± 2 digits	Flex: ± 3 digits
Flex: ± 3 digits	Soft Sensor: N/A
Soft Sensor: ± 2 digits	8000R: N/A
8000R: ± 3 digits	8000 Q: N/A
8000 Q: ± 4 digits	Motion
Motion	Finger Clip: ± 3 digits
Finger Clip: ± 2 digits	Flex: ± 4 digits
Flex: ± 3 digits	Soft Sensor: ± 4 digits
Soft Sensor: ± 3 digits	Low Perfusion
Low Perfusion	All Sensors: ± 3 digits
All Sensors: ± 2 digits	

¹ SpO₂ accuracy was determined by testing on healthy adult volunteers in the range of 60-100% SpO₂ against a laboratory pulse oximeter. SpO₂ accuracy was determined on 16 neonatal NICU patients ranging in age from 7-135 days old and weighing between 0.5-4.25 kg. Seventy-nine (79) data samples were collected over a range of 70-100% SaO₂ with a resultant accuracy of 2.9% SpO₂.

² The Masimo sensors have been validated for no motion accuracy in human blood studies on healthy adult male and female volunteers with light to dark skin pigmentation in induced hypoxia studies in the range of 70-100% SpO₂ against a laboratory pulse oximeter and ECG monitor. This variation equals plus or minus one standard deviation. Plus or minus one standard deviation encompasses 68% of the population.

³ The Masimo sensors have been validated for motion accuracy in human blood studies on healthy adult male and female volunteers with light to dark skin pigmentation in induced hypoxia studies in the range of 70-100% SpO₂ against a laboratory CO-oximeter and ECG monitor. This variation equals plus or minus one standard deviation which encompasses 68% of the population.

⁴ The Masimo SET Technology has been validated for low perfusion accuracy in bench top testing against a Biotek Index 2 simulator and Masimo's simulator with signal strengths of greater than 0.02% and transmission of greater than 5% for saturations ranging from 70-100%. This variation equals plus or minus one standard deviation which encompasses 68% of the population.

⁵ The Masimo sensors have been validated for pulse rate accuracy for the range of 25-240 bpm in bench top testing against a Biotek Index 2 simulator. This variation equals plus or minus one standard deviation which encompasses 68% of the population.

⁶ The following substances may interfere with pulse oximetry measurements:

- Elevated levels of Methemoglobin (MetHb) may lead to inaccurate SpO₂ measurements
- Elevated levels of Carboxyhemoglobin (COHb) may lead to inaccurate SpO₂ measurements
- Severe anemia may cause erroneous SpO₂ readings
- Dyes, or any substance containing dyes, that change usual blood pigmentation may cause erroneous readings
- Elevated levels of total bilirubin may lead to inaccurate SpO₂ reading

⁷ Some models of commercially available bench-top functional testers and patient simulators can be used to verify the proper functionality of Nellcor pulse oximeter sensors, cables and monitors. See the individual testing device's operator's directions for use for the procedures specific to the model of tester being used.

⁸ Many functional testers and patient simulators have been designed to interface with the pulse oximeter's expected calibration curves and may be suitable for use with Nellcor monitors and/or sensors. Not all such devices, however, are adapted for use with the Nellcor OXIMAX digital calibration system. While this will not affect use of the simulator for verifying system functionality, displayed SpO₂ measurement values may differ from the setting of the test device. For a properly functioning monitor, this difference will be reproducible over time and from monitor to monitor within the performance specifications of the test device.

Environmental specifications

Operating temperature	50°F to 104°F (10°C to 40°C)
Storage temperature	-4°F to 122°F (-20°C to 50°C)
Operating altitude	-1250 to 10,000 ft. (-381 m to 3,048 m)
Operating humidity	15% to 90% noncondensing
Storage humidity	15% to 95% noncondensing

Monitor radio

The monitor's radio operates on 802.11 networks.

Wireless network interface	IEEE 802.11 a/b/g/n	
Frequency	2.4 GHz frequency bands	5 GHz frequency bands
	2.4 GHz to 2.483 GHz	5.15 GHz to 5.35 GHz, 5.725 GHz to 5.825GHz
Channels	2.4 GHz channels	5 GHz
	Up to 14 (3 non-overlapping); country-dependent,	Up to 23 non overlapping; country-dependent
Authentication/Encryption	Wireless Equivalent Privacy (WEP, RC4 Algorithm); Wi-Fi Protected Access (WPA); IEEE 802.11i (WPA2); TKIP, RC4 Algorithm; AES, Rijndael Algorithm; Encryption Key Provisioning; Static (40-bit and 128-bit lengths); PSK; Dynamic; EAP-FAST; EAP-TLS; EAP-TTLS; PEAP-GTC ¹ PEAP-MSCHAPv2; PEAP-TLS;	
Antenna	Ethertronics WLAN_1000146	
Wireless data rates	802.11a (OFDM): 6, 9, 12, 18, 24, 36, 48, 54 Mbps	
	802.11b (DSSS, CCK): 1, 2, 5.5, 11 Mbps	
	802.11g (OFDM): 6, 9, 12, 18, 24, 36, 48, 54 Mbps	

	802.11n (OFDM,HT20,MCS 0-7): 6.5,13,19.5, 26, 39,52, 58.5, 72.2 Mbps
Agency approvals	US: FCC Part 15.247 Subpart C, FCC Part 15.407 Subpart E Europe: EN 300 328 (EDR) (v1.8.1), EN 300 328 (LE) (v1.8.1), EN 301 489-1 (v1.9.2), EN 301 489-17 (v2.2.1), EN 301 489-17 (v2.2.1), EN 62311:2008, EN 60950-1 Canada: (IC) RSS-210 standard. IC 3147A-WB45NBT based on FCC testing Singapore: Complies with IDS standard
Protocols	UDP, DHCP, TCP/IP
Data transfer protocols	UDP/TCP/IP
Output power	39.81mW typical, country-dependent
Ancillary IEEE standards	802.11d, 802.11e, 802.11h, 802.11i, 802.1X

¹One time passwords are not supported.

Channel restrictions in the 5-GHz band are determined by country. To ensure compliance with local regulations, be sure the correct country in which the access point is installed is selected. This product can be used with the following restriction(s):

Norway - Does not apply for the geographical area within a radius of 20 km from the center of Ny-Ålesund.

France - Outdoor use is limited to 10 mW EIRP within the band 2454 to 2483.5 MHz.

Note Effective Isotropic Radiated Power (EIRP).

Note Some countries restrict the use of 5-GHz bands. The 802.11a radio in the monitor uses only the channels indicated by the access point with which the radio associates. The hospital IT department must configure access points to operate with approved domains.

Bluetooth[®] module

Category	Feature	Implementation
Wireless specification	Bluetooth	2.1 + EDR
	Frequency	2.402 - 2.480 GHz
	Maximum transmit power	Class 1 +8 dBm from antenna
	Receive sensitivity	-89 dBm
	Range	Circa 100 meters
	Data rates	Up to 3 Mbps (over the air)
Host interface	USB	Full speed USB 2.0

	GPIO	Four configurable lines (1.8V/3.3V configurable by VDD_PADS)
Operational modes	HCI	Host Controller Interface over USB
	HID proxy mode	Human Interface Device
EEPROM	2-wire	64K bits
Coexistence	802.11 (WiFi)	Three wire CSR schemes supported (Unity-3, Unity-3e, and Unity+)
Supply voltage	Supply	5V ± 10%
Power consumption	Current	Idle mode ~5 mA File transfer ~58 mA
Antenna option	Internal	Multilayer ceramic antenna with up to 41% efficiency
Physical	Dimensions	8.5 × 13 × 1.6 mm (BT800 module) 16 × 43 × 11 (BT820 USB dongle)
Environmental	Operating	-30 °C to 85 °C
	Storage	-40 °C to 85 °C
Miscellaneous	Lead free	Lead-free and RoHS compliant
	Warranty	1 year
Approvals	Bluetooth	Controller subsystem approved
	FCC / IC / CE	All BT800 series

Configuration options

The monitor is available in multiple configurations. See the *Service manual* for upgrade options available for each configuration presented below

Model	Description
7100	Base. Includes NIBP, USB, and Ethernet connectivity.
7300	Same features as 7100. Includes Bluetooth® wireless technology
7400	Same features as 7100. Includes Masimo or Nellcor SpO2
7500	Same features as 7400. Choice of Masimo, Nellcor, or Nonin SpO2. WiFi built in.

Standards and compliance

General compliance and standards

The monitor complies with the following standards:

21 CFR Subchapter H – Medical Devices – US Food and Drug Administration
 2002 No. 236 – Australian Therapeutic Goods Act
 93/42/EEC – European Economic Community Medical Devices Directive
 2007/47/EC – European Economic Community Medical Devices Directive 2007
 Amendment
 94/62/EC – European Economic Community Packaging Directive
 2002/96/EC – European Economic Community Waste Electrical and Electronic
 Equipment Directive
 2006/66/EC – European Economic Community Batteries and Accumulators Directive
 SOR/98-282 – Canadian Medical Devices Regulation
 IATA DGR – International Air Transport Association Dangerous Goods Regulation
 United Nations ST/SG/AC.10/11 – Manual of Tests and Criteria, Part III, Sub-Section 38.3

ANSI/AAMI SP10
 AS/NZS 3200.1.0¹
 ASTM D 4332, E 1104
 CAN/CSA C22.2 NO.601.1¹ CAN/CSA-C22.2 NO.60601-1-2, CSA Z9919
 EN 1060-1, 1060-3, 1060-4²
 EN/IEC 60601-1, 60601-1-2, 60601-1-8, 60601-2-30, 62304, 80601-2-30, 62366,
 60601-1-6
 EN/ISO 9919, 13485, 14971, 80601-2-56, 80601-2-61
 ISTA 2A
 UL 60601-1¹



**Directive 2002/96/EC-WEEE:
 Disposal of noncontaminated electrical and electronic equipment**

This product and its accessories must be disposed of according to local laws and regulations. Do not dispose of this product as unsorted municipal waste. Prepare this product for reuse or separate collection as specified by Directive 2002/96/EC of the European Parliament and the Council of the European Union on Waste Electronic and

¹ Standard is essentially the IEC 60601-1 General standard plus the listed country's National Deviations.

² Non-Invasive Sphygmomanometers – Part 1: General Requirements, Part 3. Supplementary Requirements for Electro-Mechanical Blood Pressure Measuring Systems, Part 4: Test Procedures to Determine the Overall System Accuracy of Automated Non-Invasive Sphygmomanometers.

Electrical Equipment (WEEE). If this product is contaminated, this directive does not apply.

For more specific disposal or compliance information, see www.welchallyn.com/weee, or contact Welch Allyn Customer Service at +44 207 365 6780.

General radio compliance

The wireless features of this monitor must be used in strict accordance with the manufacturer's instructions as described in the user documentation that comes with the product.

This device complies with Part 15 of the FCC rules and with the rules of the Canadian ICES-003 as described below.

Federal Communications Commission (FCC)

This device complies with part 15 of the FCC Rules. Operation is subject to the following two conditions:

- This device may not cause harmful interference.
- This device must accept any interference received, including interference that may cause undesired operation.

This equipment has been tested and found to comply with the limits for a Class B digital device, pursuant to Part 15 of FCC Rules. These limits are designed to provide reasonable protection against harmful interference in a residential installation. This equipment generates, uses, and can radiate radio frequency energy. If not installed and used in accordance with the instructions, it may cause harmful interference to radio communications. However, there is no guarantee that interference will not occur in a particular installation. If this equipment does cause harmful interference to radio or television reception, which can be determined by turning the equipment off and on, the user is encouraged to try and correct the interference by one or more of the following measures:

- Reorient or relocate the receiving antenna
- Increase the distance between the equipment and the receiver
- Connect the equipment to an outlet on a circuit different from that to which the receiver is connected
- Consult the dealer or an experienced radio/TV technician for help

The user may find the following booklet prepared by the Federal Communications Commission helpful:

The Interference Handbook

This booklet is available from the U.S. Government Printing Office, Washington, D.C. 20402. Stock No. 004-000-0034504.

Welch Allyn is not responsible for any radio or television interference caused by unauthorized modification of the devices included with this Welch Allyn product, or the substitution or attachment of connecting cables and equipment other than specified by Welch Allyn.

The correction of interference caused by such unauthorized modification, substitution, or attachment will be the responsibility of the user.

Industry Canada (IC) emissions

This device complies with RSS 210 of Industry Canada.

Operation is subject to the following two conditions: (1) this device may not cause interference, and (2) this device must accept any interference, including interference that may cause undesired operation of this device.

L'utilisation de ce dispositif est autorisée seulement aux conditions suivantes: (1) il ne doit pas produire de brouillage et (2) l'utilisateur du dispositif doit être prêt à accepter tout brouillage radioélectrique reçu, même si ce brouillage est susceptible de compromettre le fonctionnement du dispositif.

This Class B digital apparatus complies with Canadian ICES-003.

Cet appareil numérique de la classe B est conforme à la norme NMB-003 du Canada.

RF Radiation Hazard Warning

Using higher gain antennas and types of antennas not certified for use with this product is not allowed. The device shall not be co-located with another transmitter.

Cet avertissement de sécurité est conforme aux limites d'exposition définies par la norme CNR-102 relative aux fréquences radio.

This radio transmitter (Contains IC ID: 3147A-BT800) has been approved by Industry Canada to operate with the antenna types listed in table above with the maximum permissible gain and required antenna impedance for each antenna type indicated. Antenna types not included in this list, having a gain greater than the maximum gain indicated for that type, are strictly prohibited for use with this device.

Le présent émetteur radio (Contient l'ID IC : 3147A-BT800) a été approuvé par Industrie Canada pour fonctionner avec les types d'antenne énumérés ci-dessous et ayant un gain admissible maximal et l'impédance requise pour chaque type d'antenne. Les types d'antenne non inclus dans cette liste, ou dont le gain est supérieur au gain maximal indiqué, sont strictement interdits pour l'exploitation de l'émetteur.

Under Industry Canada regulations, this radio transmitter may only operate using an antenna of a type and maximum (or lesser) gain approved for the transmitter by Industry Canada. To reduce potential radio interference to other users, the antenna type and its gain should be so chosen that the equivalent isotropically radiated power (e.i.r.p.) is not more than that necessary for successful communication.

Conformément à la réglementation d'Industrie Canada, le présent émetteur radio peut fonctionner avec une antenne d'un type et d'un gain maximal (ou inférieur) approuvé pour l'émetteur par Industrie Canada. Dans le but de réduire les risques de brouillage radioélectrique à l'intention des autres utilisateurs, il faut choisir le type d'antenne et son gain de sorte que la puissance isotrope rayonnée équivalente (p.i.r.e.) ne dépasse pas l'intensité nécessaire à l'établissement d'une communication satisfaisante.

This device complies with Industry Canada license-exempt RSS standard(s). Operation is subject to the following two conditions: (1) this device may not cause interference, and (2) this device must accept any interference, including interference that may cause undesired operation of the device.

Le présent appareil est conforme aux CNR d'Industrie Canada applicables aux appareils radio exempts de licence. L'exploitation est autorisée aux deux conditions suivantes : (1) l'appareil ne doit pas produire de brouillage, et (2) l'utilisateur de l'appareil doit accepter

tout brouillage radioélectrique subi, même si le brouillage est susceptible d'en compromettre le fonctionnement.

European Union

Czech	Welch Allyn tímto prohlašuje, že tento RLAN device je ve shodě se základními požadavky a dalšími příslušnými ustanoveními směrnice 1999/5/ES.
Danish	Undertegnede Welch Allyn erklærer herved, at følgende udstyr RLAN device overholder de væsentlige krav og øvrige relevante krav i direktiv 1999/5/EF
Dutch	Bij deze verklaart Welch Allyn dat deze RLAN device voldoet aan de essentiële eisen en aan de overige relevante bepalingen van Richtlijn 1999/5/EC.
English	Hereby, Welch Allyn, declares that this RLAN device is in compliance with the essential requirements and other relevant provisions of Directive 1999/5/EC.
Estonian	Käesolevaga kinnitab Welch Allyn seadme RLAN device vastavust direktiivi 1999/5/EÜ põhinõuetele ja nimetatud direktiivist tulenevatele teistele asjakohastele sätetele.
Finnish	Welch Allyn vakuuttaa täten että RLAN device tyyppinen laite on direktiivin 1999/5/EY oleellisten vaatimusten ja sitä koskevien direktiivin muiden ehtojen mukainen.
French	Par la présente, Welch Allyn déclare que ce RLAN device est conforme aux exigences essentielles et aux autres dispositions de la directive 1999/5/CE qui lui sont applicables
German	Hiermit erklärt Welch Allyn die Übereinstimmung des Gerätes RLAN device mit den grundlegenden Anforderungen und den anderen relevanten Festlegungen der Richtlinie 1999/5/EG. (Wien)
Greek	ΜΕ ΤΗΝ ΠΑΡΟΥΣΑ Welch Allyn ΔΗΛΩΝΕΙ ΟΤΙ RLAN device ΣΥΜΜΟΡΦΩΝΕΤΑΙ ΠΡΟΣ ΤΙΣ ΟΥΣΙΩΔΕΙΣ ΑΠΑΙΤΗΣΕΙΣ ΚΑΙ ΤΙΣ ΛΟΙΠΕΣ ΣΧΕΤΙΚΕΣ ΔΙΑΤΑΞΕΙΣ ΤΗΣ ΟΔΗΓΙΑΣ 1999/5/EK
Hungarian	Alulírott, Welch Allyn nyilatkozom, hogy a RLAN device megfelel a vonatkozó alapvető követelményeknek és az 1999/5/EC irányelv egyéb előírásainak.
Italian	Con la presente Welch Allyn dichiara che questo RLAN device è conforme ai requisiti essenziali ed alle altre disposizioni pertinenti stabilite dalla direttiva 1999/5/CE.
Latvian	Ar šo Welch Allyn deklarē, ka RLAN device atbilst Direktīvas 1999/5/EK būtiskajām prasībām un citiem ar to saistītajiem noteikumiem.
Lithuanian	Šiuo Welch Allyn deklaruoja, kad šis RLAN device atitinka esminius reikalavimus ir kitas 1999/5/EB Direktyvos nuostatas.
Malti	Hawnhekk, Welch Allyn, jiddikjara li dan RLAN device jikkonforma mal-htigijiet essenzjali u ma provvedimenti oħrajn relevanti li hemm fid-Direttiva 1999/5/EC
Portuguese	Welch Allyn declara que este RLAN device está conforme com os requisitos essenciais e outras disposições da Directiva 1999/5/CE.
Slovak	Welch Allyn týmto vyhlasuje, že RLAN device spĺňa základné požiadavky a všetky príslušné ustanovenia Smernice 1999/5/ES.
Slovene	Šiuo Welch Allyn deklaruoja, kad šis RLAN device atitinka esminius reikalavimus ir kitas 1999/5/EB Direktyvos nuostatas.

Spanish	Por medio de la presente Welch Allyn declara que el RLAN device cumple con los requisitos esenciales y cualesquiera otras disposiciones aplicables o exigibles de la Directiva 1999/5/CE
---------	--

Swedish	Härmed intygar Welch Allyn att denna RLAN device står i överensstämmelse med de väsentliga egenskapskrav och övriga relevanta bestämmelser som framgår av direktiv 1999/5/EG.
---------	---

Guidance and manufacturer's declaration

EMC compliance

Special precautions concerning electromagnetic compatibility (EMC) must be taken for all medical electrical equipment. This device complies with IEC EN 60601-1-2:2007.

- All medical electrical equipment must be installed and put into service in accordance with the EMC information provided in this *Directions for use*.
- Portable and mobile RF communications equipment can affect the behavior of medical electrical equipment.

The monitor complies with all applicable and required standards for electromagnetic interference.

- It does not normally affect nearby equipment and devices.
- It is not normally affected by nearby equipment and devices.
- It is not safe to operate the monitor in the presence of high-frequency surgical equipment.
- However, it is good practice to avoid using the monitor in extremely close proximity to other equipment.

Emissions and immunity information

Electromagnetic emissions

The monitor is intended for use in the electromagnetic environment specified below. The customer or user of the monitor should assure that it is used in such an environment.

Emissions test	Compliance	Electromagnetic environment - guidance
RF emissions CISPR 11	Group 1	The monitor uses RF energy only for its internal function. Therefore, its RF emissions are very low and are not likely to cause any interference in nearby electronic equipment.
RF emissions CISPR 11	Class B	The CSM is suitable for use in all establishments, including domestic establishments and those directly connected to the public low voltage power supply network that supplies buildings used for domestic purposes.
Harmonic emissions IEC 61000-3-2	Class A	

Electromagnetic emissions

Voltage fluctuations/
flicker emissions
IEC 61000-3-3

Complies



WARNING This equipment/system is intended for use by healthcare professionals only. This equipment/ system may cause radio interference or may disrupt the operation of nearby equipment^a. It may be necessary to take mitigation measures, such as re-orienting or relocating the monitor or shielding the location.

^a The monitor contains a 5-GHz orthogonal frequency-division multiplexing transmitter or a 2.4-GHz frequency hopping spread-spectrum transmitter for the purpose of wireless communication. The radio is operated according to the requirements of various agencies, including FCC 47 CFR 15.247 and R&TTE Directive (1995/5/EC). The transmitter is excluded from the EMC requirements of 60601-1-2, but should be considered when addressing possible interference issues between this and other devices.

Electromagnetic immunity

The monitor is intended for use in the electromagnetic environment specified below. The customer or the user of the monitor should assure that it is used in such an environment.

Immunity test	IEC 60601 test level	Compliance level	Electromagnetic environment - guidance
Electrostatic discharge (ESD) IEC 61000-4-2	±6 kV contact ± 8 kV air	± 6 kV contact ± 8 kV air	Floors should be wood, concrete or ceramic tile. If floors are covered with synthetic material, the relative humidity should be at least 30%.
Electrical fast transient/burst IEC 61000-4-4	±2 kV for power supply lines ±1 kV for input/output lines	±2 kV for power supply lines ±1 kV for input/output lines	Mains power quality should be that of a typical commercial or hospital environment.
Surge IEC 61000-4-5	± 1 kV differential mode ± 2 kV common mode	± 1 kV differential mode ± 2 kV common mode	Mains power quality should be that of a typical commercial or hospital environment.
Voltage dips, short interruptions and voltage variations on power supply input lines IEC 61000-4-11	>95% dip in 0.5 cycle 60% dip in 5 cycles 30% dip for 25 cycles >95% dip in 5 seconds	>95% dip in 0.5 cycle 60% dip in 5 cycles 30% dip for 25 cycles >95% dip in 5 seconds	Mains power quality should be that of a typical commercial or hospital environment. If the user of the monitor requires continued operation during power mains interruptions, it is recommended that the monitor be powered from an uninterruptible power supply or a battery.

Electromagnetic immunity

The monitor is intended for use in the electromagnetic environment specified below. The customer or the user of the monitor should assure that it is used in such an environment.

Immunity test	IEC 60601 test level	Compliance level	Electromagnetic environment - guidance
			Portable and mobile RF communications equipment should be used no closer to any part of the monitor, including cables, than the recommended separation distance calculated

Electromagnetic immunity			
from the equation applicable to the frequency of the transmitter.			
Recommended separation distance			
Conducted RF IEC 61000-4-6	3 Vrms 150 kHz to 80 MHz	3 Vrms	$d = (1.17) \sqrt{P}$
Radiated RF IEC 61000-4-3	3 V/m 80 MHz to 1 GHz	3 V/m	$d = (1.17) \sqrt{P}$ 80 to 800 MHz

$$d = (2.33) \sqrt{P} \text{ 800 MHz to 2,5 GHz}$$

where P is the maximum output power rating of the transmitter in watts (W) and d is the recommended separation distance in meters (m). Field strengths from fixed RF transmitters, as determined by an electromagnetic site survey^a, should be less than the compliance level in each frequency range^b. Interference may occur in the vicinity of equipment marked with the following symbol:



Note1: At 80 MHz and 800 MHz, the higher frequency range applies.

Note 2: These guidelines may not apply in all situations. Electromagnetic propagation is affected by absorption and reflection from structures, objects, and people.

^aField strengths from fixed transmitters, such as base stations for radio (cellular/cordless) telephones and land mobile radios, amateur radio, AM and FM radio broadcast, and TV broadcast cannot be predicted theoretically with accuracy. To assess the electromagnetic environment due to fixed RF transmitters, an electromagnetic site survey should be considered. If the measured field strength in the location in which the monitor is used exceeds the applicable RF compliance level above, the monitor should be observed to verify normal operation. If abnormal performance is observed, additional measures may be necessary, such as reorienting or relocating the monitor.

^bOver the frequency range 150 kHz to 80 MHz, field strengths should be less than 3 V/m.

Recommended separation distances between portable and mobile RF communications equipment and the monitor

The monitor is intended for use in an electromagnetic environment in which radiated RF disturbances are controlled. The customer or user of the monitor can help prevent electromagnetic interference by maintaining a minimum distance between portable and mobile RF communications equipment (transmitters) and the monitor as recommended below, according to the maximum output power of the communications equipment.

Separation distance according to frequency of transmitter (m)			
Rated max. output power of transmitter (W)	150 kHz to 80 MHz	80 MHz to 800 MHz	800 MHz to 2.5 GHz
	$d = (1.17) \sqrt{P}$	$d = (1.17) \sqrt{P}$	$d = (2.23) \sqrt{P}$
0.01	0.11667	0.11667	0.23333

Recommended separation distances between portable and mobile RF communications equipment and the monitor

0.1	0.36894	0.36894	0.73785
1	1.1667	1.1667	2.3333
10	3.6894	3.6894	7.3785
100	11.667	11.667	23.3333

For transmitters rated at a maximum output power not listed above, the recommended separation distance d in meters (m) can be estimated using the equation applicable to the frequency of the transmitter, where P is the maximum output power rating of the transmitter in watts (W) according to the transmitter manufacturer.

Note 1: At 80 MHz and 800 MHz, the separation distance for the higher frequency range applies.

Note 2: These guidelines may not apply in all situations. Electromagnetic propagation is affected by absorption and reflection from structures, objects, and people.

Appendices

Approved accessories

The following tables list approved monitor accessories and applied parts. For information about options, upgrades, and licenses, refer to the service manual.



WARNING Use only Welch Allyn approved accessories and applied parts, and use them according to the manufacturer's directions for use. Using unapproved accessories with the monitor or applied parts can affect patient and operator safety and can compromise product performance and accuracy, and void the product warranty.

Accessories

Blood pressure accessories (latex-free)

Part number	Model	Description
4500-33	BP	FAST BP HOSE W FPORT, 8 FT
4500-34	BP	FAST BP HOSE W FPORT, 5 FT
4500-35	BP	FAST BP HOSE W FPORT, 10 FT
6000-30	BP	Single tube blood pressure hose (5 ft)
6000-31	BP	Single tube blood pressure hose (10 ft)
7000-33	BP	Neonatal blood pressure hose (10 ft)
5200-08		Calibration "T" connector

Masimo pulse oximetry (for use with devices with SpO2)

Part number	Model	Description
LNC-4	LNCS	4' Cable w/ MINID Connector
LNC-10	LNCS	10' Cable w/ MINID Connector

Nellcor pulse oximetry

Part number	Model	Description
DS-100A	OxiMax	Durasensor adult oxygen transducer
DOC-10	OxiMax	Extension cable (10 feet)
DOC-8	OxiMax	Extension cable (8 feet)
DOC-4	OxiMax	Extension cable (4 feet)

Nonin pulse oximetry

Part number	Model	Description
6083-001		1m Nonin Extension Cable
6083-003		3m Nonin Extension Cable

SureTemp Plus thermometry

Part number	Description
02895-000	Oral probe and well kit (9ft. / 2.7M)
02895-100	Rectal probe and well kit (9ft. / 2.7M)
02894-0000	Oral probe well (blue)
02894-1000	Rectal probe well (red)
06138-000	Temperature calibration key
01802-110	9600 Plus Calibration Tester

Braun ThermoScan PRO 6000 thermometer and accessory dock

Part number	Description
106201	Pro 6000 tether w/6 ft cord
106204	Pro 6000 tether w/9 ft cord
106205	Pro 6000 battery door
104894	Pro 6000 rechargeable battery
105804	Braun PRO 6000 Thermometer DFU CD

Mounting options

Part number	Description
7000-APM	Accessory Power Management (APM) — organized mobile stand with battery and basket
7000-MS3	Connex Spot Classic Mobile Stand, MS3

Miscellaneous items

Part number	Description
104894	Pro6000 Rechargeable Battery
718584	Tether for PRO 6000 with 9 ft Cord
7000-APM	Connex Spot Accessory Power Mgt Stand
7000-MS3	Connex Spot Classic Mobile Stand MS3
BATT99	Lithium-ion battery 9 Cell — Extended Life
7000-100S	Carrying case, soft sided
PWCD-B	Line cord B, North America
PWCD-2	Line cord 2, Europe
PWCD-A	Line cord A, Denmark
PWCD-5	Line cord 5, Switzerland
PWCD-4	Line cord 4, United Kingdom
PWCD-6	Line cord 6, Australia/New Zealand
PWCD-66	Line cord 6, Australia/New Zealand —Orange
PWCD-C	Line cord C, China
PWCD-G	Line cord G, Argentina
PWCD-7	Line cord 7, South Africa
PWCD-N	Line cord N, India
PWCD-3	Line cord 3, Israel
PWCD-Y	Line cord Y, Italy
PWCD-K	Line cord K, South Korea
PWCD-T	Line cord T, Taiwan

Part number	Description
PWCD-P	Line cord P, Thailand
PWCD-Z	Line cord Z, Brazil
6000-NC	Nurse call cable
6000-916	Honeywell 1900 2D Scanner
6000-916HS	Jadak 2D Scanner
4500-925	USB cable for wired connectivity
7000-BOX	Connex Spot Packaging (Empty Box Set)
660-0321-00	Patch cable, 50'
660-0320-00	Patch cable, 100'
660-0138-00	Patch cable, 5'
6000-50	VSM 6000 USB Configuration Memory Stick
7000-PS	Connex Spot 35 Watt Power Supply
4600-90E	BP Accuracy, Variability Card

Service

Part number	Description
S1-CSM	CSM, Comprehensive partnership program, 1 year
S1-CSM-2	CSM, Comprehensive partnership program, 2 years
S1-CSM-5	CSM, Comprehensive partnership program, 5 years
S1-CSM-C	CSM, Comprehensive partnership program, 1 years + Calibration
S1-CSM-2C	CSM, Comprehensive partnership program, 2 years + Calibration
S1-CSM-5C	CSM, Comprehensive partnership program, 5 years + Calibration
S2-CSM	CSM, Biomed partnership program, 1 year
S2-CSM-2	CSM, Biomed partnership program, 2 years
S2-CSM-5	CSM, Biomed partnership program, 5 years
S4-CSM	CSM, Warranty Extension, 1 year
S4-CSM-2	CSM, Warranty Extension, 2 years

Part number	Description
S4-CSM-5	CSM, Warranty Extension, 5 years

Literature/Documentation

Part number	Description
7000-DFU-CD	Connex Spot CD Kit (Directions for use, Quick reference cards, Startup guide, Service manual)

Applied parts

FlexiPort cuffs

Part number	Model	Description
Neo-1-1		Neo 1 with new fitting
Neo-2-1		Neo 2 with new fitting
Neo-3-1		Neo 3 with new fitting
Neo-4-1		Neo 4 with new fitting
Neo-5-1		Neo 5 with new fitting
Reuse-06	Reusable	CUFF, Welch Allyn, REUSABLE, SMALL INFANT
Reuse-07	Reusable	CUFF, Welch Allyn, REUSABLE, INFANT
Reuse-08	Reusable	CUFF, Welch Allyn, REUSABLE, SM CHILD
Reuse-09	Reusable	CUFF, Welch Allyn, REUSABLE, CHILD
Reuse-10	Reusable	CUFF, Welch Allyn, REUSABLE, SM ADULT
Reuse-11	Reusable	CUFF, Welch Allyn, REUSABLE, ADULT
Reuse-11L	Reusable	CUFF, Welch Allyn, REUSABLE ADULT LONG
Reuse-12	Reusable	CUFF, Welch Allyn, REUSABLE, LG ADULT
Reuse-12L	Reusable	CUFF, Welch Allyn, REUSABLE, LG ADULT LONG
Reuse-13	Reusable	CUFF, Welch Allyn, REUSABLE, THIGH
Soft-06	Disposable	CUFF, Welch Allyn, SMALL INFANT

Part number	Model	Description
Soft-07	Disposable	CUFF, Welch Allyn, INFANT
Soft-08	Disposable	CUFF, Welch Allyn, SMALL CHILD
Soft-09	Disposable	CUFF, Welch Allyn, CHILD
Soft-10	Disposable	CUFF, Welch Allyn, SMALL ADULT
Soft-11	Disposable	CUFF, Welch Allyn, ADULT
Soft-11L	Disposable	CUFF, Welch Allyn, ADULT LONG
Soft-12	Disposable	CUFF, Welch Allyn, LG ADULT
Soft-12L	Disposable	CUFF, Welch Allyn, LG ADULT LONG
Soft-13	Disposable	CUFF, Welch Allyn, THIGH
ECOCUFF-09	Disposable	EcoCuff, Child, 1521 cm
ECOCUFF-10	Disposable	EcoCuff, Small Adult, 2028 cm
ECOCUFF-11	Disposable	EcoCuff, Adult, 2738 cm
ECOCUFF-12	Disposable	EcoCuff, Large Adult, 3345 cm
ECOCUFF-MLT	Disposable	ECOCUFF, MULTI PACK

Masimo pulse oximetry (for use with devices with SpO2)

Part number	Model	Description
LNCS-DCI	LNCS	Reusable finger sensor - Adult
LNCS-DCIP	LNCS	Reusable finger sensor - Pediatric
LNCS-ADTX	LNCS	Disposable adhesive finger sensor - Adult (20 per case)
LNCS-PDTX	LNCS	Disposable adhesive finger sensor - Pediatric (20 per case)
LNCS-YI	LNCS	Multisite reusable sensor (1 sensor, 6 adhesive wraps)
LNCS-TC-I	LNCS	Reusable ear sensor
LNCS-Neo-L-3	LNCS	Disposable adhesive finger sensor - Neonate/Adult (20 per case)
Neo-Wrap-RP	LNCS	Replacement wrap for neonatal adhesives (100 per case)

Part number	Model	Description
LNCS-Inf-3	LNCS	Disposable adhesive finger sensor - Infant (20 per case)
Inf-Wrap-RP	LNCS	Replacement wrap for infant adhesives (100 per case)
YI-AD	LNCS	Multisite adhesive wrap adult/pediatric/neonatal for YI sensor (100 per case)
YI-FM	LNCS	Multisite foam wrap adult/pediatric/neonatal for YI sensor (12 per case)

Nellcor pulse oximetry

Part number	Model	Description
DS-100A	OxiMax	Durasensor adult oxygen transducer
D-YS	OxiMax	Dura-Y oxygen transducer (1 sensor, 40 wraps)
D-YSE	OxiMax	Ear clip (use with Dura-Y sensor)
D-YSPD	OxiMax	PediCheck pediatric spot check (use with Dura-Y sensor)
MAX-AI	OxiMax	OxiMax adult sensor (single use, case of 24)
MAX-PI	OxiMax	OxiMax pediatric sensor (single use, case of 24)
MAX-II	OxiMax	OxiMax infant sensor (single use, case of 24)
OXI-A/N	OxiMax	Oxiband adult/neonatal transducer (1 sensor, 50 wraps)
OXI-P/I	OxiMax	Oxiband pediatric/infant transducer (1 sensor, 50 wraps)

Nonin pulse oximetry

Part number	Description
3278-010	8000AP NONIN SPO2 SENSOR, ADULT, 2m
2360-010	8000AP NONIN SPO2 SENSOR, PEDIATRIC, 2m
0741-000	8000J NONIN ADULT FLEX SENSORS WITH 25 WRAPS
4097-000	8000JFW NONIN ADULT REPLACEMENT WRAPS 25/PACK
0740-000	8008J NONIN INFANT FLEX SENSOR WITH 25 WRAPS
4774-000	8008JFW NONIN INFANT REPLACEMENT WRAPS 25/PACK

Part number	Description
0739-000	8001J NONIN NEONATAL FLEX SENSOR WITH 25 WRAPS
4777-000	8008JFW NONIN NEONATE REPLACEMENT WRAPS 25/PACK
7426-001	6000CA NONIN ADULT CLOTH DISPOSABLE 24/BX
7426-002	6000CP NONIN PEDIATRIC CLOTH DISPOSABLE 24/BX
7426-003	6000CI NONIN INFANT CLOTH DISPOSABLE 24/BX
7426-004	6000CN NONIN NEONATE CLOTH DISPOSABLE 24/BOX

Braun thermometry

Part number	Description
06000-005	Disposable probe covers (5,000 covers, packaged 200/box)
06000-801	Disposable probe covers (800 covers, packaged 200/box)
06000-800	Disposable probe covers (800 covers, packaged 200/box)

SureTemp Plus thermometry

Part number	Description
02895-000	Oral probe and well kit (9ft. / 2.7M)
02895-100	Rectal probe and well kit (9ft. / 2.7M)
05031-101	SureTemp Plus Disposable probe covers (1,000 covers, packaged 25/box)
05031-110	SureTemp Plus Disposable probe covers (10,000 covers, packaged 25/box)

Warranty

Welch Allyn warrants the product to be free of defects in material and workmanship and to perform in accordance with manufacturer's specifications for the period of two years from the date of purchase from Welch Allyn or its authorized distributors or agents.

The warranty period shall start on the date of purchase. The date of purchase is: 1) the invoiced ship date if the device was purchased directly from Welch Allyn, 2) the date specified during product registration, 3) the date of purchase of the product from a Welch Allyn authorized distributor as documented from a receipt from said distributor.

This warranty does not cover damage caused by: 1) handling during shipping, 2) use or maintenance contrary to labeled instructions, 3) alteration or repair by anyone not authorized by Welch Allyn, and 4) accidents.

The product warranty is also subject to the following terms and limitations: Accessories are not covered by the warranty. Refer to the directions for use provided with individual accessories for warranty information.

Shipping cost to return a device to a Welch Allyn Service center is not included.

A service notification number must be obtained from Welch Allyn prior to returning any products or accessories to Welch Allyn's designated service centers for repair. To obtain a service notification number, contact Welch Allyn Technical Support.

THIS WARRANTY IS IN LIEU OF ALL OTHER WARRANTIES, EXPRESS OR IMPLIED, INCLUDING BUT NOT LIMITED TO THE IMPLIED WARRANTIES OF MERCHANTABILITY AND FITNESS FOR A PARTICULAR PURPOSE. WELCH ALLYN'S OBLIGATION UNDER THIS WARRANTY IS LIMITED TO REPAIR OR REPLACEMENT OF PRODUCTS CONTAINING A DEFECT. WELCH ALLYN IS NOT RESPONSIBLE FOR ANY INDIRECT OR CONSEQUENTIAL DAMAGES RESULTING FROM A PRODUCT DEFECT COVERED BY THE WARRANTY.

